

S. BM. 1015







# **Bulletin of the British Museum (Natural History)**



Entomology series    Vol 43    1981

British Museum (Natural History)  
London 1982

### **Dates of publication of the parts**

No 1	.	.	.	.	.	.	.	.	.	.	.	.	.	.	.	.	.	.	30 July 1981
No 2	.	.	.	.	.	.	.	.	.	.	.	.	.	.	.	.	.	.	24 September 1981
No 3	.	.	.	.	.	.	.	.	.	.	.	.	.	.	.	.	.	.	29 October 1981
No 4	.	.	.	.	.	.	.	.	.	.	.	.	.	.	.	.	.	.	26 November 1981

ISSN 0524-6431

**Contents**  
**Entomology Volume 43**

	Page
No 1	
A revision of the genus <i>Usambilla</i> Sjöstedt (Orthoptera: Acridoidea) and its allies.	
N. D. Jago . . . . .	1
No 2	
The Asian, Australasian and Pacific Paraboloponinae (Homoptera: Cicadellidae). A taxonomic revision with a key to all the known genera of the subfamily.	
M. D. Webb . . . . .	39
No 3	
A revision of <i>Phyciodes</i> Hübner and related genera, with a review of the classification of the Melitaeinae (Lepidoptera: Nymphalidae).	
L. G. Higgins . . . . .	77
No 4	
A revision of six minor genera of Myrmicinae (Hymenoptera: Formicidae) in the Ethiopian zoogeographical region.	
Barry Bolton . . . . .	245



# Bulletin of the British Museum (Natural History)

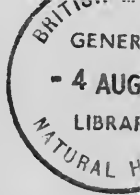

A revision of the genus *Usambilla* Sjöstedt  
(Orthoptera: Acridoidea) and its allies

N. D. Jago

Entomology series  
Vol 43 No 1

30 July 1988

The *Bulletin of the British Museum (Natural History)*, instituted in 1949, is issued in four scientific series, Botany, Entomology, Geology (incorporating Mineralogy) and Zoology, and an Historical series.

Papers in the *Bulletin* are primarily the results of research carried out on the unique and ever-growing collections of the Museum, both by the scientific staff of the Museum and by specialists from elsewhere who make use of the Museum's resources. Many of the papers are works of reference that will remain indispensable for years to come.

Parts are published at irregular intervals as they become ready, each is complete in itself, available separately, and individually priced. Volumes contain about 300 pages and several volumes may appear within a calendar year. Subscriptions may be placed for one or more of the series on either an Annual or Per Volume basis. Prices vary according to the contents of the individual parts. Orders and enquiries should be sent to:

Publications Sales,  
British Museum (Natural History),  
Cromwell Road,  
London SW7 5BD,  
England.

*World List* abbreviation: *Bull. Br. Mus. nat. Hist. (Ent.)*

© Trustees of the British Museum (Natural History), 1981

ISSN 0524-6431

British Museum (Natural History)  
Cromwell Road  
London SW7 5BD

Entomology series  
Vol 43 No 1 pp 1-38

Issued 30 July 1981



# A revision of the genus *Usambilla* Sjöstedt (Orthoptera: Acridoidea) and its allies

N. D. Jago

Centre for Overseas Pest Research, College House, Wrights Lane, London W8 5SJ

## Contents

Synopsis . . . . .	1
Introduction . . . . .	1
Material . . . . .	2
Key to genera in the Lentulidae . . . . .	3
<i>Chromousambilla</i> gen. n. . . . .	5
Key to species . . . . .	6
Males . . . . .	6
Females . . . . .	6
<i>Microusambylla</i> gen. n. . . . .	10
<i>Altiusambilla</i> gen. n. . . . .	12
<i>Rhainopomma</i> gen. n. . . . .	13
Key to species . . . . .	14
Males . . . . .	14
Females . . . . .	15
<i>Usambilla</i> Sjöstedt . . . . .	20
Key to species and subspecies . . . . .	22
Males . . . . .	22
Females . . . . .	24
References . . . . .	37
Index . . . . .	38

## Synopsis

The genus *Usambilla* Sjöstedt is redefined and fully revised with keys to the species and subspecies. Four new genera, ten new species and three new subspecies are described. *Altiusambilla modicicrus* (Karsch) is implicated in the defoliation of exotic *Pinus* plantations in northern Tanzania.

## Introduction

The genus *Usambilla* has been assumed to consist of a homogeneous group of small lentulid grasshoppers. The male genitalia of the group reveal, however, that five genera are involved within the old definition of *Usambilla*. *Chromousambilla* has male penis valves of great length (Fig. 12) which enable the diminutive male to remain firmly attached to the female during copulation without standing upon her in the usual acridid manner. The penis valves are curved and fit into the female spermathecal duct, which is of similar shape and length (Fig. 23). *Usambilla* sensu stricto has tapered valvulae (Fig. 150) with barbs on each side short of the apex, while *Rhainopomma* (Fig. 72) has these barbs situated apically. *Microusambylla* clearly has affinity with *Usambilla*, while *Altiusambilla* has affinity with *Rhainopomma* and *Mecostibus*.

Reports have recently been published (Whellan, 1975; 1976) of eumasticids and lentulids causing defoliation of exotic *Pinus*, particularly *P. patula*. In Malawi defoliation has been caused by *Plagiotriptus* Karsch (Eumastacidae) and members of the lentulid genera *Mecostibus*, *Nyassacris* and *Malawia*. In Tanzania attacks so far reported are from W. Kilimanjaro in December, 1975 at Msituni, the species involved being members of the genus *Chromothericles* Descamps (Eumastacidae) and the lentulid *Altiusambilla modicicrus*. This last is morphologically much

closer to *Mecostibus* than to the rest of *Usambilla* sensu stricto. Indeed the close similarity between the genera described in this paper may be due to convergent evolution. The external similarity between *Altiusambilla modicicrus* and *Rhainopomma montanum* is particularly striking.

### Material

Most of the material used for this study is in the collections of the first two institutions listed below. Museums loaning specimens have their abbreviations listed in the text as follows.

BMNH	British Museum (Natural History), London
COPR, London	Centre for Overseas Pest Research, London
NR, Stockholm	Naturhistoriska Riksmuseet, Stockholm
MNHU, Berlin	Museum für Naturkunde der Humboldt-Universität, Berlin
MRAC, Tervuren	Musée Royal de l'Afrique Centrale, Tervuren

Kenya series were immensely improved by the addition of COPR material collected recently by Dr I. A. D. Robertson and Mrs A. Robertson.

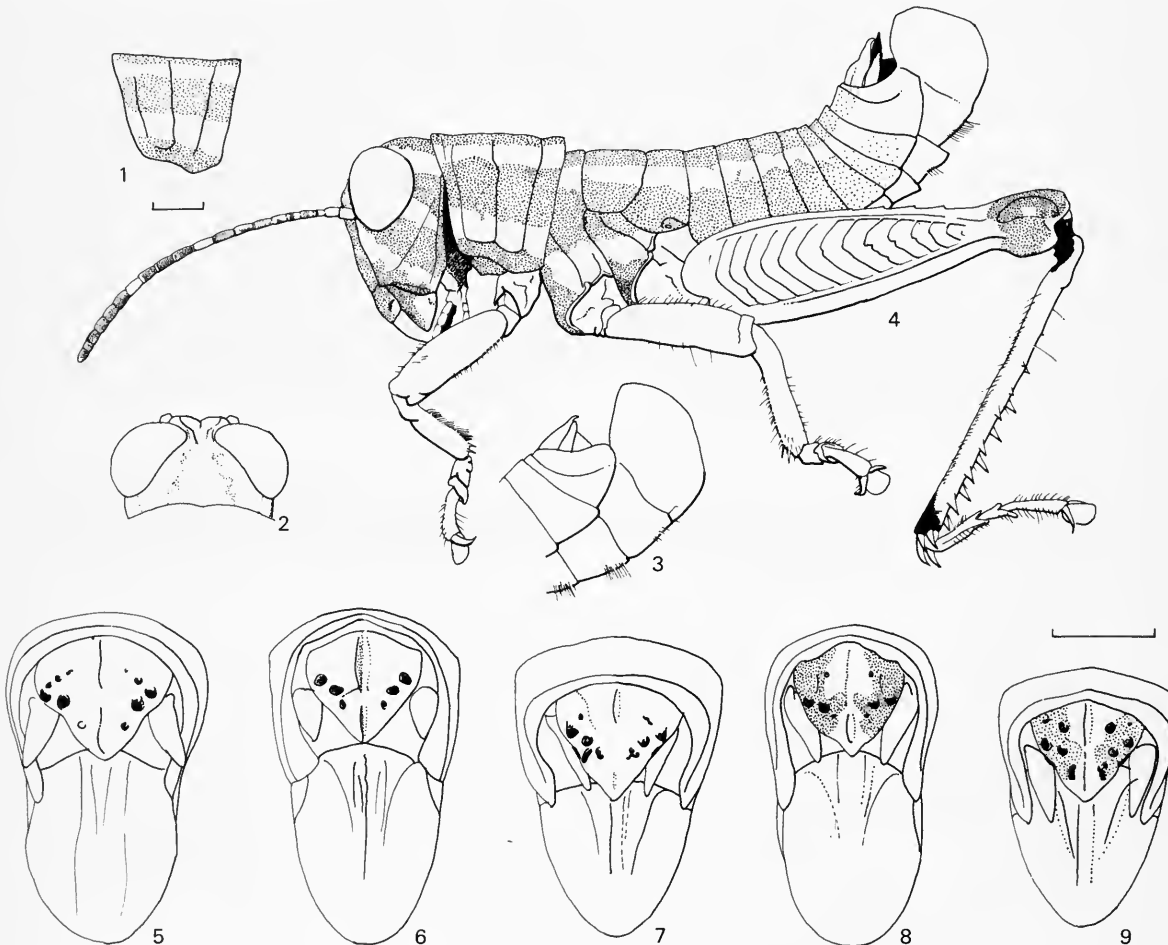

Figs 1-9 *Chromousambilla* species. 1, lateral aspect of pronotum of male *C. veseyi*. 2, dorsal aspect of head of male *C. latestriata*. 3, apex of male abdomen of *C. burtti*, lateral aspect. 4, entire male of *C. latestriata*. 5-9, dorsal aspect of male abdominal tip in (5) *C. burtti*; (6) *C. mweruensis*; (7) *C. robertsoni*; (8) *C. latestriata*; (9) *C. veseyi*. Scale lines represent 1 mm, that below Fig. 1 applies to Figs 1-4, that above Fig. 9 applies to Figs 5-9.



Key to genera in the *Lentulidae* (modified after Dirsh, 1965)

- 1 External apical spines of hind tibia absent. Head prognathous, or face vertical, or moderately sloping backwards . . . . . 2  
 – External apical spine of hind tibia present. Head conical or acutely conical, with face strongly sloping backwards or vertical . . . . . 16
- 2 Coxa of middle leg with large conical process, sometimes with a small tubercle . . . . . *MECOSTIBUS* Karsch  
 – Coxa of middle leg without process, sometimes with a small tubercle . . . . . 3
- 3 Ninth abdominal tergite of male with a median dorsal bifurcate appendage . . . . . 4  
 – Bifurcate appendage on mid-dorsal margin on ninth abdominal tergite absent . . . . . 5
- 4 Frons vertical or sloping forwards, slightly excurved or straight; fastigium of vertex not protruding. Body small but comparatively robust . . . . . *SHELFORDITES* Karny  
 – Frons sloping backwards, slightly incurved, fastigium of vertex and upper part of frons strongly protruding forwards. Body elongate, slender . . . . . *KALAHARICUS* Brown
- 5 Dorsum of pronotum crossed by four deep transverse sulci . . . . . *MECOSTIBOIDES* Dirsh  
 – Dorsum of pronotum crossed by three or fewer transverse sulci, or sulci not crossing disc at all . . . . . 6
- 6 Frontal ridge deeply sulcate below level of antennal sockets . . . . . 7  
 – Frontal ridge weakly sulcate to flat below level of antennal sockets . . . . . 8
- 7 Fastigium of vertex horizontal, triangular, seen from above, strongly projecting in front of eyes . . . . . *SYGRUS* I. Bolivar  
 – Fastigium of vertex sloping obliquely forwards; as seen from above (Fig. 27) weakly projecting in front of eyes . . . . . *MICROUSAMBILLA* gen. n. (p. 10)
- 8 Fastigium of vertex moderately or slightly projecting in front of compound eyes, as seen from above . . . . . 9  
 – Fastigium of vertex not projecting in front of eyes . . . . . *NYASSACRIS* Ramme
- 9 Hind femur not inflated bilaterally but strongly bilaterally compressed . . . . . 10  
 – Hind femur often stocky and inflated, not bilaterally compressed . . . . . 11
- 10 Interocular distance in males about as wide, in females twice as wide, as antennal scape. Fastigium of vertex in males, from above, seen to be excised at apex . . . . . *PARALENTULA* Rehn  
 – Interocular distance in males about twice, in females about four times, as wide as antennal scape. Fastigium of vertex, as seen from above, widely rounded or truncate . . . . . *LENTULA* Stål
- 11 Body moderately to very smooth. Frontal ridge moderately widened in upper part with weak carinulae and shallow depression. Male supra-anal plate with black tubercles (Figs 35, 50–54, 94–100) . . . . . 13  
 – Body strongly rugose. Frontal ridge strongly widened in upper half, strongly carinate. Supra-anal plate lacking tubercles on disc. . . . . 12
- 12 Hind femora stocky, length to depth ratio R about 3.2. Compound eyes strongly inflated, width across eyes to pronotal width ratio 3 : 2. Length of pronotum at dorsal midline shorter than its width. Supra-anal plate and ninth abdominal tergite of male lacking any callosities . . . . . *KARRUACRIS* Dirsh  
 – Hind femur slender, ratio R about 4.0. Compound eyes only moderately inflated, width across eyes rather less than maximum pronotal width as seen from above. Pronotal length at midline equal to its greatest width. Supra-anal plate and ninth abdominal tergite with small marginal callosities. . . . . *MALAWIA* Dirsh
- 13 Hind femora of males yellow or greenish yellow with genicular part black. Eyes protruding, red in males. Penis valves elongate, flagelliform (Fig. 15). Female ventral ovipositor valves shovel-shaped (Fig. 24) . . . . . *CHROMOUSAMBILLA* gen. n. (p. 5)  
 – Hind femora green, brown or yellowish brown with genicular part dark brown, light brown, blue or some other colour other than black. Eyes in males never red. Penis valves barbed (Figs 38, 72, 133). Female ventral ovipositor valves pointed, tapered (Figs 147, 148) . . . . . 14
- 14 Margin of abdominal tergite 9 in males bearing one or two pairs of black tubercles (Fig. 35). Penis valves apically attenuate with barbs apical. Anterior penis valves short, auricular (Fig. 37). Posterior part of median pronotal carina raised into a large tubercle (Fig. 36) in females. . . . . *ALTIUSAMBILLA* gen. n. (p. 12)  
 – Rear margin of tergite 9 of abdomen without conical black tubercles. Penis valves tapering, conical in dorso-posterior view (Figs 72, 133). Anterior penis valves flat, vertically orientated and racket-shaped (as in Fig. 12) . . . . . 15

- 15 Male supra-anal plate with eight to twelve strong black tubercles on the disc (Figs 50, 54). Male penis valves with apical barbs (Figs 64, 67, 68, 72) . . . . . **RHAINOPOMMA** gen. n. (p. 13)
- Male supra-anal plate with eight to ten strong black tubercles on its disc (rarely as in Figs 97, 99, with pair of weak ones making 12 in all). Male penis valves with pre-apical lateral barbs (Figs 133, 135, 138, 141, 142, 145, 150) . . . . . **USAMBILLA** Sjöstedt (p. 20)
- 16 Fastigium of vertex not projecting in front of eyes, sloping strongly forwards and forming part of face . . . . . **EREMIDIUM** Karsch
- Fastigium of vertex projecting or strongly projecting in front of eyes, horizontal . . . . . 17
- 17 Basal angles of fastigium of vertex detached from eyes and projecting laterally; body strongly rugose . . . . . **SWAZIACRIS** Dirsh
- Basal angles of fastigium of vertex of normal shape, touching eyes. Body smooth or only moderately rugose . . . . . 18
- 18 Frontal ridge, in profile, more or less strongly projecting in upper half or upper third . . . . . 19
- Frontal ridge, in profile, straight, not projecting in upper part . . . . . 22
- 19 Fastigium of vertex elongate. Antennae ensiform, serrated . . . . . **DEVYLDERIA** Sjöstedt
- Fastigium of vertex shorter. Antennae phylliform or filiform . . . . . 20
- 20 Frontal ridge in upper projecting part lamelliformly compressed, below shallowly sulcate . . . . . 21
- Frontal ridge sulcate along whole length . . . . . **BASUTACRIS** Dirsh
- 21 Antennae very short, phylliform, compressed and strongly widened, about four times longer than wide. Fastigium of vertex with lateral carinulae. Pronotum shorter than its width. Body rugose . . . . . **KARRUIA** Rehn
- Antennae narrow, almost filiform. Fastigium of vertex without carinulae. Pronotum longer than its width. Body smooth . . . . . **GYMNIIDIUM** Karsch

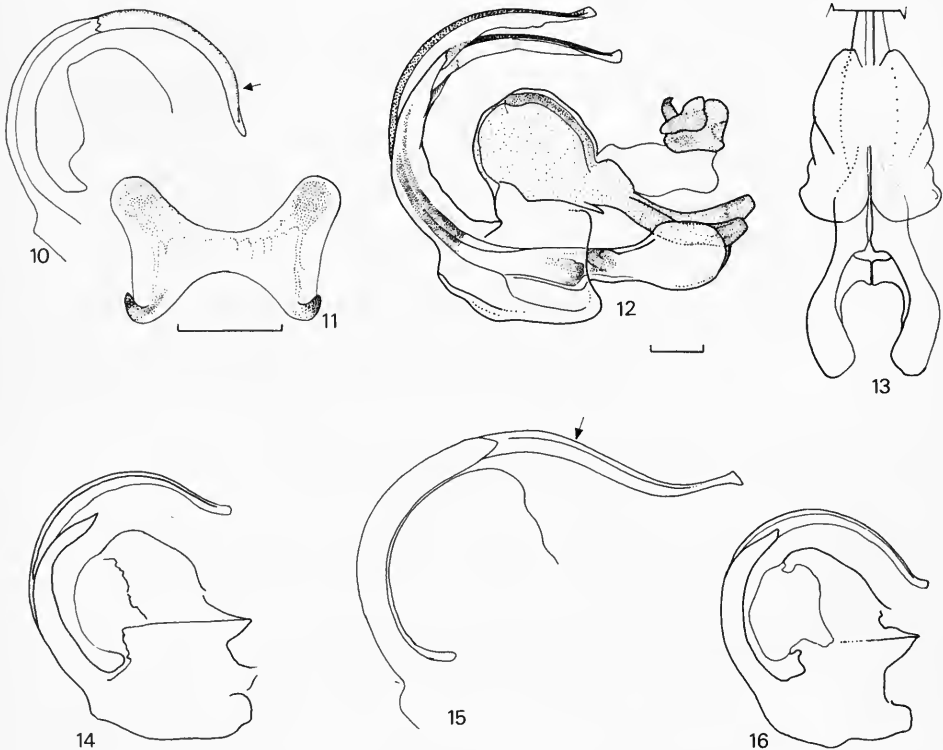

**Figs 10–16** *Chromousambilla* species, male phallic complex. 10, 14–16, lateral aspect of aedeagal valves of (10) *C. robertsoni*; (14) *C. mweruensis*; (15) *C. burtti*; (16) *C. veseyi*. 11, epiphallus of *C. robertsoni*. 12, lateral aspect of right side of entire complex in *C. latestriata*. 13, ventral aspect of circular rami and anterior valves of penis of *C. latestriata*. Scale-lines represent 0.5 mm—that below Fig. 12 applies to 10 and 12–16; that below 11 to that figure. Small arrows on Figs 10 and 15 show equivalent position on each set of valvulae.

- 22 Fastigium of vertex comparatively short, angular. Body slender, moderately elongate . . . . . 23  
 – Fastigium of vertex elongate, angular or narrow parabolic, with obtusely angular apex. Body slender and very elongate . . . . . 24
- 23 Fastigium of vertex broadly angular, wider than longest diameter of eye. Frontal ridge sulcate along whole length. . . . . *QACHASIA* Dirsh  
 – Fastigium of vertex narrowly angular, much narrower than longest diameter of eye. Frontal ridge in upper fourth compressed, without sulcus, sulcate below . . . . . *HELWIGACRIS* Rehn
- 24 Fastigium of vertex angular. Frontal ridge above base of antennae low, compressed. Antennae thick, strongly and regularly narrowing towards apex, weakly compressed in basal half. Body smooth . . . . . *BETISCOIDES* Sjöstedt  
 – Fastigium of vertex narrow parabolic. Frontal ridge above base of antennae produced, strongly lamelliformly compressed. Antennae very wide, strongly compressed laterally, only slightly narrowed at apex. Body rugose . . . . . *BACTERACRIS* Dirsh

### *CHROMOUSAMBILLA* gen. n.

Type-species: *Adolfia latestriata* Ramme.

**DIFFERENTIAL DIAGNOSIS.** *Male.* Separable from closely related genus *Usambilla* by great length of aedeagal valves, which lack barbs (Figs 10, 14, 15, 16). (Proximal section of female spermathecal duct (Fig. 23) correspondingly stiffened and elastically thickened for a distance corresponding to length of aedeagal valves distal to their basal attachment below greatly inflated cingular arch.) In life aedeagal valves curled over greatly inflated membranous arch of cingulum (Fig. 12), their tips touching ectophallic membrane posterior to epiphallus. Cingular rami also very unusual, small and parallel, being approximated on mid-line so that they lie between flattened anterior (internal) valvulae of penis (Figs 12, 13). Epiphallus very small and simple, lacking ancorae, function of which taken over by hook-like development of ventro-lateral corners of epiphallus (Fig. 11). Whole apparatus housed within enlarged pod-like subgenital plate (Figs 4, 8).

Fastigial depression gently concave, its mid-frontal edge being notched as viewed from above (Fig. 2). Inter-ocular groove well developed, short and wider capitad than caudad. Differs from that of *Usambilla sensu stricto*, which is in form of an elongated slot (Fig. 92) or a slightly wider parallel-sided groove. Body shape like that of *Usambilla* (Fig. 4).

Supra-anal plate bears callosities of type found in *Usambilla*, but proportions of supra-anal plate to sub-genital plate clearly differ (Figs 8, 94–101).

*Female.* Ventral valves of ovipositor (Fig. 24) straight-edged; median process of subgenital plate almost level with their tips.

*Coloration.* General colouring very uniform in genus. Male eyes vermilion, frons blackish; three lateral light yellow or whitish stripes on side of head (Fig. 4). Upper pair of light stripes continued along thorax and abdomen. Subgenital plate yellow. Posterior femora yellow to yellow-green, knees black; posterior tibiae yellow-green, sooty at extreme tip and near knee. Dark body stripes blue to blue-black or brown. Female more variable, but in general (Figs 17, 20, 21, 26) lighter brown to olivaceous dorsally, with light banding like that of male, but with uppermost of light (dorso-lateral) bands weak and lower one on pronotum strong. Broad dark lateral band variable in intensity. Light bands yellow or creamy colour. Posterior leg colour as for male but less intense. Body colour of female *C. veseyi* exceptional in that body and head olive green dorsally and uppermost dorso-lateral light bands bright yellow. Lateral dark bands very black so that female of this species resembles male more closely than do those of rest of genus.

There is great instability in the callosities of the male supra-anal plate and too much variation for this feature to be reliable diagnostically.

**DISCUSSION.** The genus is known only from NW. Zambia and Tanzania. *C. mweruensis* in the Mweru Wa Ntipa and Malagarasi R. drainages, which were once part of the Congo R. drainage basin before the formation of Lake Tanganyika by rifting, may be indicative of the great antiquity of the genus. Each species seems confined to the wettest eco-zones of a separate drainage basin. Some of these, as in the Dodoma area or Mpwapwa basin, are closed internal drainages. Others like the Ruaha R. valley are open systems, but have no ecological bridges suitable for the genus by which they can enter other drainages.

**Key to species****Males**

- 1 Antennae fully twice length of head and pronotum. Large species with blue/black dark longitudinal stripes on body. Light longitudinal stripes white to cream.  
Subgenital plate larger in profile (Fig. 3) than other species in genus (Fig. 4) and narrowed at level of cercus apices as seen from above (Fig. 5) . . . . . *C. burtti* sp. n. (p. 9)
- Antennae clearly less than twice length of head and pronotum. Dark body stripes grey, blue or Prussian blue to blue-green. Light longitudinal stripes yellow . . . . . 2
- 2 Supra-anal plate laterad, at level of cercus apices (Figs 8, 9), black in addition to black callosities . . . . . 3
- Supra-anal plate without black areas in addition to black callosities (Figs 6, 7) . . . . . *C. mweruensis* sp. n. (p. 9)
- 3 Pronotum and more particularly subgenital plate clothed with sparse hairs (Fig. 8). Black area of supra-anal plate broadly pigmented to base . . . . . 4
- Pronotum and subgenital plate almost without hairs (Fig. 9). Black areas of supra-anal plate not reaching base of plate . . . . . *C. robertsoni* sp. n. (p. 10)
- 4 Lower light yellow band on pronotum laterad, roughly equal in depth to dark band immediately above it (Fig. 1) . . . . . *C. veseyi* sp. n. (p. 8)
- Lower light yellow band on pronotum laterad, half depth of dark band immediately above it (Fig. 3) . . . . . *C. latestriata* (Ramme) (p. 6)

**Females**

- 1 Median dorsal carinula of pronotum elevated and clear to weak but entire . . . . . 2
- Median dorsal carinula of pronotum weak, flattened (Fig. 22).  
Colouring akin to that of males with median dorsal part of body olive brown and dorso-lateral yellow band visible and entire as far back as 8th abdominal tergite (Fig. 19) . . . . . *C. veseyi* sp. n. (p. 8)
- 2 Large species (Fig. 21). Pronotal side stripe white, bordered above and below by black. Antennae 1.50 times longer than head and pronotum together . . . . . *C. burtti* sp. n. (p. 9)
- Smaller species. Pronotal side stripe less heavily delineated or even absent. Antennae less than 1.45 times longer than head and pronotum together . . . . . 3
- 3 Lower outer lobe of knee of hind femur uniformly creamy or light brown in colour. Ratio of length of antennae to that of head and pronotum (R) about 1.0 or 1.4. Dorso-lateral yellow pronotal line very weak or absent (Figs. 20 and 26) . . . . . 4
- Lower outer lobe of knees of hind femur with additional black markings. Ratio (R) about 1.2. Dorso-lateral yellow pronotal line narrow but usually clear (Fig. 17) . . . . . *C. latestriata* (Ramme) (p. 6)
- 4 Brownish insects (Fig. 26); body length less than 18 mm. Ratio of antennal length to length of head and pronotum (R) about 1.0 . . . . . *C. robertsoni* sp. n. (p. 10)
- Olivaceous or brownish insects (Fig. 20); body length more than 18 mm. Ratio (R) 1.4 . . . . . *C. mweruensis* sp. n. (p. 9)

***Chromousambilla latestriata* (Ramme) comb. n.**

(Figs 2, 4, 8, 12, 13, 17, 18, 24, 25)

*Adolfia latestriata* Ramme, 1929: 307, fig. 29c. Holotype ♂, TANZANIA: Ukimbu, Nkila, 20–21.viii.1899 (Glauning) (MNHU, Berlin) [examined].

DIFFERENTIAL DIAGNOSIS. Male with supra-anal plate blackened laterally (Fig. 8), thus differing from *C. burtti* and *C. mweruensis*. Aedeagal valves longer than those of *C. robertsoni* or *C. veseyi* (see Figs 10, 12, 16); in former, pronotum and subgenital plate almost lack hairs, and black areas on supra-anal plate do not extend to its base. In contrast, *C. latestriata* and *C. veseyi* are sparsely but clearly hirsute on pronotum and subgenital plate, and black areas of supra-anal plate are as in Figs 8, 9. *C. latestriata* differs from *C. veseyi* in proportions of lateral pronotal bands (Figs 1, 3).

Female differs markedly in colouring from *C. veseyi* (see key) and lacks well-developed median pronotal carina of *C. burtti*. Lower outer lobe of knee of posterior femora with dark spots, thus differing from uniformly light brownish lobe of *C. robertsoni* and *C. mweruensis*.

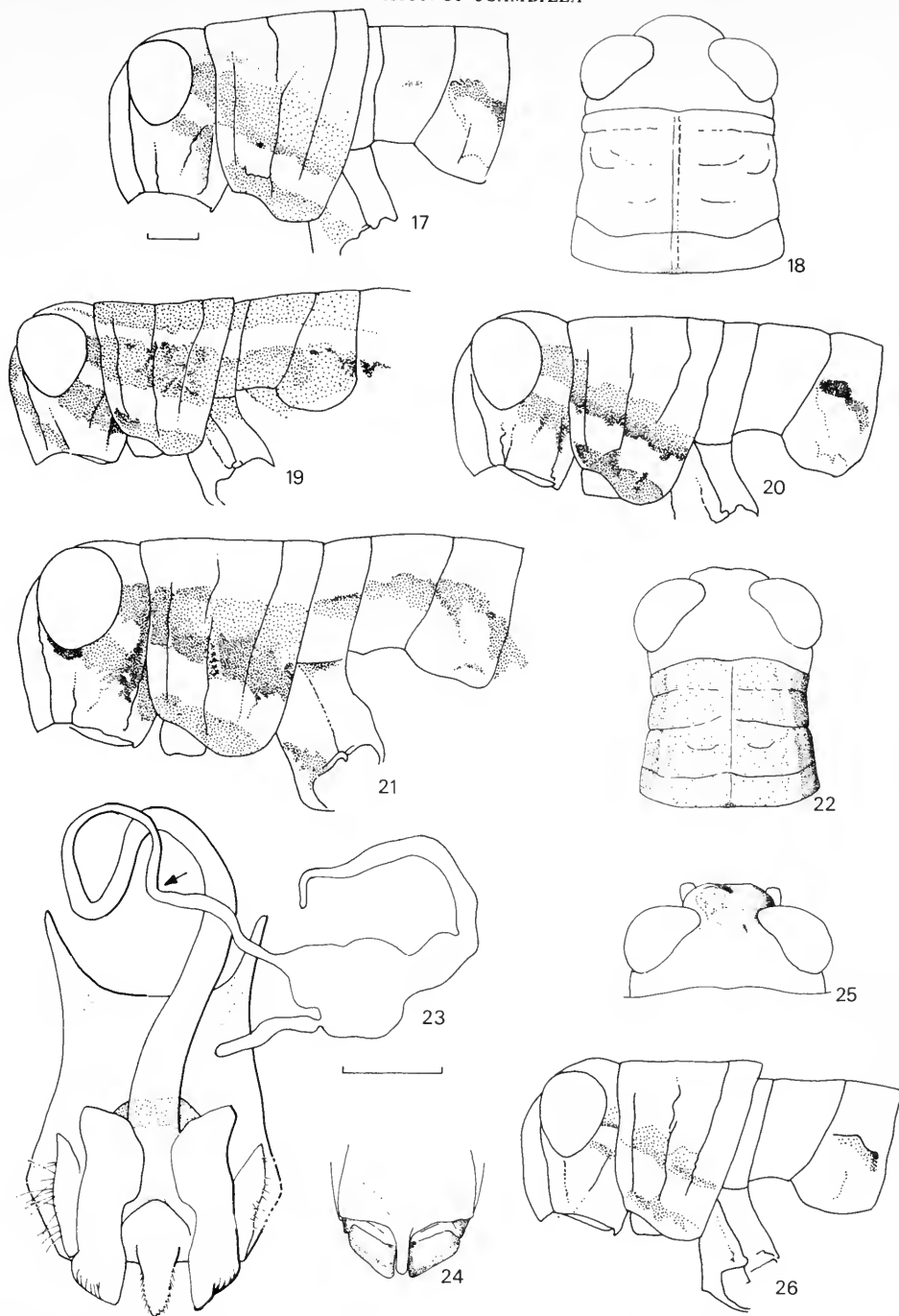

**Figs 17–26** *Chromousambilla* species, females. 17, lateral aspect of head and thorax of *C. latestriata*. 18, dorsal aspect of head and pronotum of *C. latestriata*. 19–21, lateral aspect of head and thorax of (19) *C. veseyi*; (20) *C. mweruensis*; (21) *C. burtti*. 22, dorsal aspect of head and pronotum of *C. veseyi*. 23, dissected display of ventral ovipositor valves (*vv*) and spermatheca showing point distal to which duct is non-sclerotised (arrow) and apical sac plus preapical diverticulum. 24, ventral valves of ovipositor, from below, of *C. latestriata*. 25, dorsal aspect of head and pronotum of *C. latestriata*. 26, lateral aspect head and thorax *C. robertsoni*. Scale line under Fig. 17 represents 1 mm and applies to all except Figs 23 and 24, to which 1 mm scale line under Fig. 23 applies.

## MEASUREMENTS

	Males		Females	
Head width	(11)	3.4-3.7, 3.52	(8)	4.1-4.4, 4.26
Antenna length	(9)	5.6-6.4, 6.72	(7)	6.0-7.2, 6.71
Posterior femur length	(11)	7.1-8.3, 7.88	(7)	9.2-10.2, 9.73
Posterior femur depth	(11)	2.0-2.3, 2.11	(7)	2.5-2.9, 2.68
Body length	(11)	12.0-14.1, 13.09	(8)	16.8-18.8, 17.81

## MATERIAL EXAMINED

**Tanzania:** 4 ♂, 8 ♀, Rukwa, Kapombo Hill, 25.iv.1958 (*Vesey-FitzGerald*) (BMNH); 1 ♂, 1 ♀, Ufipa, Ilemba gap, 12.iii.1959 (*Vesey-FitzGerald*) (BMNH); 11 ♂, 10 ♀, Ufipa plateau, Mkundi, 26 km NNW. of Sumbawanga, 16-27.v.1966 (*Jago*) (5 ♂, 2 ♀; rest COPR, London); 1 ♂, 2 ♀, Rukwa valley, Red Locust Camp, Musa, 26-27.ix.1964 (*Jago*) (BMNH).

**DISCUSSION.** This species was originally described from 'Ukimbu (S.O.-Tanganyika)'. At that time 'Tanganyika' was applied to a region embracing parts of what are now Katanga, northern Zambia and SW. Tanzania, and 'Ukimbu' was an area to the east of L. Rukwa. The COPR collections include material from the Rukwa valley and Ufipa plateau west of L. Rukwa. The females from the valley floor have dark colouring with two light yellowish body stripes laterad, the rest of the insect being dark greenish. Females from the plateau lack the upper pair of lighter bands laterad but are lighter insects overall.

A collection was made of the plant association characterising the herb cover of the habitat. This insect occurred together with *Usambilla haematogramma* and was particularly abundant at the base of old termite hills at the edge of a forestry plantation. The plants were kindly identified in 1967 at the East African Herbarium by S. P. Kibuwa; the species were *Bidens stephia* (Steetz) Scherff, *Erlangea* sp. near *E. laxa* S. Moore (Compositae); *Hypoestes verticillaris* R. Brown (Acanthaceae); *Pycnostachys* (?) *stuhlmanni* Guerke (Labiateae); *Pseudarthria hookeri* Wight & Arnott (Papilionaceae); *Achyranthes aspera* L. (Amaranthaceae); *Physalis peruviana* L. (Solanaceae).

Like *U. haematogramma*, *C. latestriata* seems to occur in a plant community which is structurally part of a woodland subclimax. It does not live in the forest or grassland and would therefore seem to be an insect adapted to a transient ecosystem. The Ufipa forests seem to be at a curious senescent stage in which many of the broad-leaved trees are dying, leaving many areas with tree euphorbias as dominants. Local ecologists implicate climatic change and the effects of man in accelerating the decline in this unique forest mosaic.

*Chromousambilla veseyi* sp. n.

(Figs 1, 9, 16, 19, 22)

Holotype ♂, **Tanzania:** Ruaha. Nat. Park, riverine, 15.iii.1966 (*Vesey-FitzGerald*) (BMNH).

**DIFFERENTIAL DIAGNOSIS.** Male with supra-anal plate (Fig. 9) blackened laterally, thus differing from *C. burtti* and *C. mweruensis*. Like latter, however, in having short aedeagal valvulae (Figs 14, 16). Unlike *C. robertsoni* in having moderately hirsute pronotum and subgenital plate. Dark body stripes definitely bluish black, not black or dark brown. Light body stripes golden yellow, differing in proportions from *C. latestriata* (see Figs 1, 3; also key, p. 6).

Female differs from all other species (Fig. 19): generally darker dorsally and olive green with clear dorso-lateral yellow side stripes. Dark lateral stripes black.

## MEASUREMENTS

	Males		Females	
	Holotype			
Head width	3.5	3.6	4.1	4.4
Antenna length	6.9	7.6	7.6	7.9
Posterior femur length	7.8	8.1	9.7	10.3
Posterior femur depth	2.1	2.2	2.6	2.8
Body length	14.1	13.2	16.2	15.9

## MATERIAL EXAMINED

Paratypes. **Tanzania**: 1 ♂, 2 ♀, same data as holotype (1 ♂, 1 ♀ in COPR, London; 1 ♀ in BMNH).

DISCUSSION. This new species is named after the late L. D. E. F. Vesey-FitzGerald, a close friend and colleague. The species is unique in having the male and female with similar bright colour patterns.

*Chromousambilla burtti* sp. n.

(Figs 3, 5, 15, 21)

Holotype ♂, **Tanzania**: Kikombo, Mpwapwa, 17.iv.1947 (*E. Burtt*) (BMNH).

DIFFERENTIAL DIAGNOSIS. Both sexes distinguished at once by larger size. Antennae in both sexes longer proportionately than other species, twice length head and pronotum in male, 1.5 times in female. Supra-anal plate of male lacking areas of black pigmentation (Fig. 5), thus differing from *C. latestriata*, *C. veseyi* and *C. robertsoni*. Dark body stripes of male dark brown; light body stripes dull cream. Female (Fig. 21) with dark brown side stripes with other darker regions black. Dark side stripe on metathorax and first abdominal tergite strongly arched. Back of female pronotum often green. Male and female with pronounced though slender median dorsal carinula.

Male genitalia (Fig. 15) very long and aedeagus narrowed pre-apically with an oblique tip. Whole complex enclosed in large pod-shaped sub-genital plate (Fig. 3).

## MEASUREMENTS

	Male holotype	Female allotype
Head width	3.9	5.0
Antenna length	10.5	10.3
Posterior femur length	9.6	11.9
Posterior femur depth	2.6	3.3
Body length	15.7	21.2

## MATERIAL EXAMINED

Paratypes. **Tanzania**: 2 ♂, 1 ♀ allotype and 2 ♀, same data as holotype (1 ♂, 1 ♀ (allotype), 1 ♀ BMNH; 1 ♂, 1 ♀ COPR, London); 1 ♂, 1 ♀, Kikombo, Mpwapwa, 20.iv.1947 (*E. Burtt*) (♀, BMNH; ♂ COPR, London); 1 ♂, 2 ♀, Kikombo, Mpwapwa, 18.iv.1947 (*E. Burtt*) (BMNH).

DISCUSSION. The species is named after the late Eric Burtt who did so much to improve our knowledge of the acridid fauna of central and eastern Africa.

*Chromousambilla mweruensis* sp. n.

(Figs 6, 14, 20)

Holotype ♂, **Zambia**: Mporokosa distr., Mweru wa Ntipa, [8-13.]vii.1952 (*Uvarov*) (BMNH).

DIFFERENTIAL DIAGNOSIS. Male differs from all other species, except *C. burtti*, in having supra-anal plate free of black shading laterally (see Figs 6, 7). Aedeagal valves resemble *C. veseyi* (see Figs 14, 16), but this differs on supra-anal plate facies. Male dark body stripes blue-black, those of *C. burtti* being black. Latter also bigger species with longer antennae (ratio of antennal length to length of head plus pronotum 2.0 in males, 1.5 in females); antenna in *C. mweruensis* having equivalent ratios for male 1.8 and female 1.0.

## MEASUREMENTS

	Males		Females	
	Holotype			
Head width	3.5	3.8	4.5	4.3
Antenna length	6.9	7.7	8.1	9.4
Posterior femur length	8.6	8.2	10.2	9.4
Posterior femur depth	2.3	2.2	2.8	3.0
Body length	16.1	14.5	19.5	21.1

## MATERIAL EXAMINED

Paratypes. **Zambia**: 1 ♀, same data as holotype (BMNH). **Tanzania**: 6 ♂, 2 ♀, 35.4 km W. of Kahama, Mkwemi, 14–29.iii.1947 (*E. Burt*) (1 ♂, 1 ♀ COPR, London; rest BMNH); 4 ♂, 35.4 km W. of Kahama, Mkwemi, [xii.1946–ii.1947] (*E. Burt*) (BMNH); 2 ♂, Old Shinyanga, 1.ii.1947 (*E. Burt*) (BMNH); 2 ♀, 16.1 km N. of Ussure, on Msigiri rd, 12.iv.1936 (*E. Burt*) (BMNH).

DISCUSSION. The species name originates from the Mweru wa Ntipa area of Zambia.

*Chromousambilla robertsoni* sp. n.

(Figs 7, 10, 11, 26)

Holotype ♂, **Tanzania**: 70.8 km N. of Dodoma, nr Meia Meia, [16–18.]vi.1967 (*Jago*) (BMNH).

DIFFERENTIAL DIAGNOSIS. Aedeagal valvulae (Fig. 10) of intermediate length, pointed apically like *C. latestriata* and *C. veseyi*, with black patches laterad on supra-anal plate, but these areas not reaching broadly to base of plate. Male colour and body markings like those of *C. latestriata*, but lower outer lobe of hind knee mostly white with limited dark spots (unlike *C. latestriata* in which this lobe extensively mottled with black). Pronotum and subgenital plate almost without hairs. Female almost uniform dull brown (Fig. 26) with weakly differentiated creamy diagonal side stripe. Hind femora dull olive to yellow with lower outer knee lobe pale brown, immaculate (unlike *C. latestriata* which has dark spots on this area). Ratio of antenna length to length of pronotum plus head about 1.8 in males and 1.4 in females; antennae being shorter in proportion than any other species.

## MEASUREMENTS

	Males		Females	
Head width	(12)	3.2–3.5, 3.41	(2)	4.1 4.1
Antenna length	(11)	6.2–7.7, 6.78	(2)	6.6 6.3
Posterior femur length	(12)	7.4–9.1, 8.03	(2)	9.8 9.4
Posterior femur depth	(12)	1.9–2.4, 2.16	(2)	2.9 2.7
Body length	(12)	11.0–13.0, 12.20	(2)	13.1 17.4

## MATERIAL EXAMINED

Paratypes. **Tanzania**: 10 ♂, 2 ♀, same data as holotype (9 ♂, 1 ♀, BMNH; 1 ♂, 1 ♀, COPR, London).

DISCUSSION. The species is named for Dr I. A. D. Robertson and his wife Ann who are formidable collectors of acridids. The species occurred in rather dry *Acacia* woodland in the same biotope as *Physocrobylus burtti* Dirsh (described in Jago, 1978).

*MICROUSAMBILLA* gen. n.

(Figs 27–33)

Type-species: *Usambilla cylindricollis* Ramme.

DIFFERENTIAL DIAGNOSIS. *Male*. Vertex with narrow selliform groove opening forward into disc-shaped fastigium (Fig. 27). Pronotum rounded above, lacking median carina (Fig. 29). Antennae slightly flattened, not widened and about 1.25 times length of head and pronotum. Ninth abdominal tergite deeply excavate (Fig. 28), bearing black tubercles on either side of median emargination. Supra-anal plate simple, triangular, bearing two large submarginal tubercles laterally and up to three pairs of small tubercles on disc. Penis complex like that in *Usambilla*, with large racket-shaped anterior valves and aedeagus bearing a single pair of pre-apical lateral teeth (Figs 32, 33). Epiphallus simple, ancorae (Fig. 31) weak and forwardly directed, ventro-lateral lophus (Figs 30, 31) at right angles to disc and with single apical hook. Hind femur 3.8 times longer than deep, rather slender.

*Female*. Head as seen from above very similar to that of male. Pronotum with traces of median dorsal carina. Antenna about 1.25 times length of head and pronotum. Ventral ovipositor valves slender, pointed. Hind femora slender, like those of male.

*Coloration*. General colour pattern of both sexes similar (Fig. 29). Light brown above, dark brown laterally. Dorso-laterally, pair of faint whitish stripes, side lobe of pronotum with another arcuate band of same colour but twice as deep. Hind femora olive, brown above. Hind tibiae brown, sooty below.



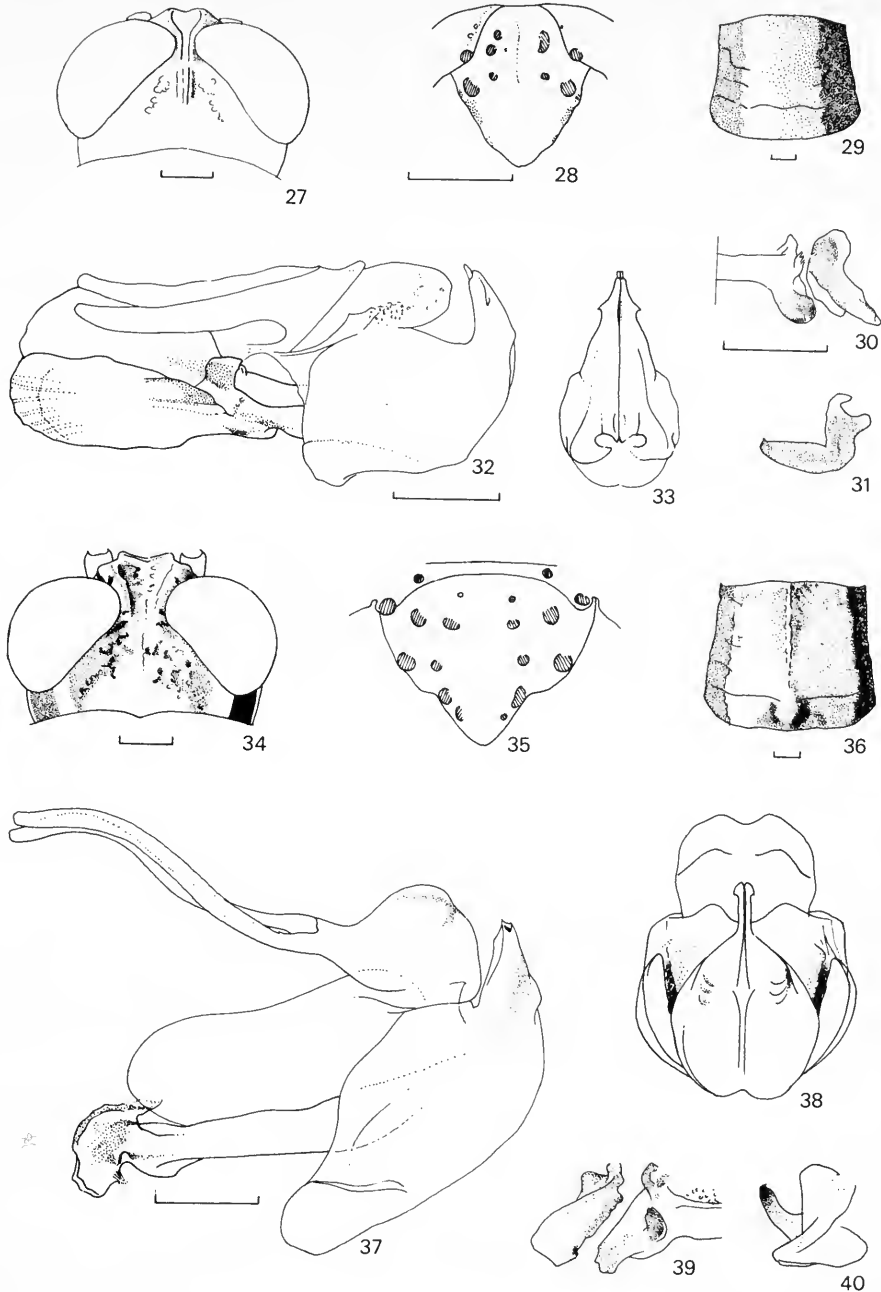

**Figs 27–33** *Microusambilla cylindricollis*. 27, dorsal aspect of male head. 28, dorsal aspect of male supra-anal plate. 29, dorsal aspect of female pronotum. 30, right side, epiphallus and lateral plate, male. 31, epiphallus of male, right side. 32, entire male phallic complex (epiphallus removed), lateral oblique view, left side. 33, cingular rami and apical valvulae, rear aspect. All scale lines represent 0.5 mm.

**Figs 34–40** *Altiusambilla modicicrus*. 34, dorsal aspect of male head. 35, dorsal aspect of male supra-anal plate. 36, dorsal aspect of female pronotum. 37, entire male phallic complex, apical valvulae, rear aspect. 39, left side of epiphallus and lateral plate, male. 40, right side of epiphallus. Scale line under Fig. 37 represents 0.5 mm and applies to Figs 35, 37–40. Other scale lines represent 0.5 mm.

DISCUSSION. The genus is monotypic. It is morphologically close to *Sygrus* from which it differs in having a flattened sloping fastigium of the vertex and a weaker system of black nodules on the male ninth tergite. *Sygrus* also has a more definite dorsal pronotal carinula (see key, p. 3). In future, when further material is available, it may be best to unite *Sygrus* and *Microusbilla* under one genus.

*Microusbilla cylindricollis* (Ramme) **comb. n.**

*Usambilla cylindricollis* Ramme, 1929: 302, fig. 27a. Holotype ♂, ZIMBABWE: Mashonaland, Chirinda forest, 1150 m, 22.ii.1907 (C. F. M. Swynnerton) (BMNH) [examined].

MEASUREMENTS

	Male	Female
Head width	3.0	4.9
Posterior femur length	7.7	9.0
Posterior femur depth	2.0	2.0
Body length	12.1	14.2

MATERIAL EXAMINED

Zimbabwe: 2 ♂, 3 ♀, Monarch Mine, Umtali, 1213 m, 6.iv.1945 (N. C. E. Miller) (BMNH); 6 ♀, same data but 7.iv.1945 (BMNH).

*ALTIUSAMBILLA* **gen. n.**

(Figs 34–40)

Type-species: *Lentula modicicrus* Karsch.

DIFFERENTIAL DIAGNOSIS. *Male*. Head and fastigium rugulose (Fig. 34) with transverse carinulae in depressed anterior part of fastigium. Upper part of frons, between antennal bases concave and widened. Groove of vertex ending just behind narrowest approximation of compound eyes dorsally, two oblique ridgelets separating it from the highly pitted occiput. Pronotum smoothly rounded above, median carinula being weak but present along whole length of disc. Dorso-lateral light pronotal stripe very narrow while ventral band on pronotal side lobe very deep, extending from pronotal margin one-third of way up side lobe. Posterior margin of ninth abdominal tergite gently concave, bearing one and sometimes two black tubercles on each side (Fig. 35). Supra-anal plate without marginal callosities of the *Rhainopomma* type (Figs 50–54) but with at least six pairs of tubercles on the disc and base of distal appendage (Fig. 35). Phallic complex like that in *Lentula*, with small auricular anterior penis valves (Fig. 37). Penis valves styliform with apical barbs (Fig. 38). Epiphallus with no ancorae and with lophal lobes slender, turned upwards at 45° to epiphallic disc (Fig. 40) and ruggedly hooked at tip (Fig. 39). Length to depth ratio of hind femur 4.

*Female*. Angular differentiation of frontal groove and fastigium more pronounced than in male, latter being pitted and sloping forward at 45° to horizontal body axis. Lateral body stripes relatively undifferentiated. Dorsal median pronotal carina forming a large hump in the metazona (Fig. 36). Tergites of abdomen sharply carinulate. Tips of ventral ovipositor valves quadrilateral with acutangular apices.

*Coloration*. Fore and midlegs yellow green. Hind femur yellow green; knee lenules blackish, rest brown. Hind tibiae pale bluish yellow-green, sooty apically. Generally olivaceous brown or greenish with creamy pronotal stripes in males. Dark brown to blackish side stripe in males and females from behind eye to side of first abdominal segment. On latter segment often black, continuing as broken black zig-zag on each side to abdominal segment 6.

*Altiusambilla modicicrus* (Karsch) **comb. n.**

*Lentula modicicrus* Karsch, 1896: 280. Holotype ♂,

TANZANIA: Madjame, Mt Kilimanjaro (MNHU, Berlin) [examined].

MEASUREMENTS

	Males	Females
Head width	(64) 2.5–3.0, 2.69	(42) 3.0–3.5, 3.24
Posterior femur length	(60) 6.0–7.0, 6.55	(39) 7.8–9.3, 8.67
Posterior femur depth	(62) 1.5–1.8, 1.68	(39) 2.0–2.4, 2.20
Body length	(59) 10.9–13.4, 12.11	(39) 13.1–17.1, 15.98

## MATERIAL EXAMINED

**Tanzania:** 1 ♂, Moshi, 18.xi.1943 (*E. Burt*) (BMNH); 3 ♀, Kirua Vunja, 28.ix.1952 (*Guichard*) (BMNH); 2 ♀, W. Kilimanjaro, Msituni, defoliating *Pinus patula*, 10.xii.1975 (BMNH); 1 ♀, W. Kilimanjaro, Moshi, on *Pinus patula* (BMNH); 23 ♂, 5 ♀, nymphs, Kilimanjaro, S. side nr Manderu hut, 2370–2730 m, 15.xi.1964 (*Jago*) (BMNH); 30 ♂, 29 ♀, E. of Mt Meru, Ngurdota-Meru N.P., crater lake rim, forest glades, 22.xi.1964 (BMNH); 5 ♂, 1 ♀, Ngurdota-Meru N.P., Kisari L., 22.xi.1964 (*Jago*) (BMNH); 3 ♂, 3 ♀, Mt Meru, 1426 m, 25.ii.1967 (*E. S. Brown*) (COPR, London); 5 ♂, 7 ♀, Jekukumia R., 3°14'S, 36°47'E, 2.vi.1972 (*Robertson & Robertson*) (COPR, London).

**DISCUSSION.** The genus is monotypic. The new generic name refers to the preference this species has for montane forest and lower heath zones on Kilimanjaro and Meru mountains.

The unusual pronotal morphology of this species is reflected in a less extreme manner in other female Lentulidae, e.g. *Usambilla emaliensis*, which also have an elevated crest in the pronotal metazona. Live material of *A. modicicrus* is interesting since its mating display shows a possible behavioural function for the dorsal humps. Males approach females, the female responding by jerking and opening the hind legs sideways, while pedalling the hind tibiae which are folded and unfolded alternately. The males often orientate incorrectly head to tail, the female responding by more violent jerking or kicking. If, however, the male approaches correctly from behind he climbs the female abdomen and nibbles at the female tergites after the fashion of some female cockroaches. In *A. modicicrus* the male climbs forward until he nibbles the pronotal bulge, whereupon the female presents her abdominal tip for copulation. A similar function may be involved in the strange bilateral pits on the metazona of many flightless Catantopinae, e.g. *Aresceutica* and *Serpusia* species.

Its attack on *Pinus patula* was preceded by years in which this grasshopper was very abundant in the indigenous natural vegetation. At the higher habitats *A. modicicrus* lives in a zone prone to unstable weather conditions with irregular rainfall. It is possible that drought conditions, forcing the insect to sample exotic *Pinus*, were responsible for the initial phase of the adaptation that insects have shown to a new food plant. Forestry involving *Pinus patula* should be free of attack by this species if trees are planted in areas other than Meru and Kilimanjaro. The very similar *Rhainopomma montanum* found in the West Usambara and Pare mountains is unlikely to adapt to *Pinus* species. Care should be taken not to introduce *A. modicicrus* to other highland areas of East Africa. This could be easily done if young trees were transferred with egg pods hidden in soil at their roots.

***RHAINOPOMMA* gen. n.**

(Figs 41–72)

Type-species: *Adolfia usambarica* Ramme.

**DIFFERENTIAL DIAGNOSIS.** *Male.* Differing from all other Lentulidae and particularly the closely similar genus *Usambilla* in the extreme apical position of the aedeagal barbs (Figs 63, 64). Otherwise form of supra-anal plate (Figs 50–54) and epiphallus as in *Usambilla* (compare Figs 65, 144). Inter-ocular space very narrow, a feature correlated with great inflation of the compound eyes (Figs 41–45).

*Female.* Vertex narrower in proportion between compound eyes than in females of *Usambilla* (compare Figs 49, 83), but this apart identical with that genus.

*Coloration.* Male more brightly coloured than the female. Hind tibiae blue in some species, a character so far known from only one *Usambilla* species.

**DISCUSSION.** Distribution of the genus suggests a long period of evolution in wet lowland to middle altitude montane forests in eastern Africa, east of the Rift Valley. Habitats generally in higher rainfall areas than those of *Usambilla*. Females only surely identified generically by association with the males.

The genus is distributed in SE. Kenya and the piedmont forest blocks of the Pare, Usambara, Nguru, Uluguru mountains and Pugu hills. It is thus indigenous to forests on ancient uplifted mountain blocks which have not experienced the volcanism characteristic of the central rift. Their speciation suggests isolation in forest islets as a major factor in speciation.

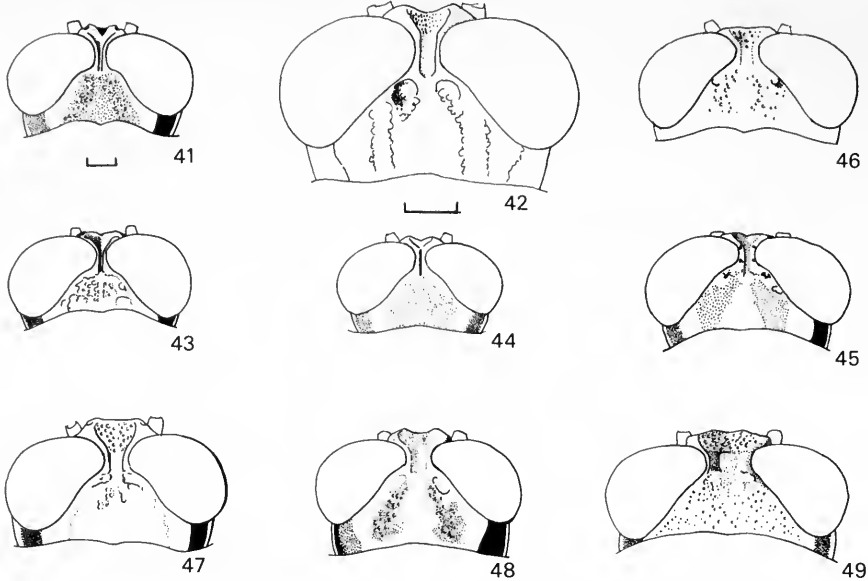

Figs 41–49 *Rhainopomma* species, dorsal aspect of head. 41, *R. usambaricum*, male. 42, *R. montanum*, male. 43, *R. nguruense*, male. 44, *R. wapugu*, male. 45, *R. magnificentum*, male. 46, *R. usambaricum*, female. 47, *R. nguruense*, female. 48, *R. wapugu*, female. 49, *R. magnificentum*, female. All scale lines represent 0.5 mm, that under Fig. 42 applies only to that figure.

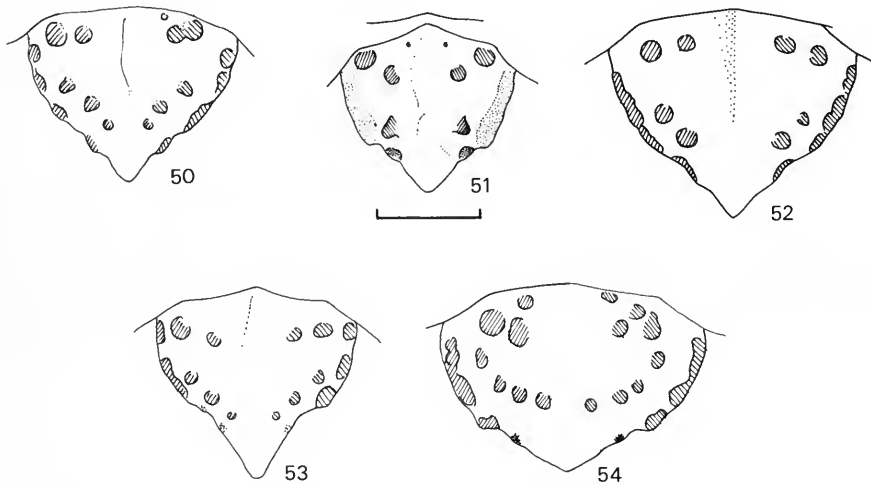

Figs 50–54 *Rhainopomma* species, male supra-anal plate. 50, *R. usambaricum*. 51, *R. montanum*. 52, *R. nguruense*. 53, *R. wapugu*. 54, *R. magnificentum*. Scale line represents 0.5 mm.

### Key to species

#### Males

- |   |   |                                       |
|---|---|---------------------------------------|
| 1 | Knees of posterior femora blue . . . . .  | <i>R. usambaricum</i> (Ramme) (p. 16) |
| – | Knees of posterior femora red-brown . . . . .   | 2                                     |
| 2 | Posterior tibiae sooty brown in apical four-fifths . . . . .  | <i>R. wapugu</i> sp. n. (p. 19)       |
| – | Posterior tibiae uniformly coloured or only with black or brown pigment at extreme tips . . . . .   | 3                                     |
| 3 | Supra-anal plate bearing fewer than 10 black teeth or denticles on disc (Fig. 42). Small insects without clear dorso-lateral light body stripes . . . . . | <i>R. montanum</i> (Kevan) (p. 17)    |
| – | Supra-anal plate with at least 14 black teeth or denticles on disc. Larger insects, usually with clear dorso-lateral body stripes . . . . .               | 4                                     |

- 4 Light body stripes white, upper and lower stripe viewed laterally being clearly delineated above. Smaller insects, body length under 15 mm. Hind tibiae bright blue . . . . . *R. nguruense* sp. n. (p. 17)
- Light body stripes creamy to buff in colour with upper lateral stripe more poorly delineated on its upper margin. Large insects, body length never less than 16 mm. Hind tibiae dull green. . . . . *R. magnificum* sp. n. (p. 20)

**Females**

- 1 Hind tibiae uniform blue, spines black tipped . . . . . 2
- Hind tibiae green with or without blue-black pigment . . . . . 3
- 2 Hind knee lunules (Figs 55, 59) dark slaty blue, blacker above. Hind femur otherwise yellowish. Light dorso-lateral and lateral body stripes golden yellow in colour . . . . . *R. usambaricum* (Ramme) (p. 16)
- Hind knee and lunules (Figs 56, 61) light brown. Hind femur dark olivaceous with dorsal part brown. Light dorso-lateral and lateral side stripes light ochreous brown . . . . . *R. nguruense* sp. n. (p. 19)
- 3 Hind tibiae distally blue-black; proximal quarter green. Pronotum with weak but distinct convex carina dorsally . . . . . *R. wapugu* sp. n. (p. 19)
- Hind tibiae light yellow-green. Pronotum dorsally lacking median carina and decumbent, concave in profile, or lightly convex, especially at rear . . . . . 4
- 4 Hind femur 3.25 times longer than deep. Large insects; body length 18 mm. Upper carina of hind femur convex (Figs 58, 62) . . . . . *R. magnificum* sp. n. (p. 20)
- Hind femur over 4.00 times longer than deep. Smaller insects with body length 15 mm. Upper carina of hind femur almost straight . . . . . *R. montanum* (Kevan) (p. 17)

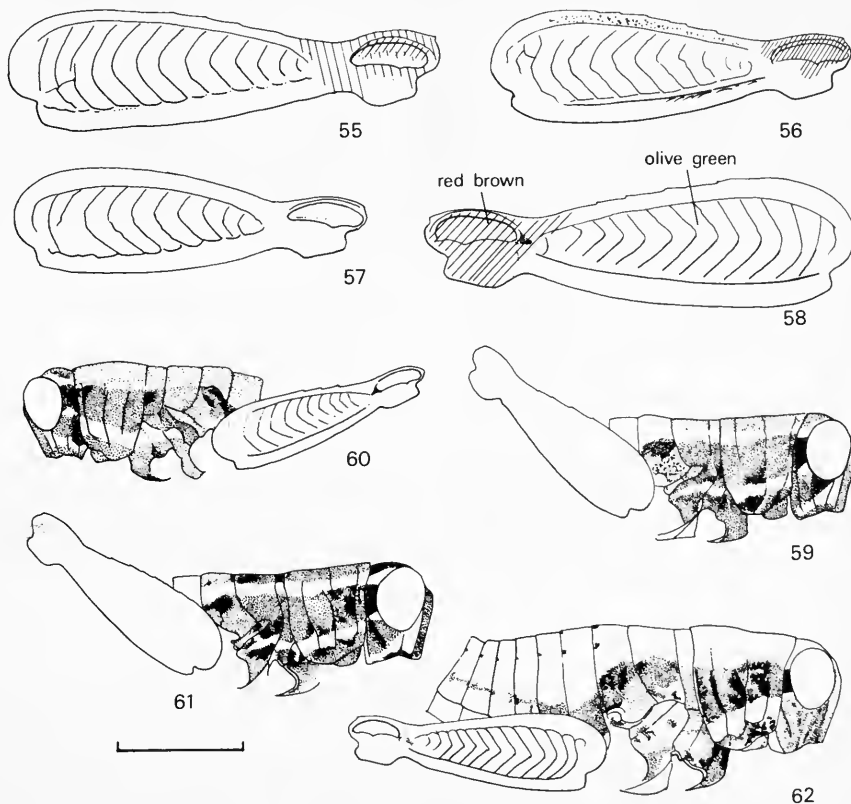

**Figs 55–62** *Rhainopomma* species. 55–58, male posterior femora of (55) *R. usambaricum*; (56) *R. nguruense*; (57) *R. wapugu*; (58) *R. magnificum*. Scale line under Fig. 58 represents 1 mm and applies throughout. 59–62, lateral aspect of female head, thorax and hind femur of (59) *R. usambaricum*; (60) *R. wapugu*; (61) *R. nguruense*; (62) *R. magnificum*. Scale line under Fig. 61 represents 5 mm and applies throughout.

***Rhainopomma usambaricum* (Ramme) comb. n.**

(Figs 41, 46, 50, 55, 59, 63–65)

*Adolfia usambarica* Ramme, 1929: 305, figs 28b, 29b, 30a. Holotype ♂, TANZANIA: Amani, Usambara, iii.1906 (Vosseler) (MNHU, Berlin) [examined].

**DIFFERENTIAL DIAGNOSIS.** *Male.* Antennal segments 1–3 green, 10 and 13 white, rest black. Head (Fig. 41) with dorsal triangular occipital area black, frons and two stripes behind and from ventro-posterior edge of compound eye, dark brown. Vertex, a band round back edge of compound eye and lower half of genae, white. Pronotum dark brown with pair of dorso-lateral and lateral wide white bands, which are yellow in metazone. White pronotal bands continued along abdomen as yellow bands, abdominal sternites and sub-genital plate being yellow. Supra-anal plate (Fig. 50) green, with two pairs of basal and three pairs of submarginal black tubercles. Hind knees (Fig. 55) blue, knee lunules grey, rest of femur yellow-green. Fore and mid-femora yellow to green. Hind tibiae blue; spines white, black-tipped. Aedeagus (Figs 63–65) and epiphallus; aedeagal sheath pear-shaped from posterior aspect (Fig. 64) (like that of *R. nguruense*, *R. montanum* and *R. wapugu*), lateral epiphallic sclerites large in proportion to rest of epiphallus (unlike those of *R. montanum*, Fig. 69), with lower lophal lobe of epiphallus pointed but not hooked (Fig. 65, upper, left).

*Female.* Dark brown markings on head and pronotum as for male (Fig. 59), but equivalent white areas yellow, while median dorsal pronotal carina delineated with yellow. Fastigium of vertex (Fig. 46) black with yellow margins. Dorso-lateral yellow bands on body clearly marked back to at least abdominal tergite 1. Antennal markings similar to male, but black areas dark brown in this sex. All femora green, hind femora yellow on inner side. Hind knees and posterior tibiae dull blue.

**MEASUREMENTS**

	Males	Females
Head width	(13) 3.4–4.0, 3.64	(20) 4.0–5.0, 4.45
Inter-ocular distance	(14) 0.10–0.24,	(20) 0.34–0.49, 0.42
Posterior femur length	(14) 7.6–9.5, 8.37	(20) 9.3–11.0, 10.18
Posterior femur depth	(14) 2.0–2.7, 2.32	(20) 2.5–3.1, 2.85
Total length	(14) 13.4–17.3, 14.90	(20) 17.2–21.0, 18.90

**MATERIAL EXAMINED**

**Tanzania:** 1 ♀, same data as holotype (BMNH); 1 ♀, Amani, iv.1905 (BMNH); 3 ♂, Sigi nr Amani, 460 m, 11.vi.1937 (*E. Burt*) (BMNH); 7 ♂, 1 ♀, same locality but 24.vi.1937 (*E. Burt*) (BMNH); 4 ♂, 4 ♀, same locality but 29.v.1932 (*E. Burt*) (BMNH); 1 ♂, 1 ♀, same locality but 6.vii.1937 (*E. Burt*) (BMNH); 1 ♂, same locality but 4.ii.1937 (*E. Burt*) (BMNH); 3 ♂, 5 ♀, same locality but v.1937 (*E. Burt*) (BMNH); 1 ♂, Kwamtili plant, iii.1952 (*Phipps*) (BMNH); 1 ♂, 2 ♀, Ngomeni, Mlingano for., i.1953 (*Phipps*) (BMNH); 1 ♀, same locality but vii.1952 (*Phipps*) (BMNH); 5 ♂, 6 ♀, 1 nymph, E. Usambara Mts, Sigi nr Amani, [2–11].iv.1964 (*N. D. Jago*) (COPR, London); 1 ♂, 7 ♀, 3 nymphs, same locality, [18–31].xii.1965 (*N. D. Jago*) (BMNH); 1 ♂, 1 ♀ nymph, W. Usambara Mts, Mkusu for. res., 11.xi.1964 (*N. D. Jago*) (BMNH); 2 ♂, 1 ♀, E. Usambara Mts, Kwamkora for. res., 7.iv.1966 (*N. D. Jago*) (BMNH); 2 ♂, 1 ♀, E. Usambara Mts, Amani-Sigi for. res., xii.1966 (*N. D. Jago*) (BMNH); 1 ♂, 1 ♀, E. Usambara Mts, Amani Rest. Ho., 5.iv.1966 (*N. D. Jago*) (BMNH); 4 ♂, 4 ♀, E. Usambara Mts, nr Amani, 9.xi.1964 (*N. D. Jago*) (BMNH). **Kenya:** 1 ♂, 4 ♀, Shimba hills, iii.1941 (*Van Someren*) (BMNH).

**DISCUSSION.** *R. usambaricum* occupies wet lowland forest in the east Usambara mountains and immediately adjacent hills. Its ecological preference is typical for the other members of the genus, which also prefer wet, warm and sunny lowland forest, in contrast to upland habitats. *Chromous-ambilla* parallels it in having brightly coloured males, but differs in occupying degraded montane forest at higher altitudes in the hinterland of east Africa. *R. montanum* (see material studied) penetrates a little higher into the wetter warmer forest areas of the West Usambara massif and converges in appearance on *A. modicrus* to such an extent that for many years the two were confused taxonomically.

***Rhainopomma montanum* (Kevan) comb. n.**

(Figs 42, 51, 68, 69)

*Usambilla montana* Kevan, 1950: 211, fig. 3b. Holotype ♂, KENYA: Teita hills, 1370–1680 m, shrubby bushes and forest clearings, 24.xii.1945 (*Kevan*) (BMNH) [examined].

**DIFFERENTIAL DIAGNOSIS.** *Male.* Much smaller than *R. usambaricum*. Antennae with segments 1–3 green but rest dull brown, segments 8 and 12 being light in colour, cream or green. Head (Fig. 42) dark brown with black markings, at upper end of frons, around antennal sockets, a pair of spots just behind posterior end of groove of fastigium of vertex, a pair of dorso-lateral narrow post-ocular stripes and a broader one laterally behind compound eye, all black. Dorso-lateral light brown band on pronotum very narrow (contrasting with *R. usambaricum*) but lower lateral cream band wide (half depth of dark brown band above it). Rest of thorax and abdomen light brown above narrowly edged with lighter brown; black to dark brown laterally. Abdomen green below; subgenital plate green. Supra-anal plate green with only three pairs of callosities on disc; marginal callosity on each side continuous, unbroken (Fig. 51). Fore and mid-legs dark green; hind femora (like Fig. 58) dark green, knees light brown. Posterior tibiae black at the extreme tip, rest green but light brown adjacent to knee. Spines white with black tips.

*Female.* Small with proportions of inter-ocular space much like those of *R. magnificum* (Fig. 49). Body and head light brown dorsally with only a faint trace of a fine line of lighter colour along each side. Dark brown to black lateral pronotal band similar to that in Fig. 60, but lower lateral light brown to cream band deeper than in *R. wapugu* (half depth of dark band) and upper edge of dark lateral band on segments 1 and 2 of abdomen forming a smooth curve, not angulate. Lateral parts of tergites 1–5 with dark brown or black markings. Hind femora uniformly red-brown, or yellow on inner and lower sides, green on outer area with knee red brown. Hind tibiae green, spines green with black tips; extreme tip of tibiae black, part near to hind knee light brown. Fore and midlegs green or brown.

#### MEASUREMENTS

	Males	Females
Head width	(27) 2.7–3.0, 2.87	(31) 3.3–3.8, 3.80
Inter-ocular distance	(27) 0.18–0.30, 0.22	(31) 0.34–0.63, 0.48
Posterior femur length	(26) 6.1–7.0, 6.40	(31) 7.1–9.7, 8.07
Posterior femur depth	(26) 1.6–2.0, 1.79	(31) 2.1–2.4, 2.22
Total length	(26) 11.1–13.2, 11.74	(29) 13.8–20.3, 15.65

#### MATERIAL EXAMINED

**Kenya:** 4 ♂, 5 ♀, 1 ♀ nymph, Taita hills, vi.1948 (*Van Someren*) (BMNH); 1 ♀, Kenya colony, 1921 (*A. F. J. Gedye*) (BMNH); 26 ♂, 29 ♀, 9 nymphs, Taita farmers' training centre, 8 km S. of Wundonyi, 6.v.1975 (*I. A. D. & A. Robertson*) (COPR, London). **Tanzania:** 6 ♂, 7 ♀, W. Usambara Mts, forest above Mazumbai, 8.vii.1967; 3 ♂, 1 ♀, same locality, nr irrigation canal, 8.vi.1963; 2 ♂, 2 ♀, 1 ♂, 2 ♀ nymphs, W. Usambara Mts, Amboni estate, below Mazumbai, 8.vii.1967; 6 ♂, 2 ♀, Mombo-Same rd, foot of S. Pare Mts, Gonja, wet forest, 13.xi.1964; 3 ♂, 3 ♀, W. Usambara Mts, Mazumbai F. Res., vi.1967; 1 ♂, W. Usambara Mts, nr Bumbuli, Mazumbai, 1.i.1967; 15 ♂, 1 ♀, W. Usambara Mts, Sumamagamba F. Res., 12.xi.1964; 14 ♂, 8 ♀, W. Usambara Mts, Mkusu F. Res., 11.xi.1964; 1 ♂, W. Usambara Mts, Lushoto-Shume rd, 9.7 km from Lushoto, 11.xi.1964; 6 ♂, 4 ♀, W. Usambara Mts, Lushoto, 1670 m, 8.vii.1967; 1 ♂, 3 ♀, W. Usambara Mts, nr Shume, 11.xi.1964; 1 ♀, W. Usambara Mts, Lushoto arboretum, 11.xi.1964; 6 ♂, 8 ♀, W. Usambara Mts, Mazumbai, secondary regrowth in quinine plantation, 8.vii.1963. (All (*Jago*); all in BMNH except last COPR, London.)

**DISCUSSION.** Recorded eating *Commellina* species (*A. and I. A. D. Robertson*, pers. comm.) in its Taita hills habitat in Kenya. Here the partial cultivation of a hill slope at the edge of cultivated land offered a particularly favourable habitat, partly shaded by an *Albizia* species and palms. Like its sister genus *Usambilla* this genus is favoured by the opening up of primary forest and population density may be very high, e.g. 100+/square metre. This may contribute to the attack by *Usambilla* on exotics planted in the course of forestry in such areas.

#### *Rhainopomma nguruense* sp. n.

(Figs 43, 52, 56, 61, 66, 67)

Holotype ♂, **Tanzania:** E. foot Nguru Mts, Mtibwa Forest Reserve, nr Turiani, 7.xi.1964 (*N. D. Jago*) (BMNH).

**DIFFERENTIAL DIAGNOSIS.** *Male.* Segments 1–3 of antennae green; other segments black, except segments 10 and 14 which are white. Colour pattern on head as in *R. usambaricum*, but fastigium between eyes marginally narrower (Fig. 43). Light pronotal stripes white but otherwise pattern as in *R. usambaricum*. Meso- and metathorax dark brown, light body stripes white to pink. Posterior third of abdomen, including sub-genital

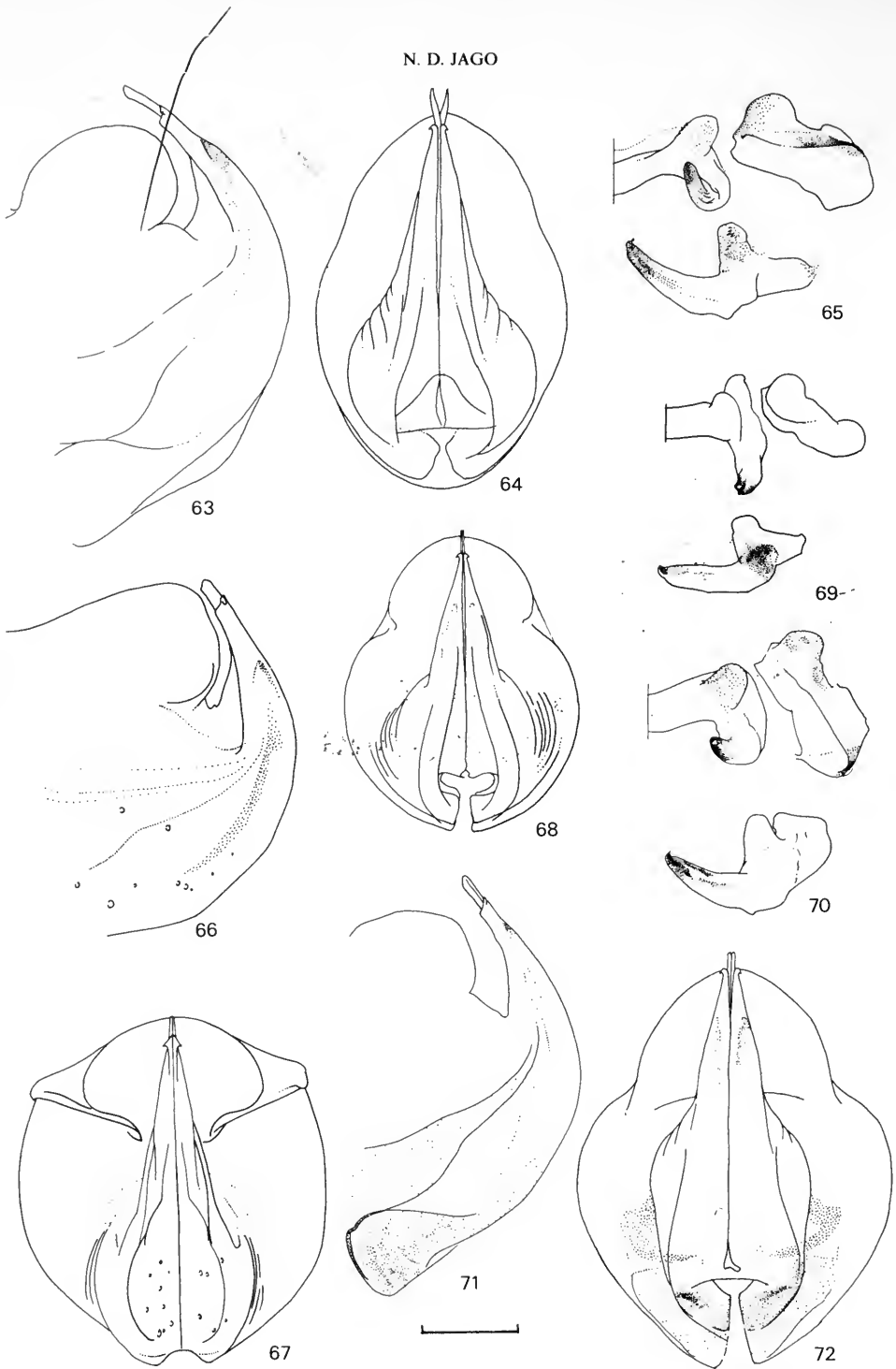

**Figs 63–72** Phallic complex in males of *Rhainopomma* species. 63, left lateral aspect of *R. usambaricum*. 64, posterior apical aspect of *R. usambaricum*. 65, epiphallus of *R. usambaricum*—upper right half and lateral plate, lower from right side. 66, left lateral aspect of *R. nguruense*. 67, posterior apical aspect of *R. nguruense*. 68, posterior apical aspect of *R. montanum*. 69, epiphallus of *R. montanum*—upper right half and lateral plate, lower from right side. 70, epiphallus of *R. magnificum*—upper right half and lateral plate, lower from right side. 71, left lateral aspect of *R. magnificum*. 72, posterior apical aspect of *R. magnificum*. Scale line under Fig. 71 represents 0.5 mm and applies throughout.



plate, pale green. Supra-anal plate (Fig. 52) with two pairs of basal tubercles and two or three pairs on disc (therefore resembling Fig. 53). Posterior femora green with knees red-brown (Fig. 56). Fore and mid-legs entirely green. Posterior tibiae light red-brown near knee and black at extreme tip; rest blue with black tipped white spines. Aedeagal complex (Figs 66, 67) showing aedeagal valves less sharply deflexed forwards than in *R. usambaricum* (Fig. 63) but more elongate than those of *R. montanum* (Fig. 68). Epiphallus like that of *R. usambaricum* (Fig. 65).

*Female.* Body colour and pattern (Fig. 61) like that of *R. usambaricum* but light body stripes white, not yellow. Median dorsal pale line weak or absent. Hind femora yellow to green; knees brown. Posterior tibiae pale blue, brown near knee, brown at extreme tip and with red-tipped white spines.

#### MEASUREMENTS

	Males		Females	
Head width	(23)	3.6–4.5, 3.79	(18)	4.2–4.7, 4.54
Interocular distance	(23)	0.16–0.30, 0.23	(18)	0.46–0.59, 0.53
Posterior femur length	(23)	7.2–8.5, 7.96	(18)	8.5–10.5, 9.86
Posterior femur depth	(23)	2.1–2.6, 2.36	(18)	2.7–3.2, 2.92
Total length	(23)	14.0–15.8, 15.03	(18)	17.1–20.0, 18.71

#### MATERIAL EXAMINED

Paratypes. **Tanzania:** 16 ♂, 10 ♀, 6 nymphs, same data as holotype but [5–7].xi.1964 (BMNH); 1 ♂, same data as holotype (BMNH); 1 ♂, same data but 7.xi.1964; 5 ♂, 5 ♀, 3 nymphs, same data but 5.xi.1964 (COPR, London).

**DISCUSSION.** This species is closely similar to *R. usambaricum* and was probably derived from common stock. Isolation in the adjacent but ecologically isolated forests of the east Usambara and Nguru mountains would explain the divergence between the two species.

### *Rhainopomma wapugu* sp. n.

(Figs 44, 53, 57, 60)

Holotype ♂, **Tanzania:** Pugu hills, SW. of Dar es Salaam, 11.iii.1967 (*N. D. Jago*) (BMNH).

**DIFFERENTIAL DIAGNOSIS.** *Male.* Antennal segments 1–5 cream to light brown; rest dark brown excepting segments 10 and 14 which are white. Interocular space narrowest for genus (Fig. 44). Pattern similar to that of *R. usambaricum* but light areas white to pink, while dark areas are dark red-brown. Fore and mid-legs entirely green. Hind femora (Fig. 57) light green with light brown genicular part. Hind tibiae light brown near knee. Distal three-quarters dark brown, remaining proximal section green. Tip of abdomen pale green. Supra-anal plate (Fig. 53) with two pairs of basal tubercles and three pairs of tubercles on disc; apical tongue rather large, two-fifths length of whole plate when measured on mid-line.

*Female.* Antennal segments 1–3, apical parts of 4, 5 and 6, whole of 9, 11 and 15 white, rest black. Dorso-lateral light body stripes weak, narrow, thus differing from *R. usambaricum* and *R. nguruense*, but resembling *R. montanum*. Dorsal side of head with pair of black triangular marks on either side of dorsal mid-line. Dark brown lateral stripes (Fig. 60) about 3 times deeper than lower light pink side stripe and angulate on tergite 1 of abdomen. Fore and mid-legs green, femora brown dorsally. Hind femora light brown above and internally with large grey spot at base; outer area green; lower outer area yellow; knee entirely red-brown. Colour of hind tibiae as for male.

#### MEASUREMENTS

	Males		Female
	Holotype	Paratype	Paratype
Head width	3.4	3.6	4.37
Interocular distance	0.15	0.17	0.48
Posterior femur length	7.2	7.2	9.54
Posterior femur depth	2.1	2.1	2.77
Total length	13.7	13.4	17.72

#### MATERIAL EXAMINED

Paratypes. **Tanzania:** 1 ♂, 1 ♀, data as holotype (BMNH).

*Rhainopomma magnificentum* sp. n.

(Figs 45, 49, 54, 58, 62, 70–72)

Holotype ♂, **Tanzania**: Mombo-Same rd, foot of S. Pare Mts, Gonja, wet forest, 13.xi.1964 (*N. D. Jago*) (BMNH).

**DIFFERENTIAL DIAGNOSIS.** *Male.* Large species, total length about 17 mm. Antennae green in basal half, darkening to brown distally with light cream tip. Vertex and occiput (Fig. 43) with relatively wide ocular interspace, dark brown dorsally and on frons. Cream area between frons and sub-ocular sulcus; gena dark brown bordered above by very narrow cream stripe from rear of compound eye to back of occiput. Pronotum and body back to tergite 3 of abdomen with dark brown dorsal stripe bordered laterally by bold dull yellow bands equal in width to that on pronotal side lobe (unlike female where lateral pale stripe like that of male but dorsolateral pale band lacking (Fig. 62)). Fore and mid-legs green. Hind femora green with knees light brown (Fig. 58). Hind tibiae light green, light brown at each extremity and with black-tipped green spines. Abdomen, including supra-anal plate, brown above, green below. Sub-genital plate green. Supra-anal plate (Fig. 54) with up to seven pairs of non-marginal tubercles; much wider than long. Base of aedeagus (Figs 71, 72) parallel-sided, not flask-shaped. Epiphallus with well-developed hook on apex of ventral lophi and large anterior projection of upper lophal lobe (Fig. 70).

*Female.* Head and body light brown above. Antennae like those in male. Dark black band behind compound eye bordered with narrow cream stripe ventrally (Fig. 62). Upper margin of dark brown side stripe with distinct up-curved zone at front of pronotal prozona and above side of thoracic tergite III and abdominal tergite I. Black zone extends from abdominal tergite I along side of tergites to back of segment 4. Ovipositor valvulae greenish. Fore and mid-legs green. Hind femora and tibiae as in male, but femora light brown dorsally. Large insects for the group (see measurements).

## MEASUREMENTS

	Males	Females
Head width	(5) 4.1–4.4, 4.28	(3) 5.1, 5.1, 4.4*
Inter-ocular distance	(5) 0.29–0.32, 0.31	(3) 0.79, 0.84, 0.69*
Posterior femur length	(5) 9.0–9.8, 9.28	(3) 11.1, 11.7, 9.4*
Posterior femur depth	(5) 2.6–2.9, 2.74	(3) 3.5, 3.4, 2.8*
Total length	(5) 16.0–18.7, 17.57	(3) 21.8, 21.5, 18.2*

\* Specimen from slightly higher elevation at Soni.

## MATERIAL EXAMINED

Paratypes. **Tanzania**: 3 ♂, 2 ♀, 1 nymph, same data as holotype (1 ♂, 1 ♀, COPR, London; rest BMNH); 1 ♂, data as holotype but 10.vi.1967; 1 ♀, Soni, 17.xi.1950 (*J. Phipps*) (BMNH).

*USAMBILLA* Sjöstedt

*Usambilla* Sjöstedt, 1909: 191. Type-species: *Usambilla olivacea* Sjöstedt, by original designation.

*Adolfia* Rehn, 1914: 147. Type-species: *Adolfia insolita* Rehn, 1914: 148, by original designation. [Homonym of *Adolfia* Guerich, 1909 (Brachiopoda).]

*Rehnula* Uvarov, 1939: 457. [Replacement name for *Adolfia* Rehn.] [Synonymized by Dirsh, 1956: 152.]

**DIFFERENTIAL DIAGNOSIS.** *Male.* Vertex with narrow (Fig. 86) to wide (Fig. 92) inter-ocular sulculus. Frons depressed (Figs 90, 91) with frontal ridge almost flat, hardly elevated. Dorsal pronotal carinula moderately developed to weak or absent. Supra-anal plate, but not ninth abdominal tergite, armed with marginal callosities as well as elevated black nodules on disc (Figs 94–101). Epiphallus simple, lacking true ancorae but with hook-like ventro-lateral lophus (Figs 144, 145, 150, 131, 134, 137, 140) terminating in one, two or four hooks. Penis valves with lateral barbs situated short of apex (Fig. 133).

*Female.* Vertex proportionately wider than male, but with no special generic facies. Ventral ovipositor valves unspecialised (Figs 148, 149), not shovel-shaped as in *Chromousambilla* (Fig. 24).

**DISCUSSION.** The genus is known from predominantly upland areas of eastern Zaire, Ruanda, the forests of Uganda, south-western, central and northern Tanzania and the southern half of Kenya. The species occupy a wide range of ecological niches. Thus *U. haematogramma* lives in the upper Ufipa plateau forest margins, but *U. insolita* and *U. sagonai* in clearings in the wettest tropical forests of Ruanda, Zaire and Uganda. *U. turgidicrus* lives in upland scrub and woodland in

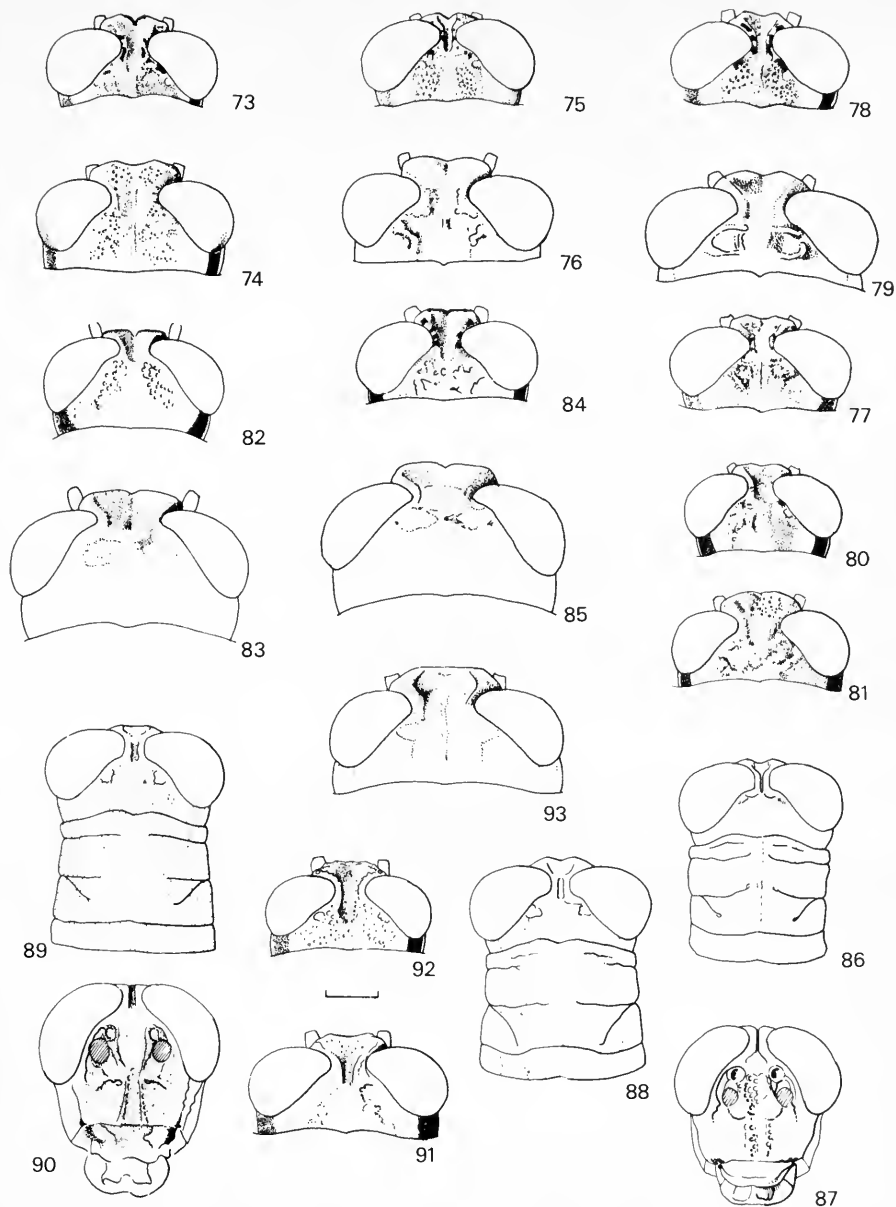

**Figs 73–93** Dorsal or frontal aspect of head of *Usambilla* species. 73, male *U. turgidicus turgidicus*. 74, female, same. 75, male *U. oraria*. 76, female, same. 77, male *U. affinis affinis*, Morogoro. 78, male *U. affinis kikomboensis*, Ilonga. 79, female, same. 80, male *U. emaliensis*. 81, female, same. 82, male *U. chlorophrygana*. 83, female, same. 84, male *U. leptophrygana*. 85, female, same. 86, male *U. insolita* paratype, Kwidschiwi I. 87, same, frontal aspect. 88, male *U. sagonai sagonai*, Rwanda. 89, male *U. sagonai fractolineata*. 90, same, frontal aspect. 91, female, same. 92, male *U. haematogramma*. 93, female, same. Scale line under Fig. 92 represents 1.0 mm and applies throughout.

Kenya and northern Tanzania (*Combretum*, *Commiphora* and *Acacia* or *Juniperus* associations), while *U. leptophrygana* and *U. chlorophrygana* occupy drier warmer woodland at lower altitudes. The ecological diversity is matched by subspecific variation in several species, suggesting active speciation in progress.

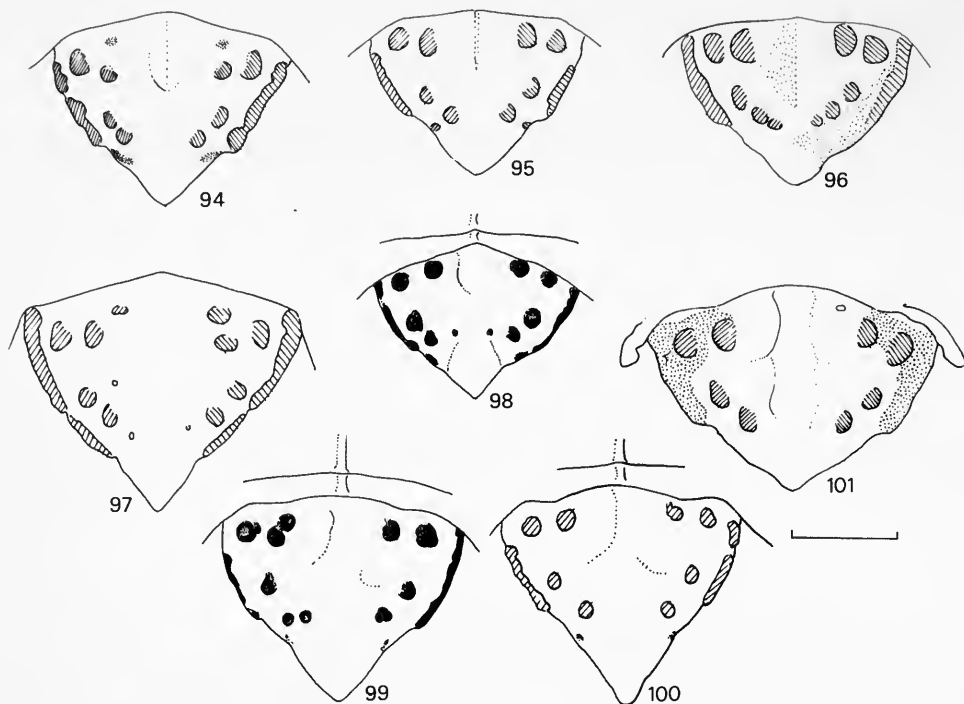

Figs 94–101 Male supra-anal plate of *Usambilla* species. 94, *U. turgidicrus*. 95, *U. oraria*. 96, *U. affinis*. 97, *U. leptophrygana*. 98, *U. insolita*. 99, *U. sagonai sagonai*. 100, *U. sagonai fractolineata*. 101, *U. haematogramma*. Scale line under Fig. 101 represents 0.5 mm and applies throughout.

## Key to species and subspecies

### Males

- 1 Ocular interspace dorsally more than 2.5 times width of first antennal segment (Fig. 92). Lateral black side stripe narrowly edged above with red pigment (as in Fig. 129, ♀). Supra-anal plate (Fig. 101) with broad black area confluent with both basal tubercles on each side. Hind femora light olive green, knee light orange-brown . . . . . *U. haematogramma* sp. n. (p. 36)
- Ocular interspace narrower, almost twice width of basal antennal segment. Never with red stripe delineating upper edge of lateral black stripe. Supra-anal plate with marginal rugosity, but black pigment never confluent with basal tubercles . . . . . 2
- 2 Interocular distance dorsally equal to width of basal antennal segment (Figs 75, 86, 87). Supra-anal plate with no more than a pair of basal tubercles on each side (Figs 95, 98) . . . . . 3
- Interocular distance at least 1.5 times width of basal antennal segment. Supra-anal plate with two pairs of basal tubercles (Figs 96, 99, 100, 152) or up to three basal tubercles on each side (Figs 94, 97, 99) . . . . . 4
- 3 Hind femur (Fig. 116) more than 3 times longer than deep. (Rwanda and Zaire (?)) . . . . . *U. insolita* (Rehn) (p. 34)
- Hind femur (Fig. 108) very stocky and thickened from side to side, length to depth ratio about 2.6. Subgenital plate very short (Fig. 95) and folding under parameres which are received into impressions on its upper surface. Subgenital plate protrudes beyond supra-anal plate by about length of that plate as seen from above (in *U. insolita* projecting by roughly twice length of supra-anal plate). (Coastal Kenya and NE. Tanzania) . . . . . *U. oraria* sp. n. (p. 32)
- 4 Dorso-lateral and light lateral body stripes (Figs 102, 103) bright yellow in life. Hind tibiae blue. Fore and mid-femora conspicuously hairy above and below. Frons declivate, hardly protruding as seen from above (Figs 88, 89). Median pronotal carinae absent or feeble . . . . . 5
- Dorso-lateral light body stripes; if present, dull grey, light brown but never bright yellow. Hind tibiae yellowish or greenish, with or without black pigment distally and ventrad. Frons declivate or decidedly protruding (Figs 73, 82). Fore and mid femora almost without hairs above. Median pronotal carina weakly to strongly developed (Fig. 105) . . . . . 6

- 5 Yellow genal stripe continuous to back of occiput . . . . . *U. sagonai sagonai* (Ramme) (p. 35)
- Yellow genal stripe interrupted between back of gena and occiput. (Figs 102, 103) . . . . . *U. sagonai fractolineata* subsp. n. (p. 36)
- 6 Hind femora bearing conspicuous black markings (Fig. 115) and of a uniform light brown colour. Frons protruding (Fig. 84) and incised as seen from above. Fastigium of vertex concave anteriorly. Posterior tibiae sooty below and towards tip . . . . . *U. leptophrygana* sp. n. (p. 34)
- Hind femora immaculate or with light markings dorsally at base (Fig. 107), or with a light pregenicular spot (Figs 109, 110). Frons declivate, protruding or decumbent. Fastigium of vertex deeply to shallowly concave anteriorly. . . . . 7
- 7 Lateral dark brown side stripe intense, angularly bent in outline dorso-anteriorly on pronotum (Fig. 106). Frons in profile and from above (Fig. 73) seen to be very produced at its upper end, forming two tubercles which form margins of deeply incised fastigium of vertex. Hind femora light brown with or without darker mottling. Median dorsal pronotal carinula and its continuation on tergites of abdomen weak to strong. Posterior tibiae sooty below and towards tip . . . . . 8
- Lateral dark brown side stripe with smooth upper outline (Fig. 104). Frons in profile and from above protruding (Figs 77, 78, 82) to strongly declivate and downwardly sloped (Fig. 90). Hind femora tending to be green with knee orange-brown. Median dorsal carinula of pronotum weak (Figs 104, 105) to absent. Posterior tibiae unicolorous without black colour below . . . . . 9
- 8 Hind femur very short and plump, length to depth about 3.0. (Vicinity of W. Usambara Mts) . . . . . *U. turgidicus olivacea* Sjöstedt (p. 27)
- Hind femur less robust, length to depth ratio 3.3–3.4 . . . . . *U. turgidicus turgidicus* (Karsch) (p. 25)
- 9 Larger insects, body length just over 15 mm. Length to depth of hind femur (Fig. 113) about 3.40–3.50 . . . . . *U. chlorophrygana* sp. n. (p. 32)
- Smaller insects, body length just under 13 mm at most. Frons only weakly incised as seen from above (Figs 77, 78, 80). Femur length to depth ratio 3.32–3.66 . . . . . 10
- 10 Pronotum lacking median dorsal carinula except for metazonal tubercle . . . . . 11
- Pronotum with clear median dorsal carinula (Fig. 105) in prozona and metazona. Hind femur slender (Fig. 112) with outer area green and rest tending to be brownish . . . . . *U. emaliensis* sp. n. (p. 30)
- 11 Length to depth ratio of hind femur 3.3–3.4 . . . . . *U. affinis affinis* Kevan & Knipper (p. 29)
- Length to depth ratio of hind femur about 3.6 . . . . . *U. affinis kikomboensis* subsp. n. (p. 30)

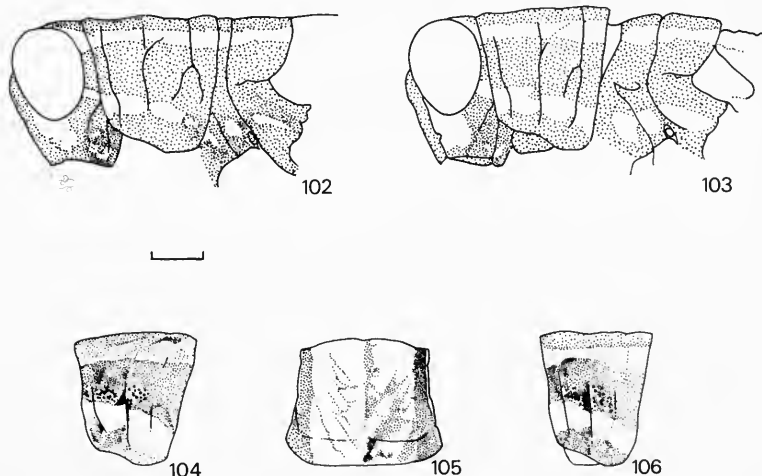

**Figs 102–106** Lateral or dorsal aspect head and/or pronotum of male *Usambilla* species. 102, *U. sagonai fractolineata*, Uganda, Mpanga (darker form). 103, same, Uganda, Mpanga (lighter form). 104, *U. emaliensis*. 105, same, from above. 106, *U. turgidicus turgidicus*. Scale line under Fig. 102 represents 1 mm and applies throughout.

**Females**

Females of *U. insolita* were not available for study; females of *U. affinis affinis* and *U. affinis kikomboensis* cannot be differentiated.

- 1 Lateral black side stripe bordered above with crimson (Fig. 129). Fastigium of vertex very broad and lightly indented . . . . . *U. haematogramma* sp. n. (p. 36)
- Lateral black side stripe, if present, never bordered above with red. Fastigium of vertex much narrower and more deeply incised . . . . . 2
- 2 Hind tibiae blue. (Colour very variable. No difference between races.) . . . . . *U. sagonai* (Ramme) (p. 35)
- Hind tibiae light brown, greenish brown, green or ochraceous . . . . . 3
- 3 Interocular space dorsally 4 times width of basal antennal segment (Figs 76, 79, 81) . . . . . 4
- Interocular space dorsally 5 times width of basal antennal segment (Figs 74, 83, 85) . . . . . 6
- 4 Pronotal median carina dorsally very pronounced (Fig. 125), hind femora very slender, length to depth ratio about 3.6 . . . . . *U. emaliensis* sp. n. (p. 30)
- Median pronotal carina weak. Hind femur much more robust, length to depth ratio 3.0-3.2 . . . . . 5
- 5 Profile of pronotal carina and thorax curved (Fig. 121). Dark lateral side stripe with upper edge markedly bent in prozona. Hind femur length to depth ratio around 3.0. Hind tibiae completely black ventrally in mature (?) specimens, yellowish-ochraceous dorsally . . . . . *U. oruria* sp. n. (p. 32)
- Profile of pronotal carina flatter (Figs. 122, 123, 124). Lateral side stripe, if developed, with anterior upper border almost straight. Length to depth ratio of hind femur about 3.2. Hind tibiae uniformly yellowish . . . . . *U. affinis* Kevan & Knipper (p. 28)
- 6 Frons markedly produced in profile (Figs 119, 120). Pronotal carina moderately strong, whole disc tectiform . . . . . 7
- Frons less strongly produced in profile (Figs 126, 127). Median pronotal carina almost undeveloped, disc depressed . . . . . 8
- 7 Hind femur more robust, length to depth ratio roughly 3.0 or less. Pronotum wrinkled and punctate above (Fig. 120) . . . . . *U. turgidicus olivacea* Sjöstedt (p. 27)
- Hind femur more slender, length to depth ratio about 3.2. Pronotum not wrinkled, finely punctate (Fig. 119). . . . . *U. turgidicus turgidicus* Karsch (p. 25)
- 8 Large insects, body length more than 20 mm. Probably lack lateral body stripe. Posterior femora dull olivaceous with knee light brown (Figs 83, 126) . . . . . *U. chlorophrygana* sp. n. (p. 33)
- Smaller rugose insects, body length about 18 mm. Lateral side stripes weak except on first abdominal tergite and latero-anterior part of pronotum (Fig. 127). Posterior femora brown with darker mottling . . . . . *U. leptophrygana* sp. n. (p. 34)

***Usambilla turgidicus* (Karsch)**

(Figs 73, 74, 94, 106, 107, 119, 120, 131-133)

*Lentula turgidicus* Karsch, 1896: 280.

**DIFFERENTIAL DIAGNOSIS.** *Male.* Head with deeply grooved fastigium of vertex forming a notch at its point of contact with upper end of frons (Fig. 73). Head transversely angulate at level of back end of median fastigial sulculus, occiput being wrinkled and pitted. Sides of vertex in front of eyes and area of ocellus on each side protruding. Pronotum lightly tectiform on disc with low median carinula. Upper edge of dark lateral pronotal side stripe showing sharp angular change of direction between sulculi one and two. Dorsolateral light brown to creamy stripes extending to tergite 8. Sides of tergites 1-6 of abdomen shiny black. Supra-anal plate (Fig. 94) with four pairs of strong black nodules on disc, two weaker ones at base. Epiphallial lophus with four teeth (Fig. 131). Penis valves (Figs 132, 133) directed forwards at about 45° to long axis of body.

Fore and midlegs light olive brown. Hind femora speckled blackish dorso-anteriorly (Fig. 107), with or without black comma in front of knee lunule. Hind tibiae light olive brown, spines black-tipped. Hind tibiae sooty black or darker brown ventrally in apical two-thirds or half. Lateral dark stripe on pronotal side lobe extended boldly along side of meso- and metathorax.

*Female.* Stocky (Fig. 119) with vertex and frontal ridge which meet in a raised protruding shelf in front of compound eyes. Pronotum lightly tectiform above, with a lateral dark side stripe with an angular upper profile in front of second sulculus and fading abruptly behind (Fig. 119). Lateral band on thoracic segments obscure; dark band intensified on abdominal segments 1-6, black and shiny on segments 2-6. Black area on side of abdominal segment 1 variable in size.

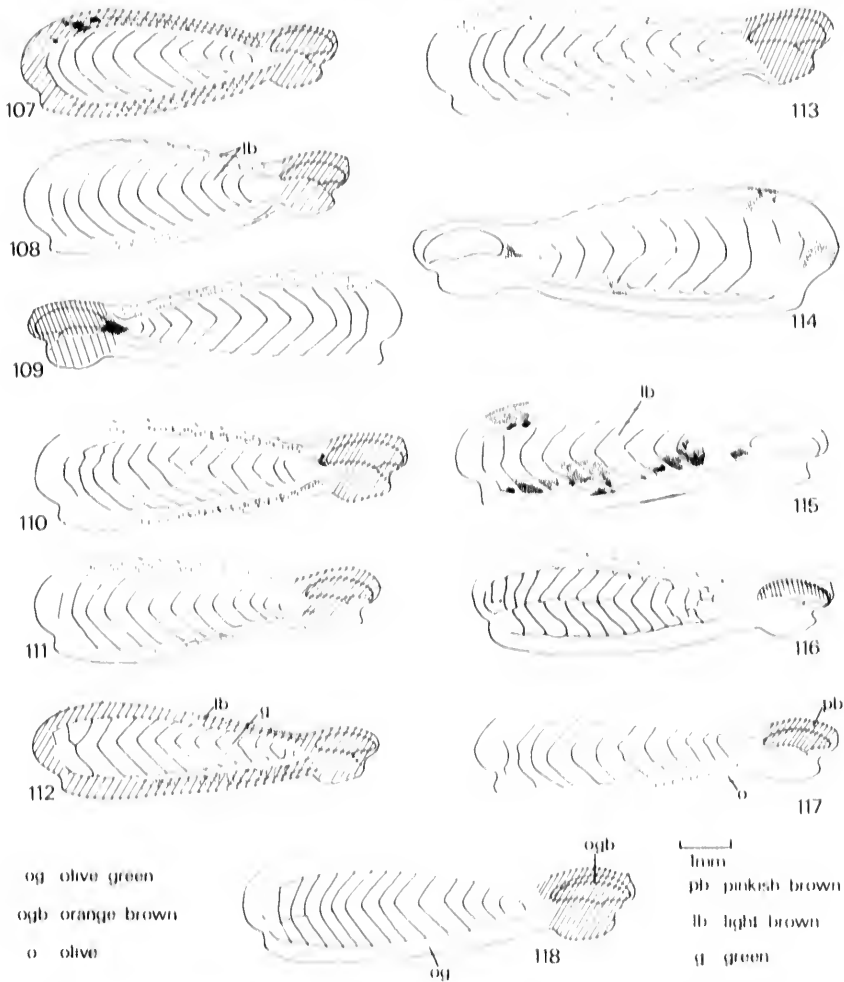

**Figs 107–118** Posterior femora of male *Usambilla* species. 107, *U. turgidicus olivacea*, L/D 3.00, Mombo. 108, *U. oraria*, L/D 2.97, Mombasa. 109, *U. affinis kikomboensis*, L/D 3.6, Kikombo. 110, same, L/D 3.36, Ilonga. 111, *U. affinis affinis*, L/D 3.28, Uluguru Mts. 112, *U. emaliensis*, L/D 3.66, Emali range. 113, *U. chlorophrygana*, L/D 3.46, Kikombo, Mpwapwa. 114, *U. chlorophrygana*, dark form, L/D 3.26, 10 mls N. of Ussure. 115, *U. leptophrygana*, L/D 3.32. 116, *U. insolita* L/D 3.45. 117, *U. sagonai fractolineata*, L/D 3.47. 118, *U. haematogramma*, L/D 3.55, Ulipa. Scale line under Fig. 112 represents 1 mm and applies throughout.

Ventral valves of ovipositor simple, pointed. General colour grey to rugose dark brown with black to blackish pronotal side stripe, bordered below by short curved grey stripe, separated from ventral margin of side lobe by a band of dark brown or grey of roughly same depth.

***Usambilla turgidicus turgidicus* (Karsch)**

(Figs 73, 74, 94, 106, 119, 131–133)

*Lentula turgidicus* Karsch, 1896: 280. Holotype ♂, KENYA: Kitui (MNHU, Berlin) [examined].

**DIFFERENTIAL DIAGNOSIS.** Male hind femora less robust than in subsp. *olivacea*, length to depth ratio 3.3–3.4. Female similarly more elongate with slimmer femora, above ratio 3.2. Pronotum not wrinkled, finely punctate (Fig. 119).

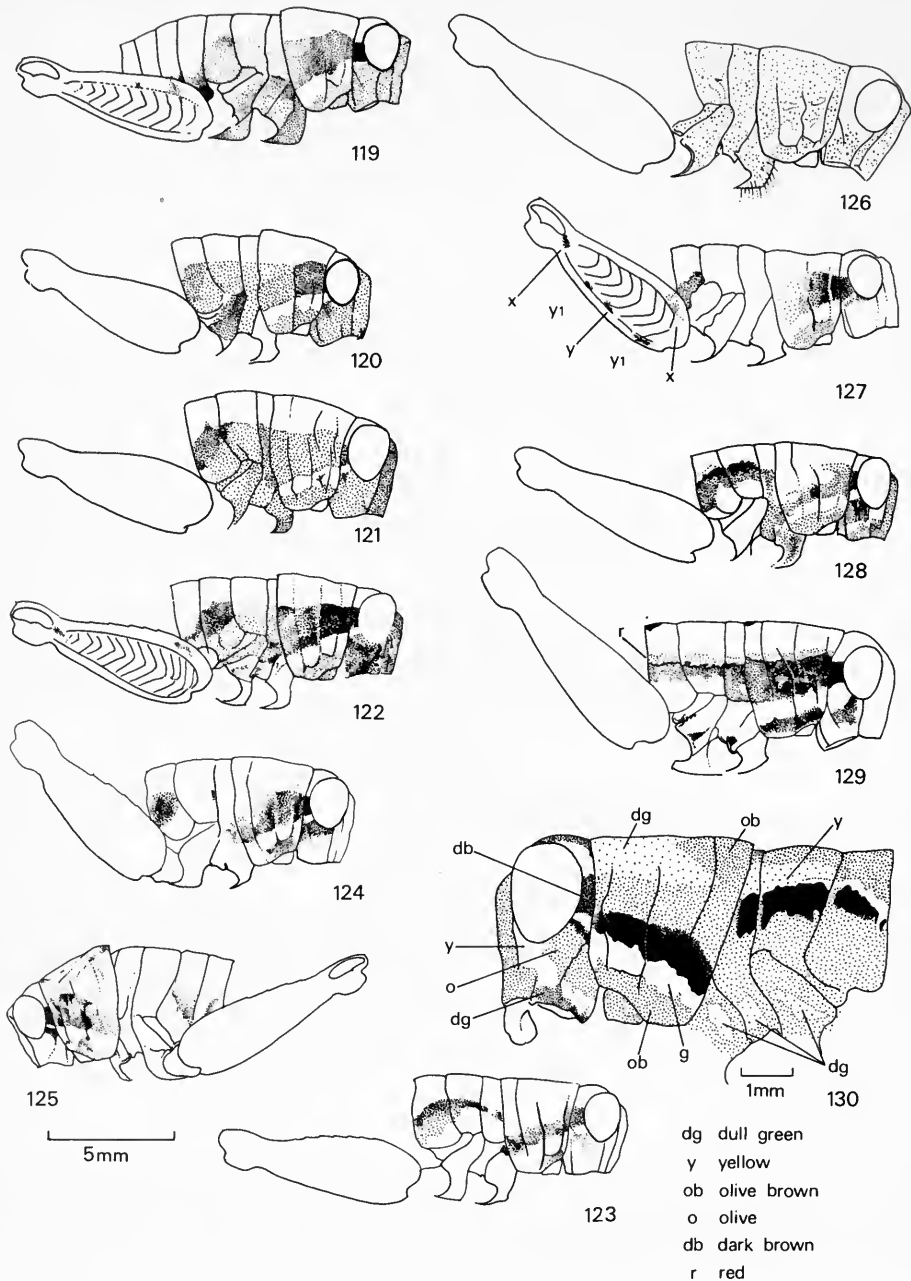

**Figs 119–130** Lateral aspect of head, thorax and posterior femur of female *Usambilla* species. 119, *U. t. turgidicus* (S2794). 120, *U. t. olivacea*, W. Usambara. 121, *U. oraria*, Kenya, Rabai. 122, *U. affinis kikomboensis*, Ilonga. 123, same, lighter form. 124, same, intermediate form. 125, *U. emaliensis*. 126, *U. chlorophrygana*. 127, *U. leptophrygana*. 128, *U. sagonai fractolineata*. 129, *U. haematogramma*. 130, *U. sagonai sagonai*. Scale line under Fig. 125 represents 5 mm and applies to Figs 119–129. Scale line under Fig. 130 represents 1 mm and applies to that figure.



## MEASUREMENTS

	Males	Females
Head width	(17) 2.9–3.5, 3.37	(29) 3.7–4.2, 4.01
Posterior femur length	(17) 6.3–7.9, 7.23	(28) 7.4–9.4, 8.50
Posterior femur depth	(17) 1.8–2.4, 2.20	(28) 2.5–3.0, 2.68
Body length	(16) 12.3–15.0, 13.75	(27) 14.8–18.1, 16.69

## MATERIAL EXAMINED

**Kenya:** 1 ♀, Mtunguni hill nr Tulia, Kitui distr., 150 m, 01°12'S, 38°02'E, hillside with *Combretum*, *Commiphora* and *Acacia* woodland, 28.iv.1975 (*Robertson & Robertson*) (COPR, London); 1 ♂, 1 ♀, nr Kibwezi, 5 km SE. of Mbuinzau, 02°24'S, 37°55'E, 940 m, lichens and spiny vegetation on recent lava, 5.v.1975 (*Robertson & Robertson*); 1 ♂, 1 ♀, 5 km N. of Mwatate, Wundangi rd, 03°27'S, 38°22'E, 910 m, fairly dense scrub woodland, 6.v.1975 (*Robertson & Robertson*) (COPR, London); 15 ♂, 25 ♀, Mtunguni hill, 01°12'S, 38°02'E to 01°13'S, 38°02'E, nr Tulia, Kitui distr., 910 m, heavy juniper woodland and plantations, 10.v.1975 (*Robertson & Robertson*) (5 ♂, 4 ♀, BMNH; rest COPR, London); 1 ♀, Athi R. crossing, 25.6 km NNE. of Kibwezi, 430 m, 22.vii.1934 (*Vanderbilt Exped. Kenya Africa, Rehn*) (BMNH); 1 ♂, 1 ♀, S. Pare Mts, hillside above Gonja, c. 1000 m, [12–16] vi.1974 (*Hollis*) (BMNH).

**DISCUSSION.** More material of the nominate subspecies is required before the true junction between the subspecies can be determined.

*Usambilla turgidicrus olivacea* (Sjöstedt) stat. n.

(Figs 107, 120)

*Usambilla olivacea* Sjöstedt, 1909: 186, 192. Holotype ♀, TANZANIA: Usambara, Mombo, vi. (*Sjöstedt*) (NR, Stockholm) [examined].

**DIFFERENTIAL DIAGNOSIS.** Male with hind femur length to depth ratio 3. Female with hind femur length to depth ratio 3 or less. Pronotum wrinkled and punctate above (Fig. 120). Subspecies markedly more stocky than nominate race. Male genitalia identical.

## MEASUREMENTS

	Male		Females	
			Holotype	
Head width	3.19	4.3	(4.8)	4.20
Posterior femur length	6.66	3.7	(4.0)	8.68
Posterior femur depth	2.25	9.3	(10.0)	2.90
Body length	12.31	14.7	(17.0)	16.15

The female holotype measurements in parentheses are those published by Sjöstedt.

## MATERIAL EXAMINED

**Tanzania:** 1 ♂, 1 ♀, Mombo, 9.vii.1967 (*Jago*) (BMNH).

**DISCUSSION.** The dimensions of the holotype published by Sjöstedt do not tally with the accurate modern ones. It is possible that his optical technique gave consistent overestimates. The holotype is thus a smaller insect than published measurements would indicate. *U. turgidicrus olivacea* represents the southernmost outliers of the nominate race.

In life the specimens from Mombo had a light silvery side stripe, the female being light grey in colour. Both have darkened considerably and are now brown.

*Usambilla affinis* Kevan & Knipper

(Figs 77–79, 96, 109–111, 122–124, 134–136)

*Usambilla affinis* Kevan & Knipper, 1961: 372.

**DIFFERENTIAL DIAGNOSIS.** *Male.* Fastigium of vertex (Figs 77, 78) with margins diverging forward, lightly emarginate in front and with deeply to lightly impressed interocular groove (lightest in subsp. *affinis* to deepest in subsp. *kikomboensis*). Front end of fastigium pitted and sculptured. Frontal ridge and whole of

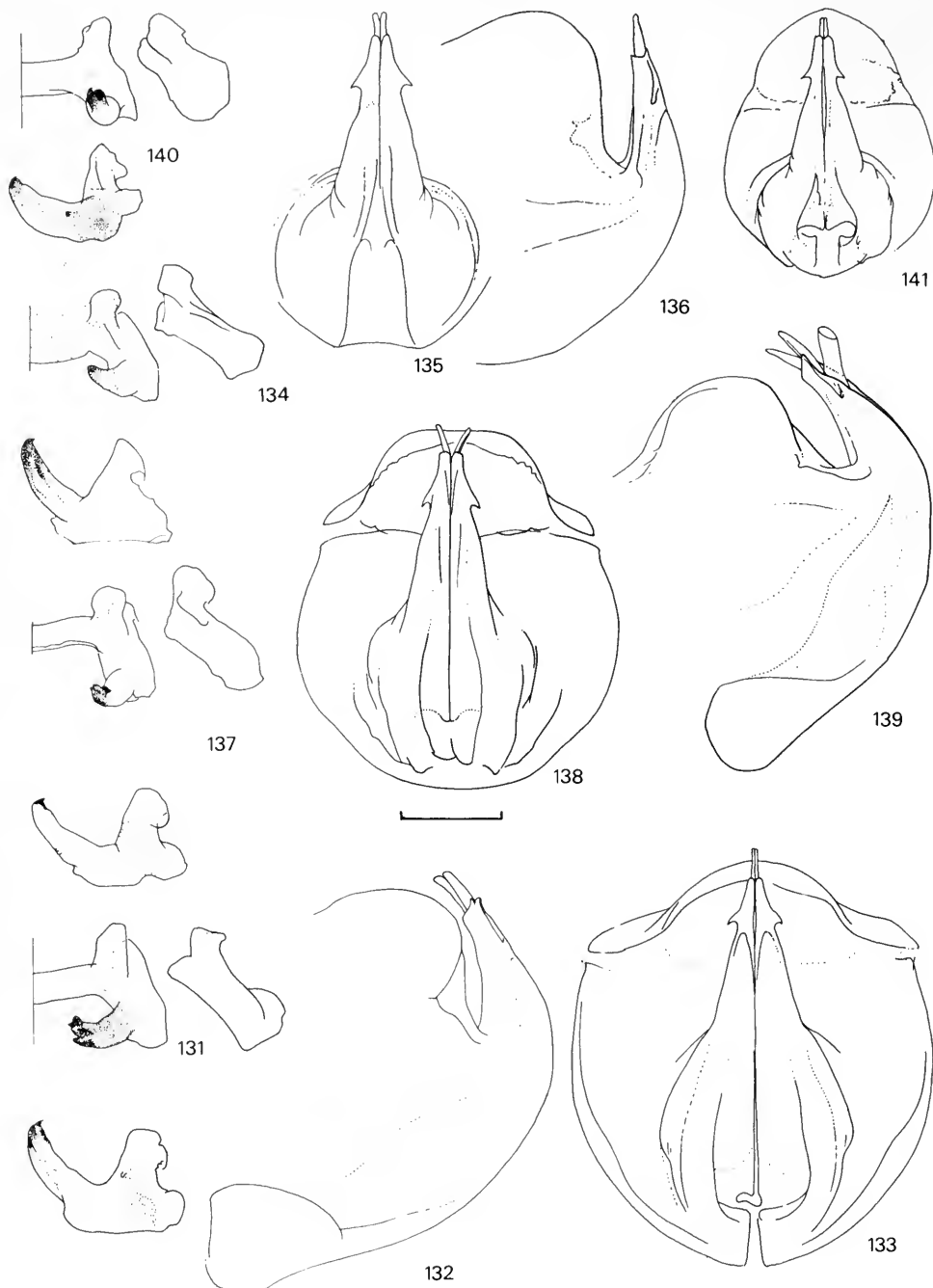

**Figs 131–141** Phallic complex of male *Usambilla* species. 131, epiphallus of *U. turgidicrus turgidicrus*—upper right half and lateral plate, lower from right side. 132, same, aedeagus, left lateral aspect. 133, same, posterior apical aspect. 134, epiphallus of *U. affinis affinis* (Uluguru Mts)—upper right half and lateral plate, lower from right side. 135, same, aedeagus, posterior apical aspect. 136, same, left lateral aspect. 137, epiphallus of *U. emaliensis* (Emali range)—upper right half and lateral plate, lower from right side. 138, same, aedeagus, posterior apical aspect. 139, same, left lateral aspect with spermatophore in situ. 140, epiphallus of *U. oraria*—upper right half and lateral plate, lower from right side. 141, same, aedeagus, posterior apical aspect. Scale line under Fig. 138 represents 0.5 mm and applies throughout.

frons evenly punctate and more protruding than *U. oraria*, but less so than in *U. turgidicus*. Pronotum hardly to weakly tectiform above with pronotal carina absent to moderate. Abdominal tergites lightly carinated dorsally. Supra-anal plate with marginal callosities (Fig. 96) and four to five pairs of tubercles, two or three pairs being distal. Penis sheath and valves apically vertical (Fig. 136). Epiphallus with lophal process ending in a simple hook (Fig. 134). Ancorae absent.

*Female.* Fastigium of vertex sloping forwards in a smooth convexity to meet upper part of frontal ridge (Figs 79, 122, 123, 124). Pronotum and abdominal tergites quite sharply carinate dorsally. Tips of ventral ovipositor valves triangular, pointed.

Coloration of male and female more divergent in the closely allied *U. emaliensis* than in *U. affinis*. Male in general with yellowish to creamy markings at border of compound eye dorsally, on front of fastigium of vertex, below compound eye straddling fronto-genal suture. Lateral dark brown stripe variable in intensity, usually extending weakly onto side of abdomen. Light side stripes pale yellowish to creamy white, lowermost band separated from ventral margin of pronotal side lobe by darker pigment (Fig. 104) and extending across epimera and episterna of thoracic segments 2 and 3 as a whitish band. Fore and mid legs light olivaceous green. Hind femora green with ginger-brown knees (Figs 109–111). Very faint brown comma-shaped marking in front of genicular lunule. Female light brown above with darker median dorsal area, side stripe dark brown (but variable, see Figs 122, 123, 124). Hind femora light olivaceous green with dorso-basal brownish spot and weak sigmoid mark in front of outer and inner knee lunule. Knees light ginger-brown. Hind tibiae, as in male, light yellow-green with spines black-tipped.

*Note.* In both male and female upper profile of lateral dark pronotal side stripe forms a smooth convex curve (Fig. 124) unlike that in *U. turgidicus* (Fig. 119).

**DISCUSSION.** This species forms a north-south cline in which the southernmost populations have short stumpy hind femora (subsp. *affinis*), the northernmost having slender hind femora. Separating the components of the cline is difficult, though zoogeographically the nominate subspecies probably occurs in the Uluguru Mts and southwards, while subsp. *kikomboensis* probably occurs in scattered pockets from Ilonga through Kikombo to the west Usambaras.

### *Usambilla affinis affinis* Kevan & Knipper

(Figs 77, 96, 111, 134–136)

*Usambilla affinis* Kevan & Knipper, 1961: 372, fig. 3, pl. 3, ff. 3–7. Holotype ♂, TANZANIA: Morogoro, Morningside, 31.vii.1954 (*Phipps*) (BMNH) [examined].

**DIFFERENTIAL DIAGNOSIS.** *Male.* Main difference in proportions of hind femur, its length to depth ratio at 3.3–3.4 being less than in subsp. *kikomboensis*. Males tend to have dark dorso-lateral body lines brown. Penis sheath and aedeagus erect, set at right-angles to long axis of body (Figs 135, 136).

Females cannot be differentiated from other subspecies.

#### MEASUREMENTS

	Males	Females
Head width	(3) 3.45, 3.38, 3.74	(3) 4.18, 4.08, 4.48
Posterior femur length	(3) 7.24, 6.99, 7.48	(3) 9.14, 8.30, 9.10
Posterior femur depth	(3) 2.21, 2.89, 3.12	(3) 3.00, 2.65, 2.95
Body length	(3) 12.3, 12.93, 14.79	(3) 16.5, 17.22, 17.24

#### MATERIAL EXAMINED

**Tanzania:** 1 ♀, Morogoro, 1954 (*Phipps*) (paratype of *Usambilla affinis* Kevan & Knipper) (BMNH); 1 ♂, Morogoro, 1320 m, 24.xi.1939 (*E. Burt*) (BMNH); 1 ♂, 1 ♀, Morogoro, xi.1939 (*E. Burt*) (BMNH); 2 ♂, Morogoro, 8.iii.1955 (*Phipps*) (BMNH); 1 ♀, Morogoro, 4.xii.1939 (*E. Burt*); 1 ♂, Uluguru Mts, W. side, 1.6 km S. of Mgeta, 25.x.1964 (*Jago*) (COPR, London); 1 nymph, Uluguru Mts, W. side, Bunduki For. Res., fishing camp, [20–23].x.1964 (*Jago*) (COPR, London).

**DISCUSSION.** The habitats of this subspecies in the Uluguru Mts are characterised by abundant tree ferns and tree lilies, relatively high rainfall and abundant sunshine.

*Usambilla affinis kikomboensis* subsp. n.

(Figs 78, 79, 109, 110, 122–124)

Holotype ♂, Tanzania: Ilonga, 16.vi.1967 (Jago) (BMNH).

**DIFFERENTIAL DIAGNOSIS.** *Male.* Hind femora length to depth ratio about 3.6. More brightly marked than nominate subspecies, with dark brown stripes in that subspecies replaced by black and light body stripes golden yellow. Penis sheath and aedeagal valves directed vertically (as in Fig. 136).

*Female.* Pigmentation variable (Figs 122–124). Frons sloping upwards with a gentle angular change into fastigium of vertex. Face dark brown with black and cream spots or patches. Dark side stripe, when fully developed (Fig. 122), with a gently sinuous upper margin (may be reduced to a dark oblique bar, Fig. 123).

## MEASUREMENTS

	Males	Females
Head width	(14) 3.5–3.7, 3.63	(5) 4.1–4.5, 4.25
Posterior femur length	(14) 7.4–8.0, 7.85	(5) 8.9–9.3, 9.13
Posterior femur depth	(14) 2.3–2.9, 2.41	(5) 2.6–3.0, 2.79
Body length	(14) 13.2–15.0, 14.18	(5) 16.9–17.3, 17.13

## MATERIAL EXAMINED

Paratypes. Tanzania: 12 ♂, 5 ♀, same data as holotype (5 ♂, 3 ♀, COPR, London, rest BMNH); 1 ♀, Mpwapwa, Mt Wilkins, 1460 m, 10.iv.1938 (E. Burt) (BMNH); 1 ♂, Kikombo, Mpwapwa, 18.ix.1947 (BMNH).

*Usambilla emaliensis* sp. n.

(Figs 80, 81, 105, 106, 112, 125, 137–139)

Holotype ♂, Kenya: Emali range, Sultan Hamud, 1210–1790 m, iii.1940 (BMNH).

**DIFFERENTIAL DIAGNOSIS.** *Male.* Penis sheath bent in a smooth arc capitad as in *U. turgidicrus* (cf. Figs 132, 139). Epiphallal lophus bifurcate at tip (up to four teeth in *U. turgidicrus*) (Fig. 137). Form of frons and vertex much as in *U. turgidicrus* but otherwise differing as follows: upper margins of dark lateral body stripe smooth in profile (Fig. 104), not angulate as in Fig. 106; pronotal median carina forming a higher crest (Fig. 105) than in *U. turgidicrus*, in this respect near to *U. affinis*; hind femur (Fig. 112) distinctly green in outer and lower outer areas (always light brown with darker mottling in nominate subspecies of *U. turgidicrus*); length to depth ratio about 3.66 (only about 3.30 in nominate subspecies of *U. affinis*); frontal ridge (Figs 80, 81) weakly incised, unlike *U. turgidicrus* but like *U. affinis*.

*Female.* With much more pronounced pronotal crest than *U. turgidicrus* (Fig. 125). Hind femur much more long and slender (Fig. 125) (length to depth ratio 3.6; this ratio in subspecies of *U. turgidicrus* 3.2 or less).

## MEASUREMENTS

	Male holotype	Female paratype
Head width	3.20	3.75
Posterior femur length	7.36	9.05
Posterior femur depth	2.00	2.56
Body length	13.46	15.78

**Figs 142–153** Phallic complex of male *Usambilla* species. 142, *U. chlorophrygana* aedeagus, posterior apical aspect. 143, same, left lateral aspect. 144, same, epiphallus—upper right half and lateral plate, lower from right side. 145, epiphallus of *U. sagonai sagonai* (Kibale forest)—left right half and lateral plate, right—right lateral aspect. 146, same, aedeagus, left lateral aspect. 147, same, posterior apical aspect. 148, 149, *U. sagonai sagonai* female, ventral ovipositor valves from below and left side respectively. 150–152, *U. insolita* male (150) epiphallus—upper right half and lateral plate, lower right lateral aspect; (151) aedeagus, posterior apical aspect; (152) aedeagus, left lateral aspect. 153, supra-anal plate of *U. chlorophrygana* male. Scale line under Fig. 146 represents 0.5 mm and applies throughout.

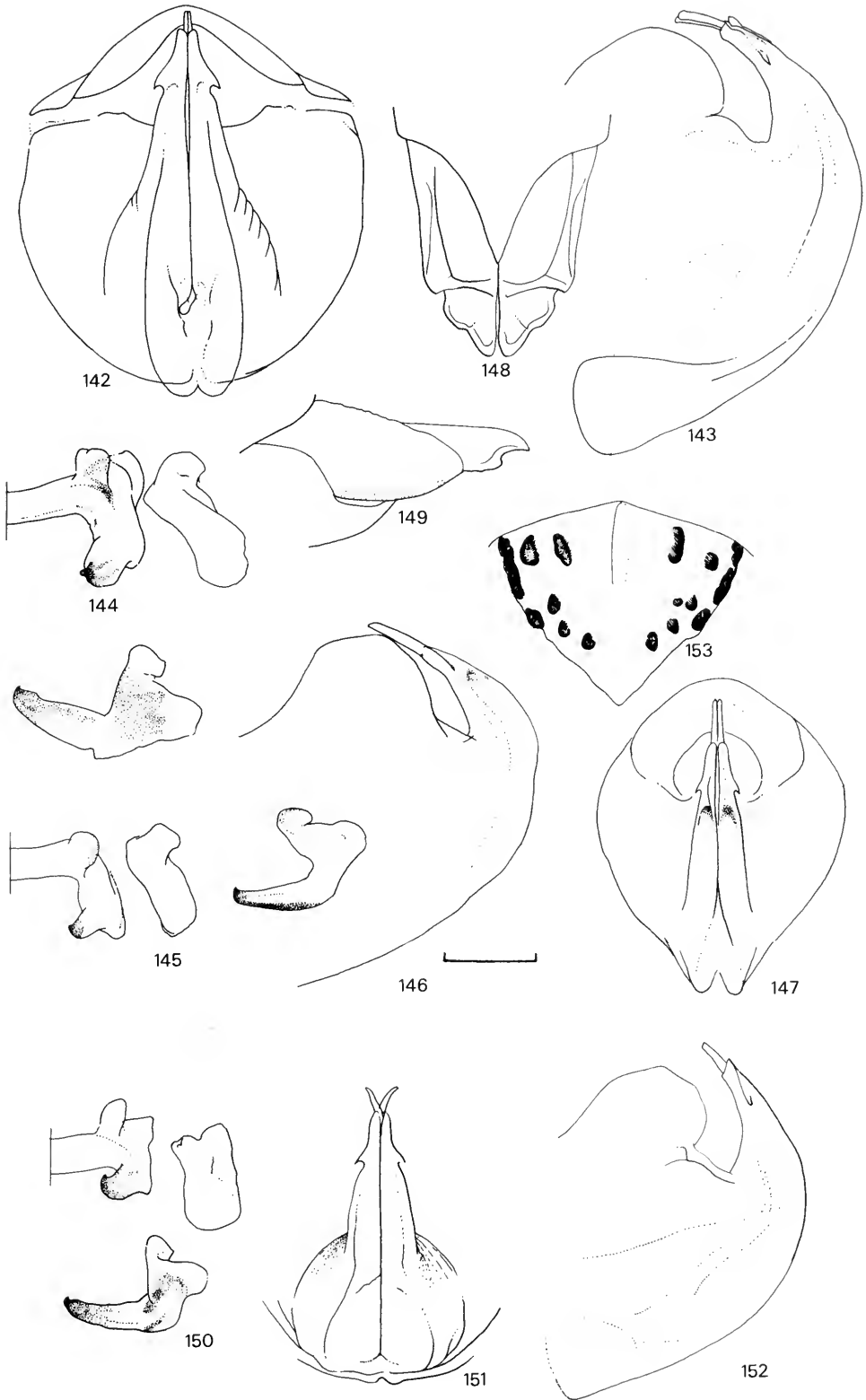

## MATERIAL EXAMINED

Paratype. **Kenya**: 1 ♀, same data as holotype (in copula) (BMNH).

DISCUSSION. This species may represent an isolated offshoot of *U. affinis* with which it shares the form of the vertex and pronotum. The very slender hind femora and high pronotal crest are, however, unique.

*Usambilla oraria* sp. n.

(Figs 75, 76, 95, 108, 121, 140, 141)

Holotype ♂, **Kenya**: Mombasa, [3-4.]vii.1939 (*E. Burt*) (BMNH).

DIFFERENTIAL DIAGNOSIS. *Male*. Vertex very narrow between compound eyes dorsally (Fig. 75), frontal ridge depressed, hardly protruding. Dark body stripes dark reddish brown; light longitudinal stripes creamy white. Lower lateral light band extending across epimera and episterna of thoracic segments 2 and 3. Hind femora very squat and inflated, length to depth ratio less than three (Fig. 108). Supra-anal plate (Fig. 95) very simple with four pairs of black callosities on the disc. Subgenital plate very short, folding under parameres for which there are two concave depressions in upper surface of subgenital plate itself. Cingular sheath small, rather abruptly tapered (Fig. 141) compared with *U. affinis* (Fig. 135). Epiphallus with bifurcate lophi (Fig. 140).

*Female*. Fastigium of vertex shallowly concave; frons hardly produced. Occiput with two large rugose ovoid depressions just behind back end of interocular groove. In lateral aspect with smooth convex dorsal profile giving a hump-backed appearance. Pronotum quite strongly tectiform. Hind femur short and stocky, length to depth ratio less than 3 (Fig. 121). Ventral ovipositor valves pointed.

General coloration light brown and dark brown pattern in both sexes. Hind femora unicolorous light brown (Fig. 108), though in darker females with dark comma anterior to knee lunules and marks on dorso-anterior part. Hind tibiae light ochrous brown, often blackish below, with black-tipped tibial spines.

## MEASUREMENTS

	Male	Females
Head width	3.50	(3) 4.5-5.3, 4.79
Posterior femur length	6.95	(3) 8.4-9.0, 8.74
Posterior femur depth	2.35	(3) 2.7-3.1, 2.93
Body length	11.53	(3) 15.6-17.1, 16.54

## MATERIAL EXAMINED

Paratypes. **Kenya**: 2 ♂, Mombasa, [3-4.]vii.1939 (*E. Burt*) (BMNH) [compared with holotype of *U. turgidicrus* by V. M. Dirsh]; 1 ♀, Mombasa, on *Vernonia hildebrandti*, 12.iii.1969 (BMNH); 1 ♀, Rabai, viii.1937 (*Van Someren*) (BMNH); 3 ♀, Arabuko for., 17 km W. of Malindi, 03°13'S, 39°56'E, 61 m, 11.vi.1975 (*Robertson & Robertson*) (COPR, London); 1 ♀, Arabuko-Sokoke For. Res., Jilore track, c.50 m, [2-3.]vi.1974 (*Hollis*) (BMNH). **Tanzania**: 2 ♀, Mlingano, Ngomeni, v.1952 (*Phipps*) (BMNH); 1 ♀, W. Usambara, Sumamagamba F. Res., 12.xi.1964 (*Jago*) (BMNH).

DISCUSSION. Probably one of the most truncated grasshoppers in proportion to its width known to science. It has a largely coastal forest distribution, with enclaves in piedmont forest in the west Usambara mountains. It belongs to the *affinis*-group of species.

*Usambilla chlorophrygana* sp. n.

(Figs 82, 83, 113, 114, 126, 142-144)

Holotype ♂, **Tanzania**: Kikombo, Mpwapwa, 16.iv.1947 (*E. Burt*) (BMNH).

DIFFERENTIAL DIAGNOSIS. *Male*. Large for the genus (see measurements). Fastigium of vertex strongly declivate, frons only protruding slightly in front of eyes. Anterior part of fastigium heavily pitted. Occiput with two oblique echelons of finely pitted cuticle terminating just behind interocular groove in two flat depressions (Fig. 82). Frons and genae wrinkled and punctate. Pronotum finely punctate with weak or obsolete dorsal carinula. Dorso-lateral and lateral light body stripes dull yellowish brown, upper band weak dorsad. Lateral creamy stripe extending across epimera and episterna of meso- and metathorax. Supra-anal plate with at least 3 pairs of distal black tubercles on disc (Fig. 153). Penis sheath strongly decurved capitad (Fig. 143) so that valves point forward. Epiphallus with bifurcate lophi simple; single hook at apex (Fig. 144).

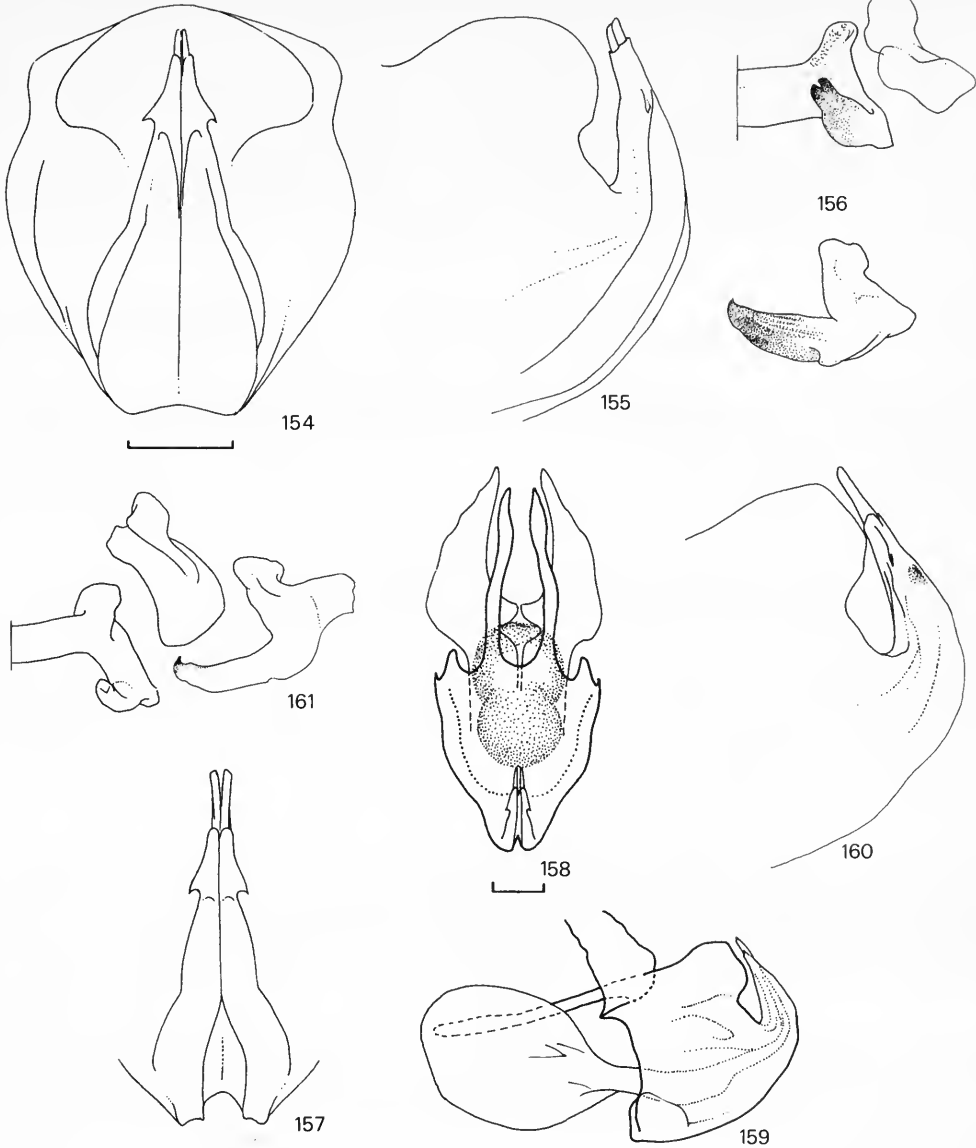

**Figs 154–161** Phallic complex of male *Usambilla* species. 154, *U. haematogramma* aedeagus, posterior apical aspect. 155, same, left lateral aspect. 156, same, epiphallus—upper right side and lateral plate, lower right lateral aspect. 157, *U. leptophrygana*, aedeagus, posterior apical aspect. 158, same, entire complex less epiphallus from above showing shape of ectophallic sheath and apodemes plus position of ejaculatory sacs (shaded). 159, same, entire complex less epiphallus, left lateral profile, showing broad flat spatulate anterior penis valves. 160, same, aedeagus left lateral view. 161, same, epiphallus—left right half and lateral plate, right lateral aspect. Scale lines represent 0.5 mm. Line under Fig. 154 applies to all except Figs 158, 159, to which scale line under Fig. 158 applies.

*Female*. Large (Fig. 126) with cuticle finely pitted. Female paratype badly discoloured but probably with light band of shiny cuticle across lower edge of pronotal side lobe.

Fastigium very wide, almost flat and punctate anteriorly (Fig. 83). Ovipositor valves apically pointed as in Fig. 188.

General coloration of male olivaceous brown with creamy orange dorso-lateral and lateral side stripes. Hind femora light green; knees light red-brown (Fig. 113). Hind tibiae light yellow-green to yellow, with black spines.

## MEASUREMENTS

	Male holotype	Female allotype
Head width	3.71	4.88
Posterior femur length	7.88	10.92
Posterior femur depth	2.51	3.15
Body length	15.36	20.89

## MATERIAL EXAMINED

Paratypes. **Tanzania**: 2 ♀, same data as holotype (BMNH); 1 ♂, data as holotype but 17.iv.1947 (*E. Burtt*) (BMNH); 1 ♂, data as holotype but 18.iv.1947 (*E. Burtt*) (BMNH); 1 ♂, data as holotype but 19.iv.1947 (*E. Burtt*); 2 ♂, Mpwapwa, Mt Wilkins, 1213 m, 4.iv.1938 (*E. Burtt*) (BMNH); 2 ♂, 1 ♀, 16.1 km N. of Ussure, Msigiri road, 12.iv.1936 (*E. Burtt*) (1 ♂, 1 ♀, COPR, London; 1 ♂, BMNH).

DISCUSSION. The name of this new species is derived from the Greek 'chloros'—green and 'phryganos'—twig or stick.

*Usambilla leptophrygana* sp. n.

(Figs 84, 85, 97, 115, 127, 157–161)

Holotype ♂, **Tanzania**: 70.8 km N. of Dodoma, 18.vi.1967 (*N. D. Jago*) (BMNH).

DIFFERENTIAL DIAGNOSIS. *Males*. Distinctive (Fig. 127) with well-marked to faint dark brown side stripe and conspicuous black markings on posterior femora (Fig. 115). Frons weakly to strongly incised in front (Fig. 84); fastigium of vertex excavate but much more produced than the similar *U. chlorophrygana* (Fig. 82). Overall colour light brown with dark markings. Hind femora not green in our series. Supra-anal plate with three basal tubercles on each side (Fig. 97) (see *U. chlorophrygana*, Fig. 153). Epiphallic lophus with single apical hook (Fig. 161), anterior penis valves (Figs 158, 159) typical for genus and illustrated here as representative, being flattened and vertically orientated. Aedeagal valves sloping strongly capitad (Figs 157, 159, 160).

*Female*. Dark pronotal side band weak, fading behind pronotal metazone and only intensifying just behind tympanum. Hind femur with pre-genicular black spot and dorso-basal spot always present, but row of three dark spots along lower outer carina variably developed (Fig. 127). Overall colour dull brown with darker brown markings. Median pronotal carina present, if weak, throughout.

## MEASUREMENTS

	Males	Females
Head width	(3) 3.5–3.6, 3.58	(5) 4.1–4.5, 4.31
Posterior femur length	(3) 7.7–8.4, 8.01	(5) 8.4–9.8, 9.19
Posterior femur depth	(3) 2.3–2.5, 2.41	(5) 2.8–3.1, 2.95
Body length	(3) 14.2–15.2, 14.81	(5) 16.4–18.5, 17.58

## MATERIAL EXAMINED

Paratypes. **Tanzania**: 3 ♀, same data as holotype but 16.vi.1967 (BMNH); 1 ♂, 2 ♀, Old Shinyanga, (1–8).iii.1947 (*E. Burtt*) (BMNH); 3 ♂, same data, 7.iii.1947 (BMNH); 3 ♂, same data, iii.1947 (BMNH); 1 ♂, same data, 12.iv.1947 (BMNH); 11 ♂, 5 ♀, same data, early iii.1947 (1 ♂, 1 ♀, COPR, London; rest BMNH); 7 ♂, Old Shinyanga, 30.iii.1947 (*E. Burtt*) (BMNH); 1 ♂, 1 ♀, same data 30.iv.1947 (BMNH); 1 ♂, Old Shinyanga, block 9, 23.v.1956 (*E. Burtt*) (BMNH); 2 ♂, same data, [22–24].iii.1948 (*E. Burtt*); 1 ♀, same data, 24.iv.1948 (*E. Burtt*) (COPR, London); 3 ♂, Mkwemi, 17.7 km W. of Kahama, 29.iii.1947 (*E. Burtt*) (BMNH); 1 ♀, Ruaha N. P., 15.iii.1966 (*Vesey-FitzGerald*) (BMNH).

DISCUSSION. The name of this species is derived from the Greek 'leptos'—slender, 'phryganos'—a twig.

*Usambilla insolita* (Rehn)

(Figs 86, 98, 150, 151)

*Adolfia insolita* Rehn, 1914: 148. Holotype ♂, CONGO: L. Kivu, Kwidschwi I. (MNHU, Berlin).

DIFFERENTIAL DIAGNOSIS. Only male paratype examined (ex alcohol). Very similar to *U. sagonai* (see Figs 86, 87, 88, 90). Differs in having a much narrower vertex and frontal ridge hardly produced forwards. Zone of dark brown or black pigment in *U. sagonai* (Fig. 90) apparently absent in *U. insolita*, but this may be due to



loss of colour after attempted preservation in alcohol. Supra-anal plate similar to that of *U. oraria* (Fig. 98) but differing in having subgenital plate extending much further beyond tip of supra-anal plate (see key, couplet 3) and hind femur more slender (see Figs 108, *oraria*; 116, *insolita*). Epiphallus (Fig. 150) with stout hook at tip of ventral lophi and penis apex curved in an arc cephalad (Figs 151, 152).

General colour pattern unknown.

#### MEASUREMENTS

	Male
Head width	3.32
Posterior femur length	7.51
Posterior femur depth	2.07
Body length	13.53

#### MATERIAL EXAMINED

Paratype. **Congo:** 1 ♂, Kwidschwi I., Lake Kivu, ix.1907 (*Adolf Friedrich Duke of Mecklenberg Expdn*) (COPR, London).

**DISCUSSION.** There is clear confusion in the original descriptions of species allocated to *Adolfia* by Ramme (1929) so that his expansion of *U. insolita* to include material from modern Zaire and the Ruwenzori region must be open to doubt. The paratype (topotype) examined here is different in detail from *U. sagonai* and is probably a species confined to the Kivu area only. It is replaced in Uganda by *U. sagonai*.

#### *Usambilla sagonai* (Ramme)

(Figs 88, 89, 90, 99, 100, 102, 103, 117, 128, 130, 145–149)

**DIFFERENTIAL DIAGNOSIS.** *Male.* Differing from all other *Usambilla* species by the following combination of characters: dorso-lateral and light lateral body stripes (Figs 102, 103) bright yellow; hind tibiae blue; frons only very slightly produced forwards as seen from above (Figs 88, 89); hind femora green, knee lunules light reddish brown (Fig. 117); supra-anal plate (Figs 99, 100) open to variation but in general with two pairs of basal black tubercles and two pairs of black tubercles near margin at centre of disc; frontal ridge less coarsely pitted than that of *U. insolita* (Figs 87, 90); penis valves sharply curved cephalad (Figs 146, 147); epiphallallic lophi with single apical hook (Fig. 145).

Generally brightly coloured species found in wet evergreen forest. Oblique yellow stripe across gena from base of eye complete or broken (subsp. *fractolineata*, Figs 102, 103).

*Female.* Ovipositor valvulae unspecialised; bluntly pointed (Figs 148, 149). Brightly coloured in various complex shades of green and brown (Fig. 130). In the darkest forms lateral pronotal lobe and area across thoracic segments II and III plus abdominal tergite 1 bear shining black bands. In more lightly pigmented specimens the black areas may be replaced by brown or dark green (Fig. 128). Side of pronotum, below dark band, bright yellow.

In both sexes pronotum is smoothly arched dorsally with median dorsal carinula weak or absent and cuticle finely punctate. In general appearance they converge on *Rhainopomma* species but have a wider inter-ocular groove, and, of course, apical barbs of the male aedeagus are preapical.

#### *Usambilla sagonai sagonai* Ramme

(Figs 88, 99, 130, 145–149)

*Adolfia sagonai* Ramme, 1929: 305, fig. 28c. Holotype ♂, ZAIRE; Lakes Region (MRAC, Tervuren) [examined].

**DIFFERENTIAL DIAGNOSIS.** Differs from subsp. *fractolineata* by possessing a yellow genal stripe which is entire.

#### MEASUREMENTS

	Males	Females
Head width	(12) 3.1–3.7, 3.46	(9) 3.8–4.1, 3.96
Posterior femur length	(12) 7.0–8.6, 7.95	(9) 8.4–9.4, 8.95
Posterior femur depth	(12) 2.0–3.5, 2.43	(9) 2.5–2.9, 2.60
Body length	(12) 12.4–15.0, 14.18	(9) 15.7–16.9, 16.44

## MATERIAL EXAMINED

**Zaire:** 1 ♂, 2 ♀, La Chute For., Rutchuru, 7.viii.1949 (*E. Burt*) (BMNH). **Rwanda:** 2 ♂, Kisenye, 10.viii.1949 (*E. Burt*) (BMNH). **Uganda:** 1 ♀, Toro, 1.6 km E. of Bundebugyo, 9.viii.1964 (*Jago*) (BMNH); 1 ♀, Kamanve, 17.ix.33 (*Johnston*) (BMNH); 1 ♀, Kilembe, 1370 m, xii.1934–i.1935 (*F. W. Edwards*) (BMNH); 1 ♂, Gaba, 18.x.1931 (*G. H. E. Hopkins*) (BMNH); 1 ♂, Nsagu, 3.ix.1933 (*Johnston*) (misdet. as *U. insolita* Rehn by B. P. Uvarov) (BMNH); 1 ♂, Ruwenzori, 1610 m, 1913 (*Scott-Elliott*) (misdet. as *U. insolita* Rehn by Ramme) (BMNH); 8 ♂, 6 ♀, Toro, SE. of Ft Portal, Kibale for. res., 30°25'E, 0°30'N, [13–16.]viii.1964 (*Jago*) (2 ♂, 2 ♀, COPR, London; rest BMNH); 1 ♂, 1 ♀, same data, 30.iv.1967 (*Jago*) (BMNH); 1 ♀, Ruwenzori, between road and Nyabitaba hut below 2610 m, 27.vi.1963 (*P. & P. Carter*) (BMNH). **Kenya:** 1 ♂, 1 ♀, Kakamega For. Statn, c. 1520 m, [18–19.]vii.1974 (*Hollis*) (BMNH).

**DISCUSSION.** The recent discovery of this subspecies in Kenya extends its known distribution to the forests of the east side of Lake Victoria. It is possible that the nominate race occurs south and west of the lake while subsp. *fractolineata* represents an isolated series of populations on its northern side in the Mabira to Mpanga forest blocks of the Nile drainage and northwards to Lake Albert.

*Usambilla sagonai fractolineata* subsp. n.

(Figs 89, 90, 100, 102, 103, 117, 128)

**Holotype** ♂, **Uganda:** Buganda, Mpanga F. Res., km 33.8 Kampala–Masaka road, 32°20'E, 0°15'N, [2–3.]viii.1964 (*Jago*) (BMNH).

**DIFFERENTIAL DIAGNOSIS.** Differing from nominate subspecies only in respect of the broken lateral yellow band across the gena in the male (Figs 102, 103).

## MEASUREMENTS

	Males	Females
Head width	(24) 3.3–4.4, 3.71	(29) 3.8–4.4, 4.09
Posterior femur length	(24) 7.4–8.9, 8.09	(29) 8.1–9.8, 9.18
Posterior femur depth	(24) 2.1–2.4, 2.24	(29) 2.3–2.9, 2.58
Body length	(24) 13.6–15.5, 14.65	(29) 15.7–18.9, 17.15

## MATERIAL EXAMINED

**Paratypes.** **Uganda:** 4 ♀, 1 nymph, Bunyoro, W. of Masindi, Budongo F. Res., 31°30'E, 1°48'N, [25–27.]viii.1964 (*Jago*) (BMNH); 6 ♂, 2 ♀, Buganda, Mabira F. Res., nr Jinja, 33°0'E, 0°25'N, 27.iv.1967 (*Jago*) (BMNH); 10 ♂, 16 ♀, 7 nymphs, same data as holotype (COPR, London); 1 ♂, 1 ♀, Mpanga F. Res., nr Kampala, 30.viii.1969 (*E. S. Brown*) (BMNH); 1 ♀, Mpanga F. Res., 1210 m (BMNH); 1 ♂, Bunyoro, Lake Albert, Butiaba, [26–28.]viii.1964 (*Jago*) (BMNH); 1 ♂, 3 ♀, Bunyoro, Bugoma F. Res., S. of Hoima, 31°0'E, 1°15'N, [29–31.]viii.1964 (*Jago*) (BMNH); 4 ♂, 2 ♀, Mubende, Mubende reservoir, 19.viii.1964 (*Jago*) (BMNH).

*Usambilla haematogramma* sp. n.

(Figs 92, 93, 101, 118, 129, 154–156)

**Holotype** ♂, **Tanzania:** Ufipa plateau, 25.8 km NNW. of Sumbawanga, Mkundi plantation, [16–27.]v.1966 (*Jago*) (BMNH).

**DIFFERENTIAL DIAGNOSIS.** *Male.* Inter-ocular groove and fastigium of vertex wide (Fig. 92), frontal ridge flat. Antennae longer than head and pronotum. Hind femora (Fig. 118) entirely pale green, except knee which is light brown; hind tibiae light green, dark brown in apical half on inner and lower side, spines black-tipped. Supra-anal plate (Fig. 101) with dark lateral infuscate areas and four pairs of simple tubercles. Colour, as for females (Fig. 129), distinctive—body pale emerald green with median dorsal black line above and broad black line on each side from behind compound eye to back of tergite 8 of abdomen. This lateral line demarcated above by a red line extending from front of pronotum to at least rear of tergite 1 of abdomen; demarcated below by a dull yellow band bordered with black ventrally. Cerci conical with narrow pre-apical black annulus. Subgenital plate pale green. Aedeagal valves (Figs 154, 155) gently curved capitad; epiphallal lophi (Fig. 156) apically bifurcate.

*Female.* Colour as for male (Fig. 129) and in this respect unusual for the genus. Combination of colours unique. Note that mid-dorsal black line may be very faint or absent.

## MEASUREMENTS

	Males	Females
Head width	(35) 3.3–3.5, 3.37	(25) 4.1–4.8, 4.20
Posterior femur length	(35) 7.5–9.2, 8.29	(24) 9.0–11.9, 10.42
Posterior femur depth	(35) 2.1–2.7, 2.27	(24) 2.9–3.2, 2.88
Body length	(35) 13.9–17.5, 15.18	(24) 17.8–21.7, 19.45

## MATERIAL EXAMINED

Paratypes. **Tanzania**: 2 ♂, 3 ♀, 4 nymphs, Ilemba gap, 12.iii.1959 (*Vesey-FitzGerald*); 4 ♂, 2 ♀, 1 nymph, Nsangu, 2120 m, 13.iii.1959 (*Vesey-FitzGerald*); 6 ♂, 3 ♀, Ufipa escarpment, [6–9.]vii.1948 (*Waloff*); 2 ♂, Malonje, Ufipa, 8.iv.1951 (*Vesey-FitzGerald*); 1 ♀, Mpui, 100 km N. of Abercorn, 17.vi.1947 (*B. P. Uvarov*); 3 ♂, 5 ♀, Ufipa plateau, 25.8 km NNW. of Sumbawanga, Mkundi, [16–27.]v.1966 (*Jago*); 2 ♂, 6 ♀, E. of Sumbawanga, Mbisi F. Res., [23–29.]v.1966 (*Jago*), 9 ♂, 3 ♀, 19.3 km E. of Sumbawanga, Malonje Mt, plateau grassland, disused road to Mpui, [24–28.]v.1966 (*Jago*); 2 ♂, 2 ♀, Rukwa valley, 8 km W. of Muse, bottom descent Red Locust road, 26.v.1966 (*Jago*); 10 ♂, 5 ♀, Mbisi For. Res., v.1966 (*Jago*); 9 ♂, 2 ♀, Ufipa, Nsangu F. Res., Sumbawanga-Mpui road, 28.v.1966 (*Jago*). (Last series COPR, London; rest BMNH.)

**DISCUSSION.** The species derives its name from the Greek 'haematos'—bloody, 'grammos'—a line, emphasising the distinctive dorso-lateral orange-red line which delineates the upper margin of the black lateral stripe. The general coloration is very similar to that of members of the genus *Lentula* but the phallic complex shows that *U. haematogramma* has a strong affinity with the *olivacea*-group of lentulids.

## References

- Dirsh, V. M.** 1956. Orthoptera, Acridoidea. In Hanström, B., Brinck, P. & Rudebeck, G., *S. Afr. anim. Life* 3: 121–272, 2 pls, 42 figs.
- Dirsh, V. M.** 1968. A new genus and species of the family Lentulidae (Orthoptera: Acridoidea). *Proc. R. ent. Soc. Lond. (B)* 37: 143–145, 2 figs.
- Jago, N. D.** 1978. The systematic position of *Physocrobylus burtti* Dirsh, 1951 with description of the previously undescribed male sex. *Acrida* 7: 79–83, 7 figs.
- Karsch, F.** 1896. Neue Orthopteren aus dem tropischen Afrika. *Stettin. ent. Ztg* 57: 242–359, 38 figs.
- Kevan, D. K. McE.** 1950. Orthoptera from the hills of south-east Kenya. *Jl E. Africa nat. Hist. Soc.* 19: 192–221, pl. 34, 5 figs.
- Kevan, D. K. McE. & Knipper, H.** 1961. Geradflügler aus Ostafrika (Orthopteroidea, Dermapteroidea, Blattopteroidea). *Beitr. Ent.* 11: 356–413, 9 pls, 12 figs.
- Ramme, W.** 1929. Afrikanische Acrididae. Revisionen und Beschreibungen wenig bekannter und neuer Gattungen und Arten. *Mitt. zool. Mus. Berl.* 15: 247–492, 16 pls, 106 figs.
- Rehn, J. A. G.** 1914. Orthoptera I. Mantidae, Phasmidae, Acrididae, Tettigoniidae und Gryllidae aus dem Zentral-Afrikanischengebiet Uganda und dem Ituri-Becken des Kongos. *Wiss. Ergebn. dt. Zent Afr.-Exped. 1907–1908* 5(1): 1–223.
- Sjöstedt, Y.** 1909. *Wissenschaftliche Ergebnisse der Schwedischen Zoologischen Expedition nach dem Kilimandjaro, dem Meru und den umgebenden Massaiesteppen Deutsch-Ostafrikas 1905–1906.* 17. Orthoptera. 7. Acridoidea: 149–199, 1 pl., 2 figs.
- Uvarov, B. P.** 1939. Twenty four new generic names in Orthoptera. *Ann. Mag. nat. Hist.* (11) 3: 457–459.
- Whellan, J. A.** 1975. The Acridoidea of Malawi: an annotated check list. *Acrida* 4: 105–122.
- 1976. Notes on the genus *Mecostibus* Karsch, 1896 (Orthoptera: Lentulidae). *Arnoldia, (Rhodesia)* 8(1): 1–6, 8 figs.

## Index

Synonyms are in *italics*; principal references are in **bold**.

- Acacia 10, 21, 27  
*Adolfia* 20  
affinis 21, 22, 23, 24, 25, **27**, 28, 29, 30, 32  
Albizzia 17  
Altiusambilla 1, 3, **12**  
Aresceutica 13  
aspera, Achyranthes 8
- Bacteracris 5  
Basutacris 4  
Betiscoides 5  
burtii, Chromousambilla 2, 4, 6, 7, 8, **9**  
burtii, Physocrobylus 10
- Catantopinae 13  
chlorophrygana 21, 23, 24, 25, 26, 30, 31, **32**, 34  
Chromothericles 1  
Chromousambilla 1, 3, **5**, 16, 20  
Combretum 21, 27  
Commelina 17  
Commiphora 21, 27  
cylindricollis 10, 11, **12**
- Devylideria 4
- emaliensis 13, 21, 23, 24, 25, 26, 28, 29, **30**  
Eremidium 4  
Erlangea 8
- fractolineata 21, 22, 23, 25, 26, 35, **36**
- Gymnidium 4
- haematogramma 8, 20, 21, 22, 24, 25, 26, 33, **36**  
Helwigacris 5  
hookeri, Pseudarthria 8
- insolita 20, 21, 22, 25, 30, 31, **34**, 35  
Kalaharicus 3  
Karruacris 3  
Karruia 4  
kikomboensis 21, 23, 25, 26, 27, 29, **30**
- latestriata 2, 4, 5, **6**, 7, 8, 9, 10  
Lentula 3, 12, 37  
leptophrygana 21, 22, 23, 24, 25, 26, 33, **34**  
magnificum 14, 15, 17, 18, **20**  
Malawia 1, 3  
Mecostiboides 3  
Mecostibus 1, 2, 3  
Microusamilla 1, 3, **10**, 12  
modicrus 1, 2, 11, **12**, 13, 16  
montanum 2, 13, 14, 15, **16**, 18, 19  
mweruensis 2, 4, 5, 6, 7, 8, **9**
- nguruense 14, 15, 16, **17**, 18  
Nyassacris 1, 3
- olivacea, Usambilla, 20, 23, 24, 25, 26, **27**  
olivacea, Lentula 37  
oraria 21, 22, 24, 25, 26, 28, **32**, 35
- Paralentula 3  
patula, Pinus 1, 13  
peruviana, Physalis 8  
Plagiotriptus 1
- Qachasia 5
- Rhainopomma 1, 4, 12, 35  
*Rehnula* 20  
robertsoni 2, 4, 6, 7, 8, 9, **10**
- ragonai 20, 21, 22, 23, 24, 26, 30, 31, 34, **35**  
Serpusia 13  
Shelfordites 3  
steppia, Bidens 8  
stuhlmanni, Pycnostachys (?) 8  
Swaziacris 4  
Sygrus 3, 12
- turgidicus 20, 21, 22, 23, **24**, 25, 26, 28, 29, 30
- usambaricum 13, 14, 15, **16**, 17, 18, 19  
Usambilla 1, 2, 4, 5, 10, 13, 17, 20
- verticillaris, Hypoestes 8  
veseyi 2, 4, 5, 6, 7, **8**, 9, 10
- wapugu 14, 15, 16, 17, **19**





**British Museum (Natural History)**  
**1881—1981**

**Centenary Publications**

***Chance, change & challenge***

Two multi-author volumes from one of the foremost scientific institutions in the world.

General Editor: P. H. Greenwood

**The Evolving Earth**

Editor: L. R. M. Cocks

**The Evolving Biosphere**

Editor: P. L. Forey

In the first volume, *The Evolving Earth*, twenty scientists have been asked to review the present state of knowledge in their particular field, ranging from the origin of the Earth, through ocean sediments and soils to continental drift and palaeogeography.

In the companion volume, *The Evolving Biosphere*, museum scientists have chosen an evolutionary concept—speciation, coevolution, biogeography etc. and related this to the group of animals or plants in which they are specialising. Thus beetles and birds exemplify sympatric and allopatric speciation, butterflies mimicry and certain fishes explosive evolution.

In both volumes the text is supplemented by over one hundred specially-commissioned pieces of two-colour artwork.

These two books will be invaluable to all sixth-form and undergraduate biology and geology students.

*The Evolving Earth*: 276 × 219 mm, 280pp, 138 line illustrations, 42 halftones

*The Evolving Biosphere*: 276 × 219 mm, approx. 320pp, 133 line illustrations

Published: May 1981

Co-published by the British Museum (Natural History), London and Cambridge University Press, Cambridge.

## **Titles to be published in Volume 42**

**A revision of the genus *Usambilla Sjöstedt* (Orthoptera : Acridoidea) and its allies.  
By N. D. Jago.**

**The Asian, Australasian and Pacific Paraboloponinae (Homoptera : Cicadellidae).  
A taxonomic revision with a key to all the known genera of the subfamily.  
By M. D. Webb.**

**A revision of *Phyciodes* Hübner and related genera, with a review of the classification  
of the Melitaeinae (Lepidoptera : Nymphalidae). By L. G. Higgins.**

**A revision of six minor genera of Myrmicinae (Hymenoptera : Formicidae) in the  
Ethiopian zoogeographical region. By Barry Bolton.**



# Bulletin of the British Museum (Natural History)

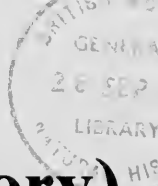

## The Asian, Australasian and Pacific Paraboloponinae (Homoptera: Cicadellidae)

A taxonomic revision with a key to all the known genera  
of the subfamily

M. D. Webb

4

Entomology series  
Vol 43 No 2

24 September 1981

The *Bulletin of the British Museum (Natural History)*, instituted in 1949, is issued in four scientific series, Botany, Entomology, Geology (incorporating Mineralogy) and Zoology, and an Historical series.

Papers in the *Bulletin* are primarily the results of research carried out on the unique and ever-growing collections of the Museum, both by the scientific staff of the Museum and by specialists from elsewhere who make use of the Museum's resources. Many of the papers are works of reference that will remain indispensable for years to come.

Parts are published at irregular intervals as they become ready, each is complete in itself, available separately, and individually priced. Volumes contain about 300 pages and are not necessarily completed within one calendar year. Subscriptions may be placed for one or more series. Subscriptions vary according to the contents of the Volume and are based on a forecast list of titles. As each Volume nears completion, subscribers are informed of the cost of the next Volume and invited to renew their subscriptions. Orders and enquiries should be sent to :

Publications Sales,  
British Museum (Natural History),  
Cromwell Road,  
London SW7 5BD,  
England.

*World List* abbreviation: *Bull. Br. Mus. nat. Hist.* (Ent.)

© Trustees of the British Museum (Natural History), 1981

ISSN 0524-6431

British Museum (Natural History)  
Cromwell Road  
London SW7 5BD

Entomology series  
Vol 43 No 2 pp 39-76

Issued 24 September 1981

# The Asian, Australasian and Pacific Paraboloponinae (Homoptera: Cicadellidae)

A taxonomic revision with a key to all the known genera  
of the subfamily

M. D. Webb

Department of Entomology, British Museum (Natural History), Cromwell Road, London  
SW7 5BD

## Contents

Synopsis . . . . .	39
Introduction and historical review . . . . .	39
Acknowledgements . . . . .	40
Abbreviations and depositories . . . . .	40
Paraboloponinae Ishihara . . . . .	41
Key to the genera of Paraboloponinae . . . . .	41
<i>Parabolopona</i> Matsumura . . . . .	42
Key to species of <i>Parabolopona</i> (males only) . . . . .	43
<i>Favintiga</i> gen. n. . . . .	47
<i>Dryadomorpha</i> Kirkaldy . . . . .	49
Key to Asian, Australasian and Pacific species of <i>Dryadomorpha</i> (males only) . . . . .	50
<i>Rhutelorbus</i> gen. n. . . . .	56
<i>Parohinka</i> gen. n. . . . .	57
Key to species of <i>Parohinka</i> . . . . .	59
Males . . . . .	59
Females . . . . .	59
<i>Karoseefa</i> gen. n. . . . .	70
Key to species of <i>Karoseefa</i> . . . . .	71
<i>Oceanopona</i> Linnavuori . . . . .	73
References . . . . .	75
Index . . . . .	76

## Synopsis

The subfamily Paraboloponinae is redefined and a key is provided to the nine genera recognized, of which four are new. The Asian, Australasian and Pacific genera are fully revised for these regions, with keys to the 25 species (18 new) recognized. Four new generic synonymies, ten new specific synonymies and six new combinations are established. Seven lectotypes and one neotype are newly designated.

## Introduction and historical review

The family Paraboloponidae was erected by Ishihara in 1953 as a subdivision of the Cicadelloidea (now Paraboloponinae and Cicadellidae respectively) for the Japanese genus *Parabolopona* Matsumura, containing two species, *P. guttata* (Uhler) and *P. camphorae* Matsumura. In Ishihara's description of the subfamily he distinguished it from others in Japan by the cylindrical form, conically produced vertex and long antennae. In 1960 Linnavuori listed the group as a tribe of the Deltocephalinae and described a new genus and species, *Oceanopona croceipennis*, from the Caroline Is., and in 1974 Eyles & Linnavuori raised the group to subfamily level and included *Calotettix* Osborn, containing *metrosideri* Osborn and *metrosideri* var. *tincta* Osborn, from the Marquesas Is., and a new species, *lais*, from the Cook Is. In 1975 Hamilton added the Holarctic genera *Stymphylus* Stål, containing *rubrolineata* Stål and *modestus* Linnavuori (transferred to the

Deltocephalinae by Linnavuori in 1978), *Yakunopona* Ishihara, with one species, *yakushimensis* Ishihara, from Japan, and *Zizyphoides* Distant, containing *indicus* Distant, *fraternus* Distant and *punctatus* Rao from India and *quadricornis* Linnavuori from Africa. In addition Hamilton drew further attention to the long, dorsally situated antennae as a means of identifying the subfamily. In 1978 Linnavuori revised the Paraboloponinae from the Ethiopian region and redefined the group as having falcate anterior tentorial branches, dorsally situated antennae, deep antennal pits delimited by a relatively distinct dorsal ledge and the ocelli not visible from above. He added *Dryadomorpha* Kirkaldy, containing *pallida* Kirkaldy, *lotophagorum* Kirkaldy and *viridia* Osborn from Australia, Fiji and the Marquesas Is. respectively, and *Stenomiella* Evans, containing one species, *viridis* Evans, from Africa; he also described a new genus *Odmiella* for *Stenomiella falcata* Linnavuori, from Africa. In addition, the genus *Paganalia* Distant with one species, *virescens* Distant, from the Seychelles, was transferred to the subfamily as a senior synonym of *Zizyphoides* and *Rhombopsana* Metcalf, the latter a replacement name for *Rhombopsis* Haupt and containing *virens* (Haupt) from Palestine and *chatterjeei* (Singh-Pruthi) and *viridis* (Singh-Pruthi) from India. The species *Z. fraternus* was transferred to *Stirellus* Osborn & Ball (Deltocephalinae), a new species of *Paganalia* from Africa (*anacryon*) was described and *Platymetopius antennalis* Lindberg, from the Canary Is., was synonymized with *Paganalia virens*. The latter species was synonymized with *Paganalia virescens* by Webb (1980).

Whilst identifying Paraboloponinae from material in the British Museum (Natural History) and elsewhere I discovered four new genera and 18 new species from Asia, Australasia and the Pacific and found that many previous descriptions were inadequate. In addition, the species *Parabolopona camphorae*, *Dryadomorpha lotophagorum* and *Muirella longiseta* Melichar, the latter previously included in the Coelidiinae, were found to belong to other genera. A number of generic and specific synonymies were also discovered.

The subfamily characters given by previous workers are for the most part confirmed by the present study, although of those listed by Linnavuori in 1978 (see above) the antennal ledge is sometimes absent and the ocelli are often visible from above. The male genitalia of the group are similar to those of the Deltocephalinae with Y-shaped connective, but those of *Parabolopona* are somewhat distinct from the remaining genera in having a long membranous connection between the connective and the aedeagus, the apex of the connective extended posteriorly and the basal apodeme of the aedeagus, in some species, horizontal and compressed dorsoventrally. The genus *Favintiga* is unusual within the Cicadellids in having a ventroapical process on the connective.

The aim of the present paper is to revise the known genera of Paraboloponinae, other than *Odmiella* and *Stenomiella* from Africa (revised by Linnavuori in 1978), to describe new genera and species from the Asian, Australasian and Pacific regions, to redescribe the subfamily and to provide a key to the known genera.

### Acknowledgements

For the loan of material in their care I would like to thank the following: Dr P. H. Arnaud, CAS, San Francisco; Dr M. Boulard, MNHN, Paris; Dr O. B. Chhotoni, ZSI, Calcutta; Dr J. Dlabola, NM, Prague; Dr P. H. van Doesburg, RNH, Leiden; Dr K. G. A. Hamilton, CNC, Ontario; Dr Y. Hirashima, ELKU, Fukuoka; Dr J. P. Kramer, USNM, Washington; Dr M. Meinander, ZMU, Helsinki; Dr G. M. Nishida, BPBM, Honolulu; Dr P. K. Sen-Sarma, FRI, Dehra Dun; Dr S. Takagi, EIHU, Sapporo; Dr T. Weir, ANIC, Canberra; Dr K. A. J. Wise, IM, Auckland. I would also like to thank Dr J. Evans for the loan of material in his private collection, Mrs G. Nakahashi and Professor J. Medler for sorting material from the Bishop Museum collection, Dr T. Ishihara and Dr C. A. Viraktamath for their helpful communications and Dr W. J. Knight for the information contained in his unpublished check list on the Pacific Cicadellidae.

### Abbreviations of depositories

The specimens studied in the course of this work are deposited in the various institutions and private collections whose names are abbreviated in the text as follows: The South Australian Museum, Adelaide, South Australia (SAM, Adelaide); Auckland Institute and Museum, Auck-

land, New Zealand (IM, Auckland); Department of Scientific and Industrial Research, Auckland, New Zealand (DSIR, Auckland); Zoological Survey of India, Calcutta, India (ZSI, Calcutta); [Australian National Insect Collection.] C.S.I.R.O., Canberra, Australia (ANIC, Canberra); The Ohio State University, Columbus, Ohio, U.S.A. (OSU, Columbus); Zoologisk Museum, Copenhagen, Denmark (ZM, Copenhagen); Forest Research Institute, Dehra Dun (U.P.), India (FRI, Dehra Dun); Entomological Laboratory, Kyushu University, Fukuoka, Japan (ELKU, Fukuoka); Zoological Museum of the University, Helsinki, Finland (ZMU, Helsinki); Bernice P. Bishop Museum, Honolulu, Hawaii, U.S.A. (BPBM, Honolulu); private collection of Professor Dr H. J. Muller, Jena, D.D.R. (HJM, Jena); Rijksmuseum van Natuurlijke Historie, Leiden, Netherlands (RNH, Leiden); British Museum (Natural History), London, United Kingdom (BMNH, London); [Canadian National Collection.] Ottawa, Ontario, Canada (CNC, Ontario); Muséum National d'Historie Naturelle, Paris, France (MNHN, Paris); Národní Muzeum, Prague, Czechoslovakia (NM, Prague); California Academy of Sciences, San Francisco, California, U.S.A. (CAS, San Francisco); Entomological Institute, Hokkaido University, Sapporo, Japan (EIHU, Sapporo); private collection of Dr J. W. Evans, Sydney, Australia (JWE, Sydney); [U.S. National Museum.] National Museum of Natural History, Washington, U.S.A. (USNM, Washington).

### PARABOLOPONINAE Ishihara

Paraboloponidae Ishihara, 1953: 20. Type-genus: *Parabolopona* Matsumura.

Paraboloponini; Linnavuori, 1960: 299.

Paraboloponinae; Eyles & Linnavuori, 1974: 39.

Yellow, greenish yellow or brownish yellow, often apex of clavus and claval veins with a small brown spot.

Head as wide or wider than pronotum; anterior margin rounded or rim-like, transversely striate, ocelli on margin distant from eyes, anterior tentorial branches curved anteriorly, not bifurcate. Vertex triangularly produced with fine longitudinal striations. Face as wide or wider than long, shagreen; antennae very long, arising near dorsal corners of eyes; antennal pits deep; antennal ledges slight or absent; clypeus with lateral margins constricted near antennae; clypellus elongate, usually with sides concave, rarely with sides parallel; lora large. Pronotum with sides very short to moderately long, with or without a carina; transversely striate, with anterior region rugose or shagreen. Scutellum shagreen or shagreen and obscurely rugose posteriorly. Forewing with three subapical cells, the first subapical cell open and the second and third closed; subcostal region usually with a few veinlets near to fifth apical cell. Fore tibia with setal arrangement 1: 4.

Male genitalia with pygophore lobes long with several long spine-like setae. Xth segment short to long, without processes. Valve triangulate. Subgenital plate elongate, triangulate with short to long fine marginal setae dorsally. Connective Y-shaped with stem short to long, arms short. Style with lateral lobe and apical process short to moderately long, with a few sensory papilla and sometimes setae adjacent preapical lobe; basal apophyses weak to strongly developed. Aedeagus usually closely attached to connective; shaft cylindrical, narrow, tapered to apex, usually symmetrical, processes usually at or near apex sometimes basal; basal apodeme usually vertical, rarely horizontal.

Female genitalia with second valvulae elongate, usually slightly expanded distally with a short to long dorsal sclerotized region, with or without a dorsal prominence.

**BIOLOGY.** The few recorded host plants of Paraboloponinae are shrubs and small trees. *Favintiga camphorae* is found on *Cinnamomum camphora* Nees & Ebermaier, *Dryadomorpha pallida* on *Zizyphus jujuba* Miller and *Dryadomorpha metrosideri* on *Glochidion ramiflorum* J. R. & G. Forster, *Rapanea* sp., *Reynoldsia* sp. and *Weinmannia parviflora* G. Forster.

**DISTRIBUTION.** The subfamily is confined to the Old World where it is found mainly in Asia and Australasia but also extends into the Pacific and the Ethiopian region.

#### Key to the genera of Paraboloponinae

- |   |   |   |
|---|---|---|
| 1 | Side margins of pronotum carinate, moderately long (Fig. 1). Setal arrangement at apex of hind femur 2 + 2 + 1 or 2 + 2 + 0 | 2 |
| - | Side margins of pronotum not carinate, short (Fig. 41). Setal arrangement at apex of hind femur 2 + 1 + 1 or 2 + 1 + 0      | 4 |

- 2 Vertex with medial length approximately twice length next to eye. 12–15 setae in fore femur series (Fig. 3). Setal arrangement at apex of hind femur 2 + 2 + 1. (Asia as far south as Nepal to the Philippines: Luzon) 3
- Vertex with medial length approximately four times length next to eyes. 3–4 setae in fore femur series. Setal arrangement at apex of hind femur 2 + 2 + 0. (Africa) . . . . . **ODMIELLA** Linnavuori
- 3 Dorsum yellow or yellow tinged with green. Fore margin of head rim-like (Fig. 5). Vertex shagreen . . . . . **PARABOLOPONA** Matsumura (p. 42)
- Dorsum brownish yellow. Fore margin of head rounded (Fig. 33). Vertex finely longitudinally striate . . . . . **FAVINTIGA** gen. n. (p. 47)
- 4 Vertex shagreen and obscurely rugose. Setal arrangement at apex of hind femur 2 + 1 + 0 . . . . . **OCEANOPONA** Linnavuori (p. 73)
- Vertex longitudinally striate or rugose. Setal arrangement at apex of hind femur 2 + 1 + 1 . . . . . 5
- 5 Length approximately 10.0 mm. Male pygophore lobes with a long process; subgenital plates shorter than pygophore. (Africa) . . . . . **STENOMIELLA** Evans
- Length not exceeding 8.7 mm. Male pygophore lobes without a process; subgenital plates longer than pygophore (Fig. 53). (Africa and Oriental region) . . . . . 6
- 6 Clypellus with sides parallel (Fig. 151). 10 setae in fore femur series . . . . . **KAROSEEFA** gen. n. (p. 70)
- Clypellus with sides concave (Fig. 42). 3–7 setae in fore femur series . . . . . 7
- 7 Vertex and pronotum rugose. Lateral margins of face adjacent to eyes visible dorsally (Fig. 68) . . . . . **RHUTELORBUS** gen. n. (p. 56)
- Vertex and pronotum longitudinally striate. Lateral margins of face not visible dorsally (Fig. 41) . . . . . 8
- 8 Vertex without pale patches. Female genitalia with posterior margin of pregenital sternite with a small protuberance each side of midline (Fig. 51); dorsal margin of second valvulae with an anterior prominence (Fig. 56). Male genitalia with aedeagus symmetrical . . . . . **DRYADOMORPHA** Kirkaldy (p. 49)
- Vertex with or without pale patches. Female genitalia with posterior margin of pregenital sternite without a protuberance each side of midline; dorsal margin of second valvulae without an anterior prominence (Fig. 133). Male genitalia with aedeagus asymmetrical . . . . . **PAROHINKA** gen. n. (p. 51)

### **PARABOLOPONA** Matsumura

*Parabolopona* Matsumura 1912: 288. Type-species: *Parabolocratius guttatus* Uhler, by original designation.

Yellow to greenish yellow; forewings with a small brown spot on apex of clavus, on apex of veins of clavus and apical cells and a variable brown spot on first *m-cu* cross vein and base of inner vein of second subapical cell.

Head as wide as pronotum; anterior margin rim-like, carinate; ocelli on margin, distant from eyes, visible from above; anterior tentorial branches curved anteriorly, not bifurcate. Vertex triangularly produced, medial length approximately twice length next to eyes; sides slightly convex or slightly angularly rounded; apex narrowly angularly rounded; shagreen, transversely striate anteriorly. Face slightly wider than long, shagreen; upper margin depressed medially with a few transverse striations; face in profile more or less straight; clypeus moderately long and narrow, lateral margins constricted near antennae; clypellus elongate, expanded apically; transclypeal suture visible; lora large; antennal pit deep with inner margin more or less angularly rounded to clypeus; antennal ledge slight; antennae very long, when recurved extending to near apex of clavus. Pronotum approximately twice as wide as long, side margins moderately long, carinate; irregularly and transversely striate, shagreen anteriorly. Scutellum approximately equal in length to pronotum, shagreen, obscurely rugose posteriorly. Fore wing with three subapical cells, first subapical cell open, second and third subapical cells closed. Fore tibia with dorsal setal arrangement 1: 4; fore femur with a series of 12–14 fine setae distally on anterior surface; hind femur with apical setal formula 2 + 2 + 1 with the proximal and more dorsal of the middle setae slightly narrower than others.

Apodemes of male third abdominal segment ventral, reduced.

Male genitalia with anterior margin of pygophore straight in dorsal aspect, with or without an apodeme on each side; pygophore lobes with several macrosetae and numerous short fine setae. Xth segment moderately long, cylindrical. Valve triangular. Subgenital plate moderately long, triangular, apical region digitate and lightly sclerotized; ventral surface with several short setae; outer margin of dorsal surface with a few moderately long fine setae on basal lobe and usually towards apex of plate. Style moderately long with basal apophysis and lateral lobe prominent; apical process moderately long, curved ventrally and tapered to apex or with apex foot-like, crenulate dorsally; region adjacent preapical lobe with a few sensory papilla ventrally

and a few short fine setae dorsally. Connective Y-shaped with stem produced posteriorly, not articulated with aedeagus at apex but with a long membranous connection from approximately midlength of stem; arms short. Aedeagus with shaft straight or curved posteroventrally, short with a pair of apical processes; gonopore situated at apex on posterior surface; basal apodeme large, either vertical and compressed anteroposteriorly or horizontal around base of shaft and compressed dorsoventrally.

Female genitalia with second valvulae united at midlength (arrowed in Fig. 14) and slightly expanded distally, without a basal prominence; dorsal teeth very fine, extending approximately one-quarter distance from apex to base of valvulae; dorsal sclerotized region short to long.

**REMARKS.** This genus is similar to *Favintiga* with the lateral margins of the pronotum moderately long and carinate and the hind femur with a setal formula 2 + 2 + 1; it differs, however, in the more rim-like fore margin of the head and the shagreen rather than longitudinally striate vertex. In the male genitalia the horizontal and dorsoventrally compressed basal apodeme of the aedeagus in some species, the produced stem of the connective and the distant relationship of the aedeagus and connective to each other are unique within the subfamily.

**DISTRIBUTION.** Asia as far south as Nepal to the Philippines (Luzon).

### Key to species of *Parabolopona* (males only)

- 1 Aedeagus with a pair of apical processes; stem of connective without setae . . . . . 2
- Aedeagus with a pair of basal processes; stem of connective with setae. (Philippines) *luzonensis* sp. n. (p. 46)
- 2 Aedeagus with apical processes directed away from base of shaft in lateral aspect, gonopore small . . . . . 3
- Aedeagus with apical processes directed towards base of shaft in lateral aspect; gonopore large (Figs 16, 17) . . . . . *ishihari* sp. n. (p. 45)
- 3 Aedeagal shaft strongly curved (Fig. 8); connective with apex upturned and expanded laterally (Figs 7, 13). (Japan and Taiwan) . . . . . *guttata* (Uhler) (p. 43)
- Aedeagal shaft weakly curved (Fig. 20); connective with apex straight and narrow. (China) *chinensis* sp. n. (p. 45)

### *Parabolopona guttata* (Uhler)

(Figs 1–14)

*Parabolocratus guttatus* Uhler, 1896: 291. LECTOTYPE ♂, JAPAN (USNM, Washington), here designated [examined].

*Parabolopona guttata* (Uhler) Matsumura, 1912: 288.

Length: ♂, 6.6–7.0 mm, mean 6.8 mm; ♀, 7.0–8.0 mm, mean 7.5 mm.

Colour and external characters as in generic description.

Male genitalia with pygophore lobes angularly rounded posteriorly; anterior margin of pygophore with a prominent apodeme on each side. Connective with apex upturned and expanded laterally. Style with apical process tapered to apex. Aedeagus with shaft elongate, curved posteroventrally and continued ventrally as a pair of elongate diverging processes; gonopore small; basal apodeme horizontal, compressed dorsoventrally around base of shaft (Fig. 12).

Female genitalia with posterior margin of pregenital sternite sinuate; second valvulae with dorsal sclerotized region short.

**REMARKS.** The male genitalia of *guttata* are similar to those of *chinensis* but the pygophore lobes are broader, the apex of the connective is upturned and expanded laterally and the aedeagal shaft is strongly curved with the apical processes expanded subapically without a small lateral protuberance basally.

**DISTRIBUTION.** Japan and Taiwan.

### MATERIAL EXAMINED

*Parabolocratus guttatus* Uhler, lectotype ♂, Japan: Gifuyama, 7.vii.1888 [in Japanese] (USNM, Washington).

Japan: numerous specimens from Honshu and Kyushu (BMNH, London; EIHU, Sapporo; ELKU, Fukuoka); 1 ♀, Gifuyama, 7.vii.1888 [in Japanese] (USNM, Washington) (paralectotypes of *Parabolocratus guttatus* Uhler). Taiwan: 1 ♂, 1 ♀, Tattaka, 16, 19.viii.1921; 3 ♀, Hassenzan, Taichū-shū, Reimei, 13–14.vii.1932 (ELKU, Fukuoka).

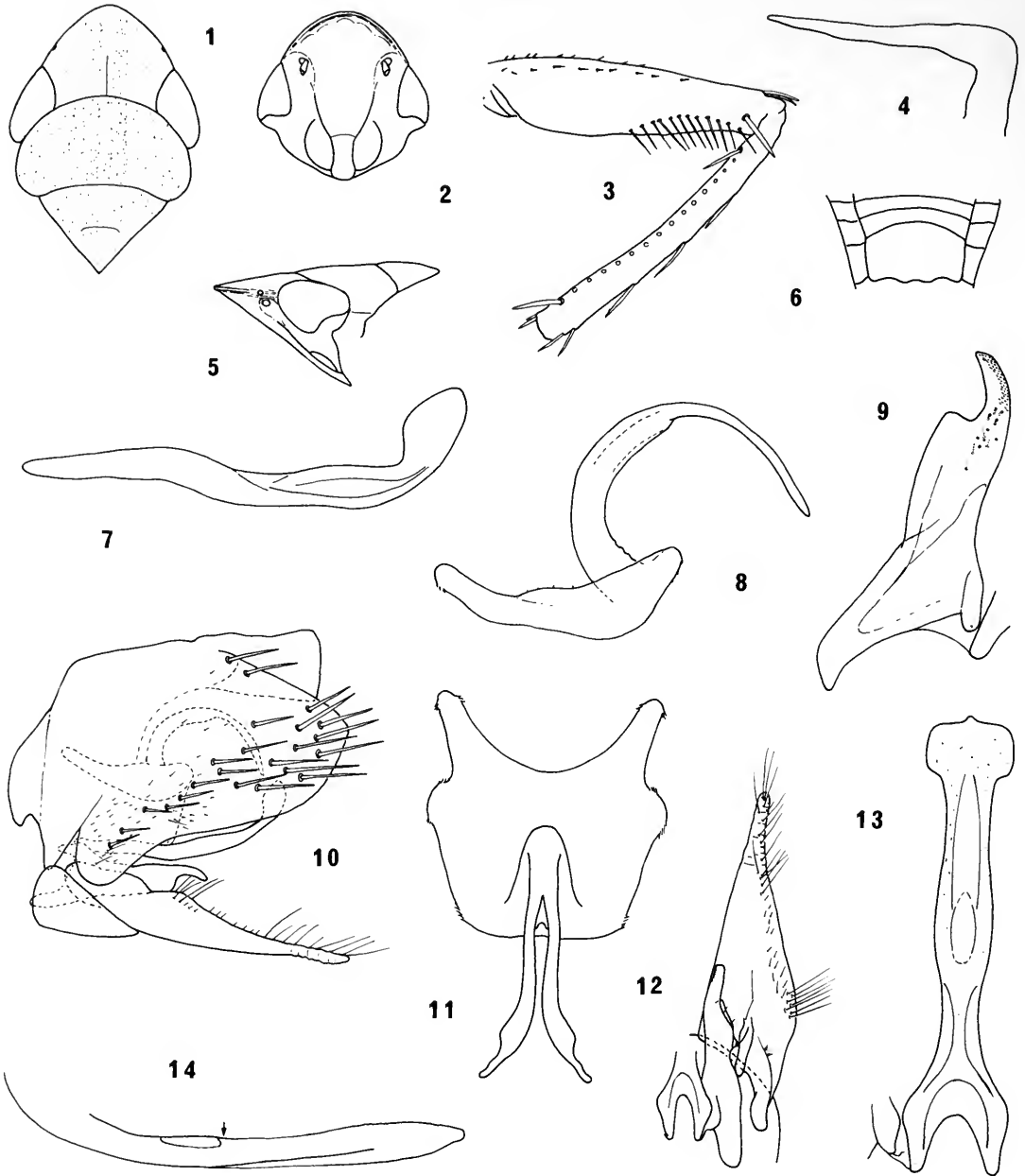

**Figs 1–14** *Parabolopona guttata*. 1, head and thorax, dorsal view; 2, face; 3, left fore leg, anterior view; 4, left anterior tentorial branch, lateral view; 5, head and thorax, lateral view; 6, ♀ pregenital segments, ventral view; 7, connective, lateral view; 8, aedeagus, lateral view; 9, left style, ventral view; 10, ♂ genital capsule, lateral view; 11, aedeagus, dorsal view; 12, left subgenital plate and style and connective, dorsal view; 13, connective, dorsal view; 14, second valvulae, lateral view.



*Parabolopona ishihari* sp. n.

(Figs 15–19)

Length: ♂, 6.6 mm; ♀, 7.5 mm.

Colour and external characters as in generic description.

Male genitalia with pygophore lobes acute posteriorly; anterior margin without an apodeme on each side. Connective with basal stem straight and narrow throughout length. Style with apical process tapered to apex. Aedeagus with shaft short and robust, more or less straight, terminating in a pair of moderately long ventrally directed processes; gonopore large; basal apodeme horizontal, compressed dorsoventrally around base of shaft (Figs 16, 17).

Female genitalia as in *guttata*.

**REMARKS.** The male genitalia of *ishihari* are similar to those of *guttata* but the pygophore lobes are more acute posteriorly, the apex of the connective is straight and narrow and the aedeagus has the processes directed towards the base of the shaft in lateral aspect and the gonopore large.

DISTRIBUTION. Japan.

## MATERIAL EXAMINED

Holotype ♂, Japan: Northern Honshu, Towada, vii.1905 (EIHU, Sapporo).

Paratypes. Japan: 1 ♂, 1 ♀, same data as holotype (BMNH, London; EIHU, Sapporo).

*Parabolopona chinensis* sp. n.

(Figs 20–21)

Length: ♂, 6.4 mm.

Colour and external characters as in generic description.

Male genitalia with pygophore and connective similar to *ishihari* (Figs 15, 18) but pygophore with an apodeme on each side anteriorly and posterior lobes less acute; remaining structures similar to *guttata* but

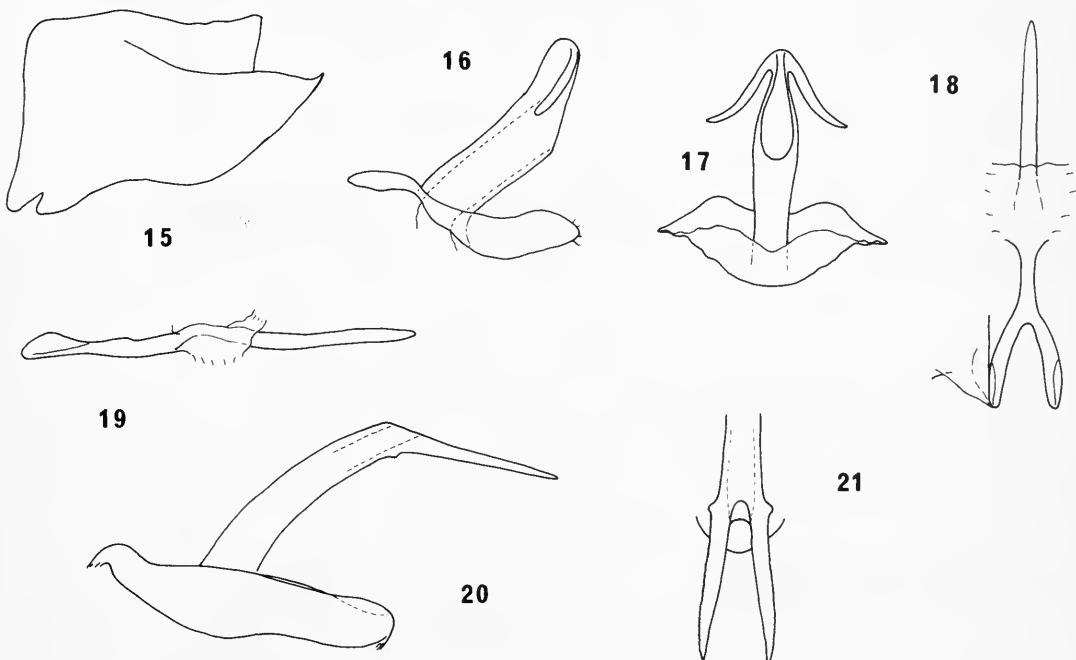

**Figs 15–21** *Parabolopona* species. 15–19. *P. ishihari*. (15) ♂ pygophore, lateral view; (16, 17) aedeagus, lateral and posterior views; (18, 19) connective, dorsal and lateral views. 20, 21, *P. chinensis*. (20) aedeagus, lateral view; (21) apex of aedeagus, dorsal view.

connective straight and narrow apically and aedeagal shaft only slightly curved with apical processes evenly tapered from base to apex with a small lateral protuberance basally.

Female genitalia unknown.

REMARKS. This species is similar to *guttata* but differs in the male genitalia as noted above. From *ishihari* with a similarly shaped pygophore and connective (see above), *chinensis* differs in having the aedeagal processes directed away from the shaft in lateral aspect.

DISTRIBUTION. Central China.

MATERIAL EXAMINED

Holotype ♂, China: Hubei-Sichuan border, trail between Mo-Tai-Chi and Sang-Hou-Ken, 19.vii.1948 (*Gressitt & Djou*) (CAS, San Francisco).

*Parabolopona luzonensis* sp. n.

(Figs 22–27)

[*Parabolocratrus guttatus* Uhler; Merino, 1936: 364. Misidentification.]

Length: ♂, 6.7–7.3 mm, mean 7.0 mm; ♀, 7.3–8.2 mm, mean 8.0 mm.

Colour and external characters as in generic description.

Male genitalia with pygophore lobes narrowly rounded posteriorly; anterior margin of pygophore without apodemes. Connective with stem nearly straight, tapered to acute apex; distal region with numerous short stout setae dorsally. Style with apical process foot-like apically in lateral aspect. Aedeagus with shaft short and robust, curved dorsally, apex with a slight lamellate expansion arising from anterior margin on each side; a pair of moderately long, dorsally directed processes, arising basally from posterior margin; gonopore moderately large; basal apodeme vertical, compressed anteroposteriorly.

Female genitalia with posterior margin of pregenital sternite produced medially; second valvulae with dorsal sclerotized region elongate.

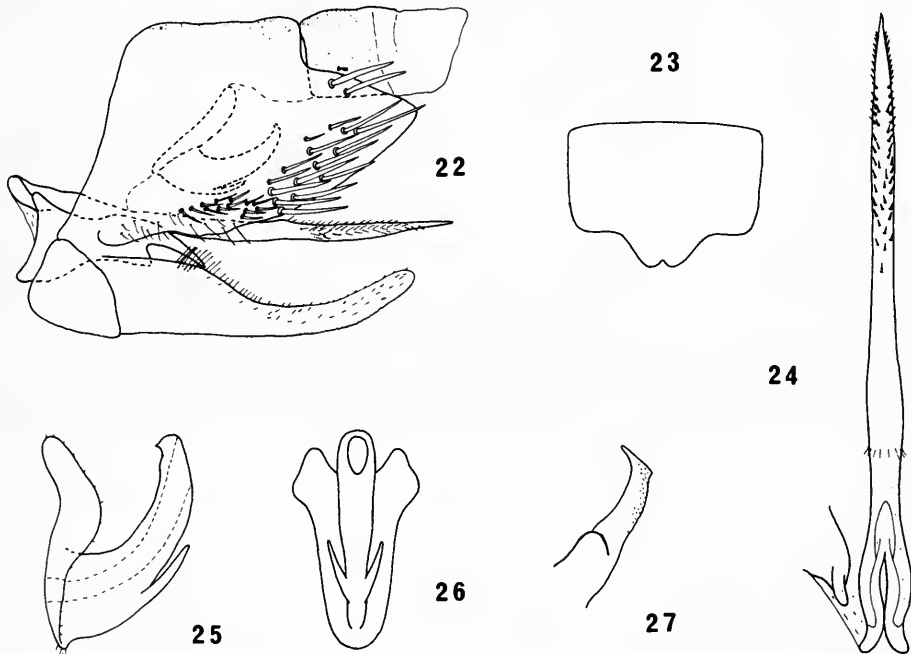

Figs 22–27 *Parabolopona luzonensis*. 22, ♂ genital capsule, lateral view; 23, ♀ pregenital sternite; 24, connective, dorsal view; 25, 26, aedeagus, lateral and posterior views; 27, apex of style, lateral view.

REMARKS. This species can be distinguished from other members of the genus by the foot-like apex of the style and the aedeagus with the processes arising basally rather than apically and the basal apodeme being vertical rather than horizontal. The female genitalia can be distinguished by the medially produced posterior margin of the pregenital sternite and the elongate dorsal sclerotized region of the second valvulae.

DISTRIBUTION. Philippines (Luzon).

MATERIAL EXAMINED

Holotype ♂, **Philippines**: Luzon, Baguio, Benguet (*Baker*) (USNM, Washington).

Paratypes. **Philippines**: 10 ♂, 19 ♀, same data as holotype (1 ♂, 1 ♀ in BMNH, London; remainder in USNM, Washington); 1 ♂, Luzon, Heights Plane (OSU, Columbus).

*FAVINTIGA* gen. n.

Type-species: *Parabolopona camphorae* Matsumura, 1912.

Brownish yellow dorsally, pale yellow ventrally; fore wings with a small brown spot near mid length of subcostal region, on apex of clavus and on apex of veins of clavus, apical cells and additional vein in subcostal region.

Head as wide as pronotum; anterior margin angularly rounded in profile, transversely striate, becoming carinate and rim-like medially; ocelli on margin, distant from eyes, visible from above; anterior tentorial branches curved anteriorly, not bifurcate. Vertex triangularly produced, medial length approximately twice length next to eyes, sides slightly convex; apex moderately broadly rounded; finely longitudinally striate, transversely striate anteriorly. Face slightly wider than long, more or less straight in profile; shagreen; clypeus moderately long, narrow, lateral margins constricted near antennae; clypellus elongate, expanded apically; transclypeal suture visible; lora large; antennal pit deep with inner margin obliquely inclined to clypeus; antennal ledge slight; antennae very long, extending to near apex of clavus. Pronotum approximately twice as wide as long, sides moderately long, carinate; finely and transversely striate, shagreen and more or less smooth anteriorly, Scutellum approximately equal in length to pronotum, shagreen, obscurely rugose posteriorly. Fore wings with three subapical cells, first subapical cell open, second and third subapical cells closed; an additional veinlet in subcostal region near to fifth apical cell. Fore tibia with dorsal setal arrangement 1 : 4; fore femur with a series of 15 fine setae distally on anterior surface; hind femur with apical setal formula 2 + 1 + 1 with the proximal and more dorsal of the middle setae slightly narrower than others.

Apodemes of male third abdominal segment ventral, reduced.

Male genitalia with anterior margin of pygophore straight dorsally, without apodemes; pygophore lobes with several macrosetae and short fine setae. Xth segment moderately long, cylindrical. Valve triangulate. Subgenital plates moderately long, distal half digitate and lightly sclerotized; dorsal surface with a few moderately long fine setae on basal lobe and a few very short setae distally, Style moderately long with basal apophyses and lateral lobe prominent; apical process moderately long, curved ventrally and tapered apically, crenulate medially; a few sensory papilla medially adjacent lateral lobe. Connective Y-shaped; stem long, lateral margins keel-like dorsally; a bifurcate process distally on ventral surface; arms short. Aedeagus large, laterally compressed with an elongate preatrium; shaft curved dorsally and tapered apically with a pair of basal processes; gonopore situated at apex on posterior surface, elongate; basal apodeme elongate.

Female genitalia with second valvulae united at first dorsal tooth (arrowed in Fig. 38), narrow throughout length in lateral aspect with a slight dorsoanterior prominence; dorsal teeth very fine, extended over approximately distal third of valvulae; dorsal sclerotized region elongate.

REMARKS. This genus is similar externally to *Parabolopona* (see remarks under that genus) but the long preatrium of the aedeagus and the processes on the connective are unique within the subfamily.

DISTRIBUTION. Japan and Amama-Oshima I. (south of Japan).

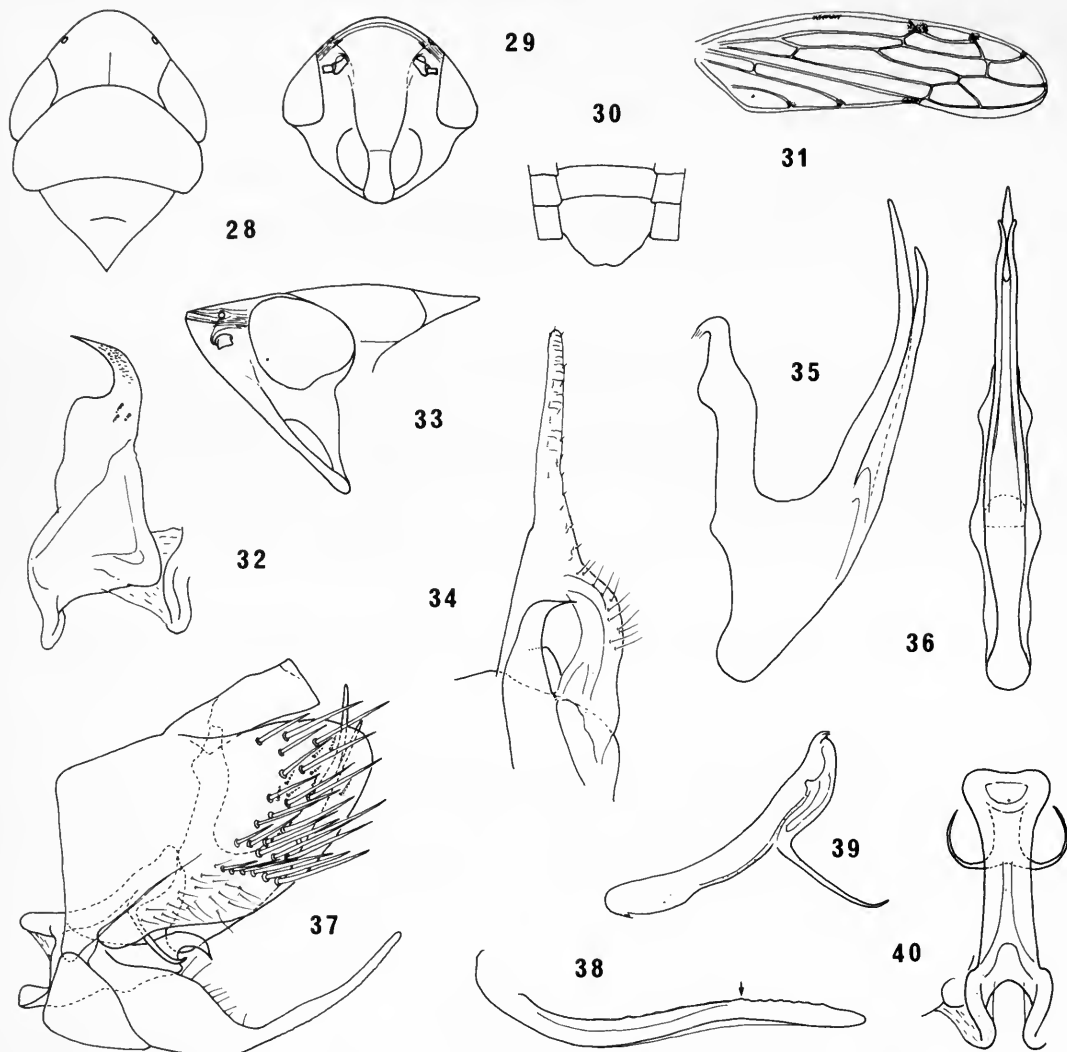

**Figs 28–40** *Favintiga camphorae*. 28, head and thorax, dorsal view; 29, face; 30, ♀ pregenital segments, ventral view; 31, fore wing; 32, left style, ventral view; 33, head and thorax, lateral view; 34, left subgenital plate and apex of left style, dorsal view; 35, 36, aedeagus, lateral and posterior views; 37, ♂ genital capsule, lateral view; 38, second valvulae, lateral view; 39, 40, connective, lateral and dorsal views.

***Favintiga camphorae* (Matsumura) comb. n.**

(Figs 28–40)

*Parabolopona camphorae* Matsumura, 1912: 288. LECTOTYPE ♀, JAPAN (EIHU, Sapporo), here designated [examined].

Length: ♂, 6 mm; ♀, 6.3–7.0 mm, mean 6.6 mm.

Colour and external characters as in generic description.

Male genitalia as in generic description with apical process of style with a small subapical tooth on medial surface and connective with each branch of ventral process elongate, tapered to apex and curved ventromedially. Aedeagus with shaft elongate; processes arising against posterior margin on each side, extended dorsally close to shaft and terminating a little before its apex, evenly tapered from base to apex.

Female genitalia with posterior margin of pregenital sternite convex; second valvulae as in generic description.

REMARKS. This species is distinguishable by its brownish yellow colour dorsally and its distinctive male genitalia as noted above.

DISTRIBUTION. Japan and Amami-Oshima I. (south of Japan).

MATERIAL EXAMINED

*Parabolopona camphorae* Matsumura, lectotype ♀, **Japan**: S. Kyushu, Kagoshima, 10.vii.1903 (EIHU, Sapporo).

**Japan**: 1 ♀, same data as lectotype (paralectotype of *Parabolopona camphorae* Matsumura); 1 ♂, 1 ♀, Honshu, Gifuyama, 7.vii.1888 (USNM, Washington); 3 ♀, Amami-Oshima I., Yakkachi, Sumiyo-mura, 17–18.vii.1933 (*Esaki & Yasumatsu*) (ELKU, Fukuoka, BMNH, London).

**DRYADOMORPHA** Kirkaldy

*Dryadomorpha* Kirkaldy, 1906: 335. Type-species: *Dryadomorpha pallida* Kirkaldy, by monotypy.

*Paganalia* Distant, 1917: 314. Type-species: *Paganalia virescens* Distant, by monotypy. **Syn. n.**

*Zizyphoides* Distant, 1918: 73. Type-species: *Zizyphoides indicus* Distant, by original designation. [Synonymized by Linnavuori 1978: 459.]

*Rhombopsis* Haupt, 1927: 22. Type-species: *Rhombopsis virens* Haupt, by monotypy. [Homonym of *Rhombopsis* Gardner, 1916: 456.]

*Calotettix* Osborn, 1934: 247. Type-species: *Calotettix metrosideri* Osborn, by original designation. [Homonym of *Calotettix* Bruner, 1908: 309.]

*Yakunopona* Ishihara, 1954: 12. Type-species: *Yakunopona yakushimensis* Ishihara, by original designation.

**Syn. n.**

*Rhombopsana* Metcalf, 1967: 229. [Replacement name for *Rhombopsis* Haupt.] [Synonymized by Linnavuori, 1978: 459.]

*Osbornitettix* Metcalf, 1967: 229. [Replacement name for *Calotettix* Osborn.] **Syn. n.**

*Khamiria* Dlabola, 1979: 252. Type-species: *Khamiria mangrovecola* Dlabola, by original designation.

**Syn. n.**

Yellow, greenish yellow or stramineous; fore wings with either a small brown spot at apex of both clavus and claval veins or inner margin of clavus bordered with brown. Legs spotted with brown.

Head wider than pronotum; anterior margin angularly or acutely rounded in profile, transversely striate, sometimes becoming carinate and rim-like in longer headed forms; ocelli on margin distant from eyes, not or slightly visible from above; anterior tentorial branches curved anteriorly, not bifurcate. Vertex triangularly produced, medial length 1.5–3.0 times length next to eyes, sides slightly convex to concave, apex fairly broadly angularly rounded to acute in longer headed forms; with a longitudinal depression; finely longitudinally striate, transversely striate anteriorly. Face elongate to only slightly longer than wide, shagreen; upper margin slightly depressed each side of mid line in longer headed forms forming a faintly striate longitudinal keel medially; face in profile convex to more or less straight, concave anteriorly in longer headed forms; clypeus elongate, lateral margins constricted near antennae; clypellus elongate, expanded apically; trans-clypeal suture distinct or indistinct; lora large; antennal pit deep with inner margin angularly rounded to clypeus, sometimes faintly rim-like and nearly carinate; antennal ledge very slight; antennae very long, extending to beyond apex of clavus when recurved. Pronotum approximately twice as wide as long, sides very short, without a carina; finely and transversely striate, obscurely rugose anteriorly. Scutellum approximately equal in length to pronotum, shagreen with posterior region obscurely rugose. Fore wing with three subapical cells, first subapical cell open, second and third subapical cells closed; one or two additional veinlets in subcostal region near to fifth apical cell. Fore tibia with dorsal setal arrangement 1:4; fore femur with a series of seven setae distally on anterior surface; hind femur with apical setal formula 2 + 1 + 1 with first proximal seta slender.

Apodemes of male third abdominal segment ventral, reduced.

Male genitalia with anterior margin of pygophore straight dorsally, without apodemes; pygophore lobes with an oblique internal ledge terminating at ventroposterior margin with a darkly pigmented area, pygophore lobes with several macrosetae and short to moderately long fine setae. Xth segment moderately long, compressed dorsoventrally. Valve triangulate. Subgenital plates elongate, triangular; ventral surface of lateral lobe with a more heavily sclerotized region apically; outer margin with numerous long fine setae on dorsal and ventral surfaces; apex with a few short stout setae. Style moderately long with basal apophyses prominent; apical process moderately long, curved ventrally and tapered to acute or rounded apex, crenulate distally; a few sensory papilla ventrally, adjacent lateral lobe. Connective Y-shaped, stem short to moderately long with lateral margins keel-like dorsally; arms short. Aedeagus with shaft elongate, curved

dorsally and tapered to apex with two or four apical, dorsally directed processes; gonopore small, apical on posterior surface; basal apodeme moderately long and narrow.

Female genitalia with posterior margin of pregenital sternite with a small protuberance each side of mid line; second valvulae united at first dorsal tooth (arrowed in Fig. 56), slightly expanded distally, fairly robust with a dorsoanterior prominence; dorsal teeth robust, unaligned, extending to near mid length of valvulae; dorsal sclerotized region moderately long.

REMARKS. This genus is represented in the southern Palaearctic region by *Dryadomorpha pallida* Kirkaldy (also present in Africa, Asia and Australasia and described below), and *D. mangrovecola* (Dlabola) **comb. n.** Also present in Africa are *D. anacyron* (Linnavuori) **comb. n.** and *D. quadricornis* (Linnavuori) **comb. n.** (both species adequately described by Linnavuori, 1978: 462). Two species incorrectly described in *Zizyphoides* (= *Dryadomorpha*) are *Z. fraternus* Distant belonging to the genus *Stirellus* Osborn & Ball (Linnavuori, 1978: 460) and *Z. punctatus* Rao **syn. n.** of *Mahalana lugubris* Distant.

Externally *Dryadomorpha* is almost identical to *Rhutelorbus* and *Parohinka* but differs in lacking the pale patches on the head (usually present in *Parohinka* and sometimes in *Rhutelorbus*), the striate vertex and pronotum (rugose in *Rhutelorbus*), the lateral margins of the face adjacent to the eyes not being visible dorsally (just visible in *Rhutelorbus*) and the posterior margin of the female pregenital sternite being transverse (posterior corners produced in *Rhutelorbus* and *Parohinka* or broadly V- or U-shaped in *Parohinka*). The male genitalia are similar to *Karoseefa* but have the anterior margin of the pygophore straight dorsally and without apodemes. In the female genitalia the second valvulae are similar to those of *Parohinka* but with a dorsoanterior prominence present.

DISTRIBUTION. Ethiopian and southern Palaearctic region, Asia, Australasia and the Pacific.

#### Key to Asian, Australasian and Pacific species of *Dryadomorpha* (males only)

- 1 Aedeagus with apical processes strongly divergent (Fig. 52) . . . . . 2
- Aedeagus with apical processes weakly divergent (Fig. 62) . . . . . 3
- 2 Aedeagal processes slightly expanded at mid length in posterior aspect (Fig. 52); fore wings with a small brown spot at apex of both clavus and claval veins (Fig. 47). (Ethiopian, southern Palaearctic and Oriental regions as far south as Singapore and Java and northern and north-eastern Australia) . . . . . *pallida* Kirkaldy (p. 50)
- Aedeagal processes narrow throughout length in posterior aspect (Fig. 60); fore wings without a small brown spot at apex of both clavus and claval veins, sometimes inner margin of clavus brown (Fig. 58). (Marquesas Is., Cook Is. and northern Australia) . . . . . *metrosideri* (Osborn) (p. 53)
- 3 Aedeagal shaft robust (Fig. 63); style with apical process tapered to apex (Fig. 61). (Malaya, Borneo (Sarawak and Sabah)) . . . . . *robustipenis* sp. n. (p. 54)
- Aedeagal shaft slender (Fig. 66); style with apical process rounded or foot-like apically (Figs 64, 65). (Borneo (Sarawak and Sabah)), New Guinea and Vanuatu . . . . . *pacifica* sp. n. (p. 55)

#### *Dryadomorpha pallida* Kirkaldy

(Figs 41–56)

- Dryadomorpha pallida* Kirkaldy, 1904: 336. Holotype ♀, AUSTRALIA, (BPBM, Honolulu) [examined].  
*Paganalia virescens* Distant, 1917: 314. Lectotype ♀, SEYCHELLES (BMNH, London), designated by Webb (1980: 848) [examined]. **Syn. n.**  
*Zizyphoides indicus* Distant, 1918: 73. LECTOTYPE ♀, INDIA (BMNH, London), here designated [examined]. **Syn. n.**  
*Rhombopsis virens* Haupt, 1927: 23. Lectotype ♂, ISRAEL (HJM, Jena), designated by Webb (1980: 848) [examined]. **Syn. n.**  
*Rhombopsis viridis* Singh-Pruthi, 1930: 34. LECTOTYPE ♂, INDIA (ZSI, Calcutta), here designated [examined]. **Syn. n.**  
*Rhombopsis chatterjeei* Singh-Pruthi, 1934: 26. LECTOTYPE ♂, INDIA (FRI, Dehra Dun), here designated [examined]. **Syn. n.**  
*Platymetopius antennalis* Lindberg, 1958: 181. Holotype ♂, CAPE VERDE IS. (ZMU, Helsinki) [examined]. **Syn. n.**

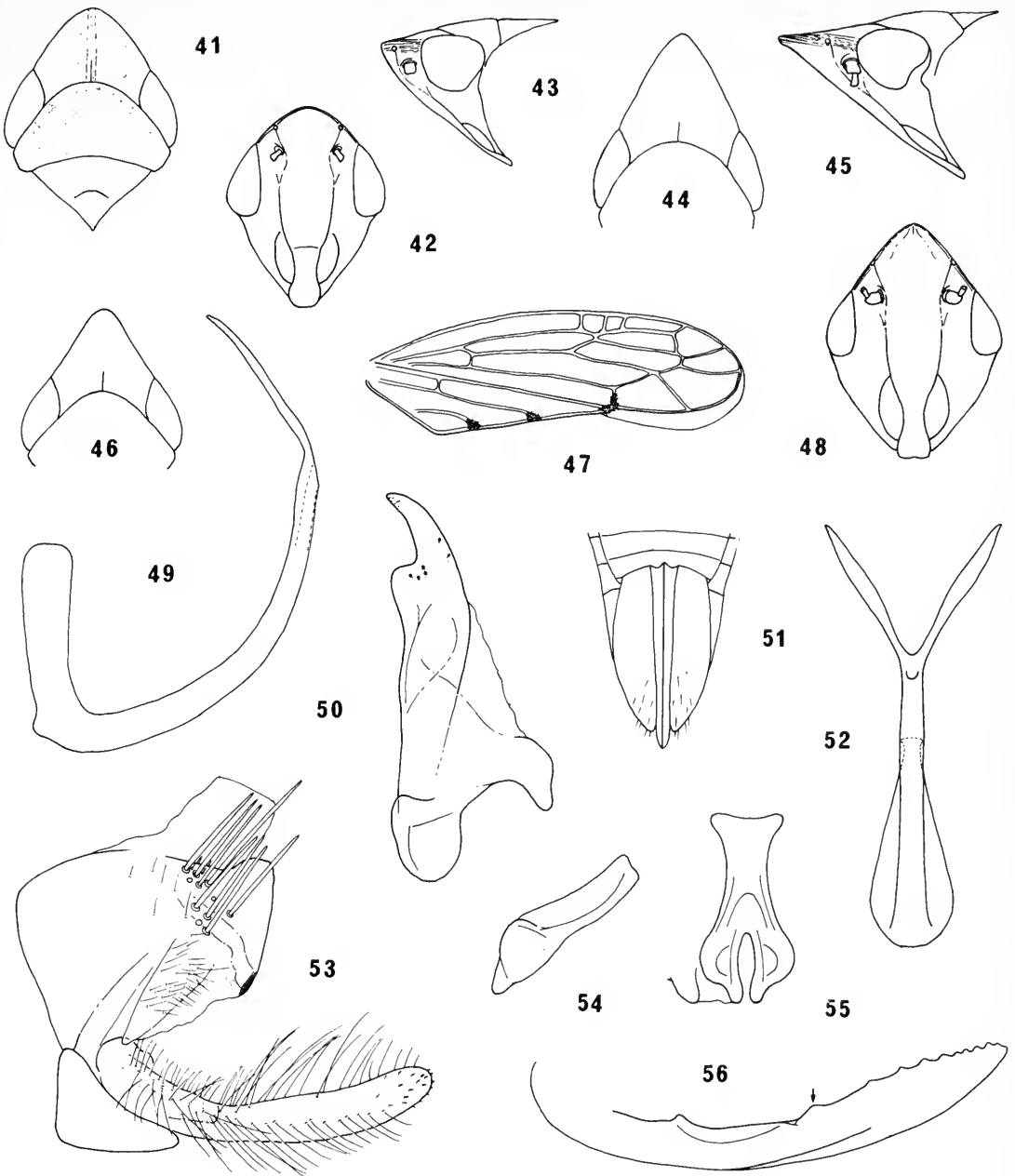

**Figs 41–56** *Dryadomorpha pallida*. 41, head and thorax, dorsal view; 42, face; 43, head and thorax, lateral view; 44, head and pronotum, dorsal view; 45, head and thorax, lateral view; 46, head and pronotum, dorsal view; 47, fore wing; 48, face; 49, aedeagus, lateral view; 50, left style, ventral view; 51, apex of ♀ abdomen, ventral view; 52, aedeagus, posterior view; 53, ♂ genital capsule, lateral view; 54, 55, connective, lateral and dorsal views; 56, second valvulae, lateral view.

*Yakunopona yakushimensis* Ishihara, 1954: 13. Holotype ♀, JAPAN (ELKU, Fukuoka) [examined]. **Syn. n.**  
*Platymetopius australis* Evans, 1966: 247. Holotype ♂, AUSTRALIA (ANIC, Canberra) [examined]. **Syn. n.**

Length: ♂, 4.5–5.6 mm, mean 5.1 mm; ♀, 5.3–6.6 mm, mean, 6.0 mm.

Colour as in generic description with rostrum and sometimes apex of clypellus scarlet; head and thorax rarely with testaceous marking (see 'Remarks' below), sometimes marked with stramineous or orange at apex of vertex and on each side at base of vertex, on lateral margins of clypeus and on anterior region of pronotum. Fore wing variably tinged with brown distally; apex of both clavus and claval veins with a small brown spot.

External characters as in generic description with vertex short to long, medial length 1.7–3.5 times length next to eyes; apex acute, narrowly rounded or fairly broadly angularly rounded, sides concave to slightly convex (see 'Remarks' below).

Male genitalia as in generic description with pygophore variable in shape (see 'Remarks' below). Style with apical process evenly tapered to acute apex, lateral lobe fairly strongly developed. Connective short. Aedeagus with shaft slender, apical processes slightly expanded at mid length, strongly divergent.

Female genitalia as in generic description.

**REMARKS.** Some specimens from India have the markings on the head and pronotum orange (see description) while one specimen from Australia has the head and thorax with testaceous markings. Considerable variation occurs in the shape of the head; usually the side margins of the vertex are nearly straight but a few specimens from India have the side margins considerably concave (Fig. 46). The face in profile is usually slightly convex to nearly straight but in one specimen from Australia the face is strongly concave. In the male genitalia slight variation occurs in the pygophore in the shape of the posterior lobes, the distal darkly pigmented region of the internal ledge and in the number of macrosetae (compare Fig. 53 from Java with Webb, 1980: 849, fig. 115 from Aldabra).

**DISTRIBUTION.** Afrotropical, southern Palaearctic and Oriental regions as far south as Singapore and Java (excluding Malaya and Sumatra) and from northern and north-eastern Australia.

#### MATERIAL EXAMINED

*Dryadomorpha pallida* Kirkaldy, holotype ♀, **Australia**: Queensland, Bundaberg, ix–xii.1904 (*Koebele*) (BPBM, Honolulu). *Paganalia virescens* Distant, lectotype ♀, **Seychelles**: Silhouette, 1908 (BMNH, London). *Zizyphoides indicus* Distant, lectotype ♀, **India**: Calcutta, on *Zizyphus jujuba* Miller, 23.vii.1912 (BMNH, London). *Rhombopsis virens* Haupt, lectotype ♂, **Israel**: 'Palestine', Ben-Shemen, 17–18.x.1925 (HJM, Jena). *Rhombopsis viridis* Singh-Pruthi, lectotype ♂, **India**: Punjab, Lyallpur, x.1929 (*Rahman*) (ZSI, Calcutta). *Rhombopsis chatterjeei* Singh-Pruthi, lectotype ♂, **India**: North Salem, Uduparani, on unspiked sandel, 29.i.1930 (*Chatterjee*) (FRI, Dehra Dun). *Platymetopius antennalis* Lindberg, holotype ♂, **Cape Verde Is.**: Fogo I., supra Fte Aleixo, 19.ii.1954 (*Lindberg*) (ZMU, Helsinki). *Yakunopona yakushimensis* Ishihara, holotype ♀, **Japan**: Yakushima, Anbo, 25.viii.1952 (*Takeya & Hirashima*) (ELKU, Fukuoka). *Platymetopius australis* Evans, holotype ♂, **Australia**: NW., Kimberley Research Station, via Wyndham, 23.viii.1956 (*Langfield*) (ANIC, Canberra).

**India**: 1♂, 1♀, Punjab, Lyallpur, x.1929, 7.x.1929 (ZSI, Calcutta) (paralectotypes of *Rhombopsis viridis* Singh-Pruthi); 1♂, North Salem, Jawalagiri, 22.xii.1930 (ZSI, Calcutta) (paralectotypes of *Rhombopsis chatterjeei* Singh-Pruthi); 1♀, Coorg, 9.ii.1930 (ZSI, Calcutta) (paralectotype of *Rhombopsis chatterjeei* Singh-Pruthi); 3♂, 3♀, Delhi, Indian Agricultural Research Institute, at light; 1♂, Bihar, Pusa, 14.vi.1931; 1♂, 6♀, Ludhiana, 25.xi.1976 (all in BMNH, London). **Nepal**: 3♂, 3♀, near Simra, Abhabbar, 180 m, 25–27.viii.1967; 1♀, near Birganj, Lothor, 135 m, 3.ix.1967 (all in CNC, Ontario); 1♀, Kathmandu, 1300–1400 m, 7–12.v.1966 (BPBM, Honolulu); 2♀, Arun Valley, below Tumlingtar, river Sabhaya, west shore, 460 m, 22.xii.1961 (BMNH, London). **Sri Lanka**: 1♂, Amiradhapura, at light, 22.iii.1953 (BMNH, London). **Bangladesh**: 1♂, Lawa Chera forest, Srimangal, 110 m, 27.ix.1961 (CAS, San Francisco). **China**: 1♀, Macao, i.1907; 1♂, 3♀, Fujian, Yungan, 4.viii–24.ix.1940 (all in BPBM, Honolulu). **Japan**: 1♂, 2♀, Tokara I., Nakanoshima, 25.v.–13.vi.1953; 1♂, Kyushu, Satamisaki, Osumi, 30.viii.1951 (all in ELKU, Fukuoka). **Hong Kong**: 1♂, Lantau I., Shek Pik Reservoir area, 21.vii.1964; numerous examples, Sai Kung Station, 30.i.1965; 9♂, 8♀, Taipokau, 20.vi.–6.vii.1964 (all in BPBM, Honolulu). **Taiwan**: 1♂, 1♀, Taipei Hsien Santiaoling, 100–400 m, 19.xi.1957 (BPBM, Honolulu). **Thailand**: 1♀, South Banna, Nakhon, 108 m, 5–10.v.1958; 1♂, Bangkok, at light, 4.xii.1957; 1♀, Chiangmai, Fang, 12–19.iv.1958 (all in BPBM, Honolulu). **Laos**: 1♀, Vientiane, at light, 8.v.1965 (BPBM, Honolulu). **Philippines**: 2♂, 1♀, Busuanga I., 4 km north of San Nicolas, at light, 21–24.v.1962, 1♂, Palawan, 3 km north-east of Tinabog, at light, 14.v.1962; 1♀, Palawan, Tarumpitao Point, at light, 26.v.1958; 1♀, Culion I., 6 km west of Culion, at light, 7.vi.1962 (all



in BPBM, Honolulu). **Singapore:** 4 ♂, 1 ♀, Mandai, mangrove, at light (BMNH, London). **Java:** 1 ♂, Bogor, at light, v.1954 (BMNH, London). **Australia:** 1 ♀, Western Australia, Kimberley Research Station, via Wyndham, 23.viii.1956 (ANIC, Canberra) (paratype of *Platymetopius australis* Evans); 1 ♀, New South Wales, Sydney (BMNH, London).

***Dryadomorpha metrosideri* (Osborn) comb. n.**

(Figs 57–60)

*Calotettix metrosideri* Osborn, 1934: 247. Holotype ♀, MARQUESAS Is. (BPBM, Honolulu) [examined].

*Calotettix metrosideri* var. *tincta* Osborn, 1934: 248. LECTOTYPE ♀, MARQUESAS Is. (BPBM, Honolulu), here designated [examined]. **Syn. n.**

*Calotettix lais* Eyles & Linnavuori, 1974: 40. Holotype ♂, COOK Is. (IM, Auckland) [examined]. **Syn. n.**

Length: ♂, Marquesas Is., 6.3–6.7 mm, mean 6.5 mm; Cook Is., 6.8–7.4 mm, mean 7.2 mm; Australia, 5.5 mm; ♀, Marquesas Is., 7.0–7.7 mm, mean 7.2 mm; Cook Is., 7.8–8.5 mm, mean 8.1 mm.

Yellow or yellow tinged with green or orange; darker specimens with additional reddish and dark brown markings on pronotum and scutellum; some specimens (see 'Remarks' below) have face reddish, fore wings either marked with brown on inner margin of clavus and with a brown spot at base of fourth apical cell, or marked with brown bordering veins of clavus and veins *cu* and *m* and with a brown patch at apex of wing, and female pygophore with a dark brown patch posteriorly on each side.

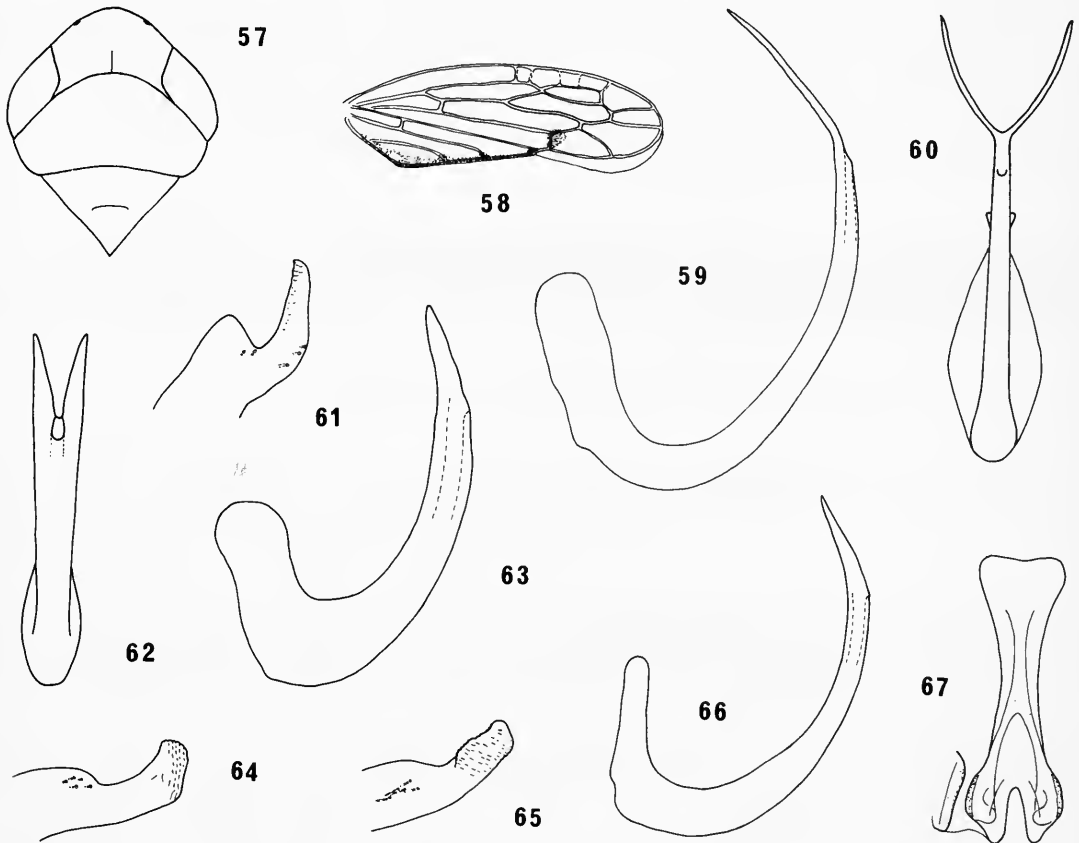

**Figs 57–67** *Dryadomorpha* species. 57–60. *D. metrosideri*. (57) head and thorax, dorsal view; (58) fore wing; (59, 60) aedeagus, lateral and posterior views. 61–63. *D. robustipennis*. (61) apex of left style, ventral view; (62, 63) aedeagus, posterior and lateral views. 64–67. *D. pacifica*. (64) apex of the left style, ventral view, Sarawak; (65) same, New Guinea; (66) aedeagus, lateral view; (67) connective, dorsal view.

External characters as in generic description with vertex short, approximately 1.5 times as long medially as next to eyes, sides slightly convex, apex fairly broadly angularly rounded.

Male genitalia as in *pallida* but aedeagal processes in posterior aspect narrow throughout length.

Female genitalia as in *pallida*.

REMARKS. In addition to the differences in size noted above specimens from different localities vary in the following ways: the single specimen from Australia has a medial longitudinal keel dorsally on the face (absent in other specimens), the clypeus reddish, some veins of the fore wing bordered with brown, and a brown patch at the apex of the fore wing; specimens from the Marquesas Is. have the inner margin of the fore wing variably marked with brown (Fig. 58) and the face sometimes marked with red, the thorax marked with red or brown and the female pygophore marked with brown posteriorly; the specimens from the Cook Is. are without markings.

This species can be distinguished from other members of the genus by its short head. The male genitalia are almost identical to those of *pallida*, differing only in the shape of the aedeagal processes as noted above.

DISTRIBUTION. Marquesas Is., Cook Is. and northern Australia.

#### MATERIAL EXAMINED

*Calotettix metrosideri* Osborn, holotype ♀, **Marquesas Is.**: Hiva Oa, Kopoa faa, miscel. sweeping, 831 m, 3.viii.1929 (*Mumford & Adamson*) (BPBM, Honolulu). *Calotettix metrosideri* var. *tincta* Osborn, lectotype ♀, **Marquesas Is.**: Hiva Oa, Feani Ridge, 1140 m, 22.i.1932 (*Le Bronnec*) (OSU, Columbus). *Calotettix lais* Eyles & Linnavuori, holotype ♂, **Cook Is.**: Rarotonga, 15.xii.1937 (IM, Auckland).

**Marquesas Is.**: numerous specimens from Hiva Oa, 630–1140 m, on *Weinmannia parviflora* G. Forster, *Reynoldsia* sp., *Glochidion ramiflorum* G. Forster or *Rapanea* sp., 1.viii–5.i.1932 (*Le Bronnec* or *Mumford & Adamson*) (paratypes of *Calotettix metrosideri* Osborn and paralectotypes of *Calotettix metrosideri* var. *tincta* Osborn) (BPBM, Honolulu; OSU, Columbus). **Cook Is.** 3 ♂, 1 ♀, Rarotonga I., Papua Creek, Vaimaanga, at light, 13.x.1975; 7 ♂, 3 ♀, Rarotonga I., Avatu Valley, at light, x.1975; 2 ♂, 1 ♀, Rarotonga I., Totokoitu Ridge, 210 m, 19.x.1975; 1 ♂, Rarotonga I., Totokoitu, at light, 14.x.1975 (all in DSIR, Auckland and BMNH, London). **Australia**: 1 ♂, Northern Territory, Darwin (JWE, Sydney).

### *Dryadomorpha viridia* Osborn

*Dryadomorpha viridia* Osborn, 1934: 244. Holotype ♀, **MARQUESAS IS.** (BPBM, Honolulu) [examined].

Length: ♀, 6.7 mm.

Colour as in generic description with inner margin of clavus brown.

External characters as in generic description with vertex moderately long, medial length approximately twice as long as length next to eyes, apex acutely rounded, sides slightly convex.

Male genitalia unknown.

Female genitalia as in generic description.

REMARKS. The single known specimen of this species is tentatively regarded as distinct from *metrosideri*, differing only in its longer head.

DISTRIBUTION. Marquesas Is.

#### MATERIAL EXAMINED

*Dryadomorpha viridia* Osborn, holotype ♀, **Marquesas Is.**: Nuku Hiva I., Toovii, 750 m, 4.viii.1931, beating *Metrosideros collina* (J. R. & G. Forster) (*Le Bronnec & Tauraa*) (BPBM, Honolulu).

### *Dryadomorpha robustipenis* sp. n.

(Figs 61–63)

Length: ♂, 5.2–6.0 mm, mean 5.5 mm; ♀, 6.0–6.3 mm, mean 6.1 mm.

Colour as in generic description with a small brown spot at apex of clavus and claval veins of forewing.

External characters as in generic description with vertex moderately long, medial length 2.5–3.0 times as long as length next to eyes, apex acutely rounded, sides slightly convex to slightly concave.

Male genitalia similar to *pallida* but connective moderately long and aedeagus more robust with apical processes shorter and only slightly divergent.

Female genitalia as in generic description.

REMARKS. This species closely resembles *pacifica* and is known to be sympatric with this species over part of its range in Sarawak and Sabah. It can be distinguished from *pacifica* in the male genitalia by the narrower apical process of the style, the more pronounced lateral lobe of the style and the more robust shaft of the aedeagus. From the similar but more northerly and southerly distributed *pallida* it differs in the male genitalia as noted above.

DISTRIBUTION. Malaya and Borneo (Sarawak, Sabah).

#### MATERIAL EXAMINED

Holotype ♂, **Sarawak**: foot of Mount Dulit, junction of rivers Tinjar and Lejok, at light, 1.x.1932 (*Hobby & Moore*) (BMNH, London).

Paratypes. **Malaya**: 1 ♂, Kuala Lumpur, Klang gates, 31.xii.1958 (*Quate*) (BPBM, Honolulu); 1 ♀, Kuala Lumpur, 13.iii.1939 (*Pendlebury*) (BMNH, London). **Borneo**: 3 ♂, 2 ♀, Sarawak, same data as holotype, 26.viii.–25.ix.1932; 1 ♂, Sarawak, Paya, Palah, at light, 4.xi.1964 (*Rothschild*) (all in BMNH, London); 1 ♂, Sarawak, Bau, lake area, 30.viii.1958 (*Maa*) (BPBM, Honolulu); 1 ♂, Sabah, Tawau, Quoin Hill, at light, 3–7.vii.1962 (*Holtman*); 1 ♂, Sabah, Tawau, Quoin Hill, Cocoa Research Station, 22.viii.1962 (*Hirashima*) (all in BPBM, Honolulu).

### *Dryadomorpha pacifica* sp. n.

(Figs 64–67)

Length: ♂, 5.2–6.5 mm, mean 5.6 mm; ♀, 5.5–6.4 mm, mean 5.9 mm.

Colour and external characters as in *robustipennis*.

Male genitalia similar to *robustipennis* but apical process of style broader apically and foot-like, or with a subapical prominence, and lateral lobe of style less pronounced and aedeagus with shaft narrower and tapered more at midlength to apex.

Female genitalia as in generic description.

REMARKS. In this species slight variation occurs in the shape of the apical process of the style and the processes of the aedeagus. In the specimens from Sarawak and Sabah the apical process of the style is foot-like and the aedeagal processes are narrow and nearly parallel, while specimens from New Guinea have the apical process of the style with a slight subapical prominence and the processes of the aedeagus stouter and more divergent. The significance of these differences cannot be ascertained at the present time.

This species closely resembles *robustipennis* and is known to be sympatric with this species over part of its range in Sarawak and Sabah. It can be distinguished from *robustipennis* in the shape of the style and aedeagus as noted above. It differs from the similar but more northerly and southerly distributed *pallida* in the longer connective and the more robust aedeagus with the apical processes shorter and only slightly divergent.

DISTRIBUTION. Borneo (Sarawak, Sabah), New Guinea and Vanuatu.

#### MATERIAL EXAMINED

Holotype ♂, **New Guinea**: Sarmi, W. to Hollandia, 20–23.vii.1959 (*Maa*) (BPBM, Honolulu).

Paratypes. **Borneo**: 1 ♂, Sarawak, Bau district, lake area, 30.viii.1958 (*Maa*) (BPBM, Honolulu); 1 ♂, Sabah, Tawau, Quoin Hill, Cocoa Research Station, primary forest, 3.x.1962 (*Hirashima*); 1 ♂, Sabah, Tawau, Quoin Hill, 3–7.vii.1962 (*Holtman*) (BPBM, Honolulu). **New Guinea**: 1 ♂, Nabire, 5–50 m, at light, 25.viii.–2.ix.1962 (*Sedlacek*); 1 ♂, mouth of river Tor, 4 km E. of Maffen, 19.vii.1959 (*Maa*); 1 ♂, Kokoda, 400 m, at light, 15–20.xi.1965 (*Sedlacek*); 1 ♀, Bodem, 100 m, 11 km SE. of Oerberfaren, at light, 7–17.vii.1959 (*Maa*) (all in BPBM, Honolulu); 15 ♂, same data as holotype (BPBM, Honolulu; BMNH, London). **Vanuatu**: 3 ♀, Espiritu Santo, Apouna river camp, 300 m, 9–12.ix.1971 (*Robinson*) (SAM, Adelaide); 1 ♂, Espiritu Santo, Narango, 90 m, vi.1960 (*Brandt*) (BPBM, Honolulu); 1 ♀, Santo I., 17.vi.1925 (*Buxton*) (BMNH, London).

***RHUTELORBUS* gen. n.**

Type-species: *Rhutelorbus merinoi* sp. n.

Yellow or greenish yellow, sometimes with paler patches on head and thorax; fore wings with a small brown spot at apex of both clavus and claval veins.

Head wider than pronotum; anterior margin acutely rounded in profile, transversely striate, becoming finely carinate and rim-like medially; ocelli on margin, distant from eyes, not visible from above; anterior tentorial branches curved anteriorly, not bifurcate. Vertex triangularly produced, medial length approximately 2.5 times length next to eyes, sides slightly convex, apex acutely rounded; with a slight longitudinal depression; finely rugose. Face elongate, shagreen; lateral margin adjacent eye visible dorsally; upper margin slightly depressed each side of mid line, forming a faintly striate longitudinal keel medially; face in profile more or less straight or concave anteriorly; clypeus elongate, lateral margins constricted near antennae; clypellus elongate, expanded apically; transclypeal suture indistinct; lora large; antennal pit deep with inner margin angularly rounded to clypeus, rim-like and nearly carinate; antennal ledge slight; antennae very long, extending to beyond apex of clavus. Pronotum approximately twice as wide as long, side margins very short, without a carina; finely transversely rugose. Scutellum approximately equal in length to

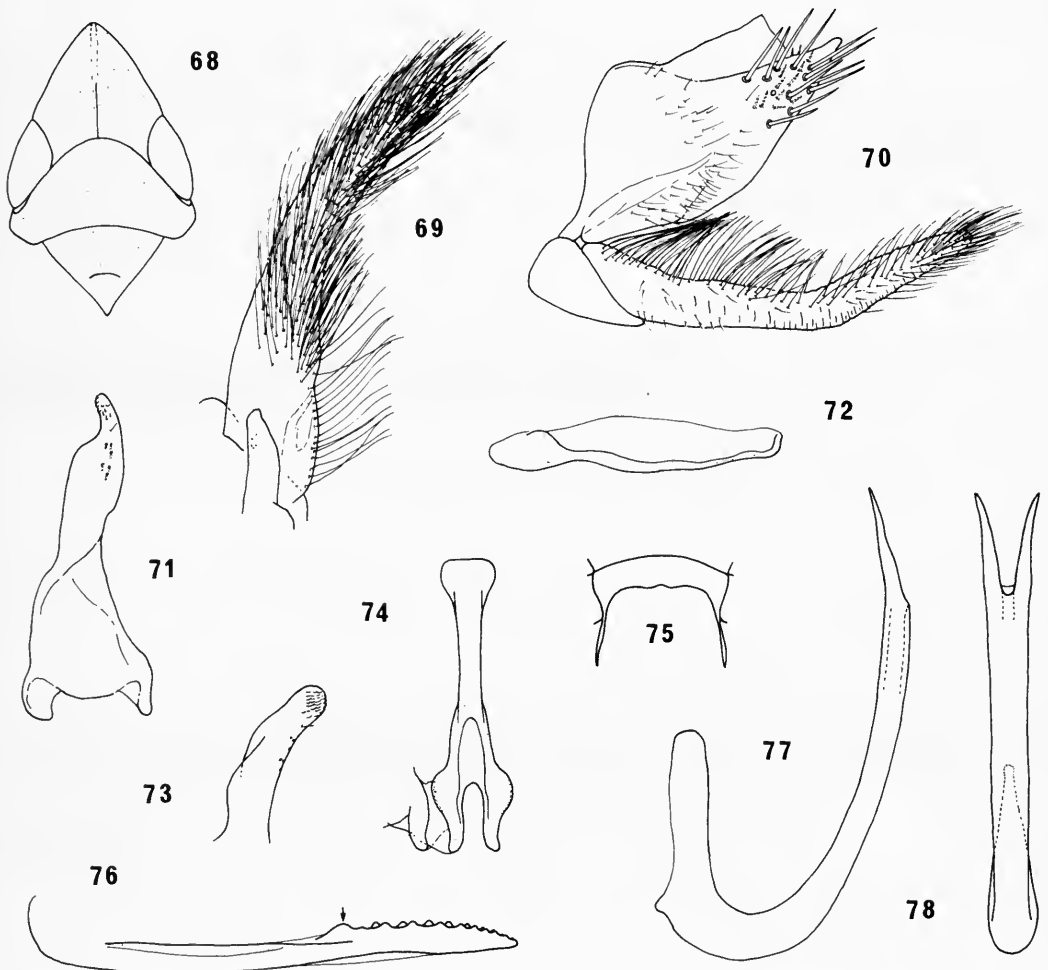

**Figs 68–78** *Rhutelorbus merinoi*. 68, head and thorax, dorsal view; 69, left subgenital plate and apex of left style, dorsal view; 70, ♂ genital capsule, lateral view; 71, left style, ventral view; 72, connective, lateral view; 73, apex of left style, lateroventral view; 74, connective, dorsal view; 75, ♀ pregenital sternite, ventral view; 76, second valvulae, lateral view; 77, 78, aedeagus, lateral and posterior views.

pronotum, shagreen, obscurely rugose posteriorly. Fore wing with three subapical cells, first subapical open, second and third subapicals closed; one or two additional veinlets in subcostal region near to fifth apical cell. Fore tibia with dorsal setal arrangement 1 : 4; fore femur with a series of two or three fine setae distally on anterior surface; hind femur with apical setal formula 2 + 1 + 1 with first proximal seta slender.

Apodemes of male third abdominal segment ventral, reduced.

Male genitalia with anterior margin of pygophore straight dorsally, without apodemes; pygophore lobes with several macrosetae and short fine setae. Xth segment moderately long, compressed dorsoventrally. Subgenital plate elongate, triangular with numerous moderate to long fine setae dorsally and several short to moderately long fine setae ventrally. Valve triangular. Style moderately long, narrow, with lateral lobe and basal apophyses prominent; apical process fairly short, curved ventrally, tapered to apex, crenulate apically; few sensory papilla and a single seta adjacent lateral lobe. Connective Y-shaped, stem elongate with lateral margins keel-like dorsally; arms short. Aedeagus with shaft elongate, curved dorsally with a pair of apical, dorsally directed processes; gonopore small, situated at apex; basal apodeme moderately long, narrow.

Female genitalia with posterior margin of pregenital sternite extended posteriorly; second valvulae united at first dorsal tooth (arrowed in Fig. 76), elongate, very slightly expanded distally; without a basal prominence; dorsal teeth robust, unaligned, extending over approximately distal third of valvulae.

REMARKS. This genus is similar externally to *Dryadomorpha* and some species of *Parohinka* but can be distinguished from these and other genera of the subfamily by the rugose vertex and pronotum, the lateral margins of the face adjacent to the eyes being visible dorsally, and by the extended posterior corners of the pregenital sternite (also present in some species of *Parohinka*).

DISTRIBUTION. Philippines, Malaya and Borneo (Sarawak).

### *Rhutelorbus merinoi* sp. n.

(Figs 68–78)

Length: ♂, 5.6–6.5 mm, mean, 6.0 mm; ♀, 6.2–7.4 mm, mean 6.8 mm.

Colour and external characters as in generic description.

Male genitalia as in generic description with pygophore lobes acutely produced posteriorly and aedeagus with shaft narrow, slightly tapered from base to apex with apical processes fairly short (see 'Remarks' below).

Female genitalia with posterior margin of pregenital sternite extended posteriorly, maximum length as in Fig. 75, sometimes one-third this length.

REMARKS. The male specimen from the Philippines has the apical process of the style curved more ventrally and the apical processes of the aedeagus shorter than in other specimens.

DISTRIBUTION. Philippines, Malaya and Borneo (Sarawak).

#### MATERIAL EXAMINED

Holotype ♂, **Malaya**: Kuala Lumpur, at light, 16.x.1928 (*Corbett*) (BMNH, London).

Paratypes. **Philippines**: 1 ♀, Tawi Tawi, Lapid Lapid at Manalik Channel, at light, 19.xi.1961; 1 ♂, Tawi Tawi, Tarawakan, north of Batu Batu, at light, 13.xi.1961 (both in ZM, Copenhagen). **Malaya**: 1 ♀, Kuala Lumpur, at light, 18.i.1931 (*Pendlebury*) (BMNH, London); 2 ♂, 2 ♀, Kuala Lumpur, 24–31.xii.1958 (*Quate*); 4 ♂, 1 ♀, Kuala Lumpur, Klang gates, 31.xii.1958 (*Quate*); 1 ♀, Kuala Lumpur, 19 km south of Subang, 23.xii.1958 (*Quate*); 7 ♂, Kuala Tahan, 15–16.xii.1958 (*Quate*) (all in BPBM, Honolulu); 1 ♂, Selangor, at light, 19.iv.1932 (*Pendlebury*) (BMNH, London). **Borneo**: 1 ♂, no locality, 1898 (*Noualhier*) (MNHN, Paris); 1 ♂, Sarawak, foot of Mount Dulit, junction of R. Tinjar and Lejok, old secondary forest, at light, 29.viii.1932 (*Hobby & Moore*) (BMNH, London); 1 ♀, Sarawak, Bau District, Bidi, 19–240 m, at light, 2.iv.1958 (*Maa*); 1 ♀, Sarawak, Kuching, Santubong, 797–1500 m, 18–30.vi.1958 (*Maa*) (both in BPBM, Honolulu).

### *PAROHINKA* gen. n.

Type-species: *Muirella longiseta* Melichar, 1914.

Yellow, greenish yellow or brownish yellow; head with yellow or whitish yellow patches, usually mottled with brown. Fore wings with a small brown spot at apex of both clavus and claval veins, often faint. Legs spotted with brown.

Head wider than pronotum; anterior margin angularly rounded in profile, transversely striate laterally, becoming finely carinate and usually rim-like medially, ocelli on margin distant from eyes, not visible from above; anterior tentorial branches curved anteriorly, not bifurcate. Vertex triangularly produced, medial length 1.5–4.0 times length next to eyes, sides slightly convex to slightly insinuate in longer-headed forms, apex acute to broadly angularly rounded; with a medial longitudinal depression; finely longitudinally striate, transversely striate anteriorly. Face elongate to only slightly longer than wide, shagreen; upper margin usually slightly depressed each side of mid line, forming a faintly striate longitudinal keel medially, indistinct in shorter-headed forms; face in profile convex to concave in longer-headed forms; clypeus elongate, lateral margins constricted near antennae; clypellus elongate, expanded apically; transclypeal suture distinct or indistinct; lora large; antennal pit deep with inner margin angularly rounded to clypeus and sometimes faintly rim-like and nearly carinate; antennal ledge absent; antennae very long, when recurved extending beyond apex of clavus. Pronotum approximately twice as wide as long, side margins very short, without a carina; finely and irregularly transversely striate, obscurely rugose anteriorly. Scutellum approximately equal in length to pronotum, shagreen with posterior region obscurely rugose. Fore wings with three subapical cells, first subapical cell open, second and third subapical cells closed; with a few additional veinlets in subcostal region near to fifth apical cell. Fore tibia with dorsal setal arrangement 1 : 4; fore femur with a series of seven setae distally on anterior surface; hind femora with apical setal formula 2 + 1 + 1 with first proximal seta slender.

Apodemes of male third abdominal segment ventral, reduced.

Male genitalia with posterior margin of pygophore straight dorsally, without apodemes; pygophore lobes with a slight oblique internal ledge, usually not attaining posterior margin; posterior margin sometimes serrate and sometimes extended spine-like dorsally; lobes with several macrosetae and numerous short to moderately long fine setae. Xth segment moderate to long, compressed dorsoventrally, narrowing basally in lateral aspect. Valve triangular. Subgenital plate elongate, triangular with basal lobe relatively short and prominent; outer margin with numerous long to very long fine setae on dorsal and ventral surfaces; apex with few very short stout setae. Style short with basal apophyses indistinct; apical process short to moderately long, curved ventrally, tapered to apex or spatulate, ventral surface crenulate; lateral lobe prominent; few sensory papilla ventrally adjacent lateral lobe. Connective Y-shaped, stem moderate to very long, narrow, with lateral margins keel-like dorsally; arms short. Aedeagus assymetrical; shaft elongate, curved dorsally, sometimes recurved ventrally at apex, either of similar width throughout length, tapered to apex or expanded distally in lateral aspect, sometimes compressed anteroposteriorly; with from one to three processes distally; sometimes with an apical membranous region adjacent to gonopore; gonopore small, situated at or near apex on left or right lateral surface within a species or on posterior surface; basal apodeme short to moderately long, compressed laterally or anteroposteriorly.

Female genitalia with posterior margin of pregenital sternite either broadly V-shaped medially or with posterior corners extended posteriorly. Second valvulae united at or before first dorsal tooth (arrowed in Figs 110, 121, 133, 148), expanded distally, fairly robust, without a dorsoanterior prominence; dorsal teeth fine to robust, unaligned, extending 0.25–0.40 times distance from apex to base of valvulae; dorsal sclerotized region moderately long.

REMARKS. This genus is almost identical externally to *Dryadomorpha* but can usually be distinguished by the pale patches on the anterior margin of the head. Also similar externally to *Rhutelorbus* (see 'Remarks', p. 57). In the male genitalia the pygophore has an internal ledge as in *Dryadomorpha*, *Karoseefa* and *Oceanopona*, but the assymetrical aedeagus is not found in any other genus of the subfamily. In the female genitalia the extended posterior corners of the pregenital sternite of some species (*dulita*-group) are as in *Rhutelorbus* and the second valvulae are as in *Rhutelorbus*, *Karoseefa* and *Oceanopona*.

On the basis of the male and female genitalia *Dryadomorpha* can be divided into two groups. The *dulita*-group (*dulita*, *brevicephala*, *philippina*, *recurva*, *apicalis*, *longiseta* and *malayensis*) differs from the *morona*-group (*morona*, *sinuata*, *trispicata*, *lotophagorum* and *spinosa*) in having the apex of the aedeagal shaft continued as a process on one side and the posterior corners of the female pregenital sternite extended posteriorly either process-like or lobe-like in *dulita*.

DISTRIBUTION. From NE. India to the Philippines and South East Asia and south to New Guinea and the Pacific islands. The *dulita*-group extends as far south as Indonesia, while the *morona*-group is found in New Guinea and eastwards to the Cook Is.

**Key to species of *Parohinka***

- Males**
- 1 Aedeagus with apex of shaft continued as a process on one side (Figs 105, 125). (Oriental region and south to Indonesia) . . . . . 6
  - Aedeagus with apex of shaft not continued as a process on one side. (New Guinea and eastwards to the Cook Is.) . . . . . 2
  - 2 Aedeagus with two processes (both lateral or one lateral and one posterior) . . . . . 3
  - Aedeagus with three processes (two lateral and one posterior) . . . . . 5
  - 3 Aedeagus with shaft in lateral aspect of similar width throughout length or narrower apically; with two lateral processes directed ventroanteriorly . . . . . 4
  - Aedeagal shaft in lateral aspect expanded apically; with one lateral process directed ventroposteriorly and one posterior process directed ventroanteriorly (Figs 93, 94) . . . . . *lotophagorum* (Kirkaldy) (p. 63)
  - 4 Aedeagal shaft in lateral aspect evenly curved from base to apex (Fig. 84) . . . . . *morona* sp. n. (p. 60)
  - Aedeagal shaft in lateral aspect sinuate apically (Fig. 86) . . . . . *sinuata* sp. n. (p. 61)
  - 5 Posterior process of aedeagus short, approximately half length of lateral processes (Fig. 91) . . . . . *trispicata* sp. n. (p. 61)
  - Posterior process of aedeagus long, similar in length to lateral processes (Fig. 102) . . . . . *spinosa* sp. n. (p. 64)
  - 6 Apex of aedeagal shaft curved ventrally (Fig. 124). (Borneo (Sarawak)) . . . . . *recurva* sp. n. (p. 67)
  - Apex of aedeagal shaft curved dorsally . . . . . 7
  - 7 Aedeagus with one process . . . . . 8
  - Aedeagus with two or three processes . . . . . 9
  - 8 Connective approximately equal in length to style. (Malaya) . . . . . *malayensis* sp. n. (p. 70)
  - Connective approximately 1.5 times length of style. (NE. India to Indonesia) . . . . . *longiseta* (Melichar) (p. 68)
  - 9 Aedeagus with two processes. (Borneo (Sarawak, Sabah)) . . . . . *apicalis* sp. n. (p. 68)
  - Aedeagus with three processes . . . . . 10
  - 10 Lateral aedeagal processes short, arising from near posterior margin of shaft (Fig. 119). (Philippines) . . . . . *philippina* sp. n. (p. 66)
  - Lateral aedeagal processes moderately long, arising from near anterior margin of shaft (Fig. 107) . . . . . 11
  - 11 Aedeagal shaft in lateral aspect narrowly club-shaped (Fig. 107). (Borneo (Sarawak)) . . . . . *dulita* sp. n. (p. 64)
  - Aedeagal shaft in lateral aspect of similar width throughout length (Fig. 115). (Borneo (Sarawak, Sabah)) . . . . . *brevicephala* sp. n. (p. 66)

**Females**

The following key is incomplete because females of *morona*, *sinuata* and *trispicata* are indistinguishable (grouped together under couplet 2) and *spinosa* and *recurva* are known only from the male.

- 1 Posterior corners of pregenital sternite extended posteriorly, process-like or lobe-like. (Oriental region as far south as Indonesia) . . . . . 3
- Posterior corners of pregenital sternite not extended posteriorly as above. (New Guinea and eastwards to the Cook Is.) . . . . . 2
- 2 Posterior margin of pregenital sternite oblique and nearly straight each side of mid line (Fig. 83) . . . . . *morona* sp. n. (p. 60), *sinuata* sp. n. (p. 61), *trispicata* sp. n. (p. 61)
- Posterior margin of pregenital sternite angled at mid length each side of mid line (Figs 96, 97) . . . . . *lotophagorum* (Kirkaldy) (p. 63)
- 3 Posterior corners of pregenital sternite extended process-like . . . . . 4
- Posterior corners of pregenital sternite lobe-like (Fig. 109) . . . . . *dulita* sp. n. (p. 64)
- 4 Vertex with medial length 0.5–0.9 times basal width between eyes . . . . . 5
- Vertex with medial length 1.0–1.2 times basal width between eyes . . . . . 6
- 5 Vertex with medial length 0.5 times basal width between eyes. Extended posterior corners of pregenital sternite short (Fig. 118). (Borneo (Sarawak)) . . . . . *brevicephala* sp. n. (p. 66)
- Vertex with medial length 0.5–0.9 times basal width between eyes. Extended posterior corners of pregenital sternite long (Fig. 139). (NE. India to Indonesia) . . . . . *longiseta* (Melichar) (p. 68)
- 6 Pale to greenish yellow. Second valvulae fairly broad (Fig. 121). (Philippines) . . . . . *philippina* sp. n. (p. 66)
- Sordid to brownish yellow. Second valvulae narrow (Fig. 148). (Malaya) . . . . . *malayensis* sp. n. (p. 70)

*Parohinka morona* sp. n.

(Figs 79–85)

Length: ♂, 5.9–6.3 mm, mean 6.1 mm; ♀, 6.6 mm.

Pale to greenish yellow. Vertex, dorsal region of face and sometimes medial region of pronotum mottled with brown. Inner margin of fore wing sometimes tinged with brown (see 'Remarks' below); other markings as in generic description.

External characters as in generic description with vertex long, medial length 2.8–3.5 times length next to eyes and 1.0–1.2 times basal width between eyes. Face longer than wide with upper medial keel present; clypeus elongate.

Male genitalia as in generic description with pygophore moderately long. Xth segment extending to or slightly beyond posterior margin of pygophore. Connective moderately long (as in *malayensis*, Fig. 145). Style with apical process digitate, apex of process truncate in medial aspect. Aedeagus with shaft in lateral aspect tapered gradually from base to apex and terminating in a pair of ventroanteriorly directed processes; shaft sinuate in posterior aspect; gonopore situated laterally immediately below apical processes.

Female genitalia with posterior margin of pregenital sternite shallowly V-shaped (see 'Remarks' below); second valvulae united at first dorsal tooth; teeth robust, extending to approximately 0.4 times distance from apex to base of valvulae (as in *longiseta*, Fig. 133).

REMARKS. Some of the specimens examined of this species have a brown medial longitudinal band dorsally, from the head to the apex of the fore wings.

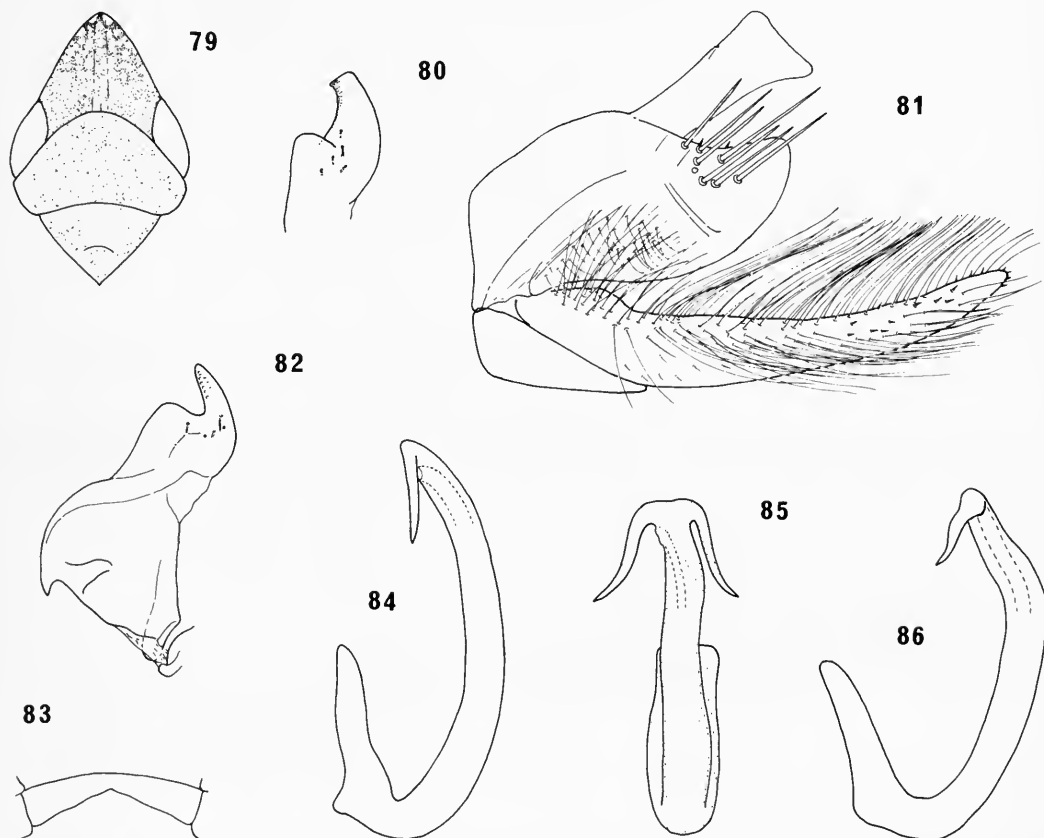

Figs 79–86 *Parohinka* species. 79–85. *P. morona*. (79) head and thorax, dorsal view; (80) apex of left style, ventromedial view; (81) ♂ genital capsule, lateral view; (82) left style, ventral view; (83) ♀ pregenital sternite, ventral view; (84, 85) aedeagus, lateral and posterior views. 86. *P. sinuata*, aedeagus, lateral view.



The following four species and *morona* form a distinct group based on distribution (New Guinea and east to the Cook Is.) and also on the shape of the male and female genitalia (see 'Remarks' under generic description, p. 58). On external appearance and in the female genitalia *morona* is identical to *trispicata* and *sinuata*. Females of the three species are therefore included in their respective type-series as they were taken at the same localities as the males therein and there being no sympatry between the males of the three species samples. Only slight differences in the shape of the pregenital sternite distinguishes females of *morona*, *sinuata* and *trispicata* from *lotophagorum*; in the first three species the posterior margin of the pregenital sternite is oblique and almost straight each side of the mid line while in *lotophagorum* it is angled at mid length each side of the mid line. In external appearance *morona* is similar to *spinosa* and is sympatric with this species over part of its range in Papua New Guinea. Females of *spinosa* are unknown. In the male genitalia *morona* differs from the above four species in having the posterior margin of the pygophore non-serrate, the aedeagus with two apical processes and the aedeagal shaft evenly curved from base to apex in lateral aspect.

**DISTRIBUTION.** New Guinea (Irian Jaya, Papua New Guinea).

**MATERIAL EXAMINED**

Holotype ♂, **New Guinea:** Irian Jaya, Cyclops Mts, Sabron, camp 2, 660 m, vii.1936 (*Cheesman*) (BMNH; London)

Paratypes. **New Guinea:** 1 ♂, 1 ♀, Irian Jaya, Torricelli Mts, Mokai Vill., 750 m, 8–15.xii.1958 (*Brandt*); 2 ♂, I.J., 40 km north of Baliem Val., 1300 m, at light, 5–11.xi.1961 (*Quate*); 1 ♂, Papua New Guinea, Swart Val., Karubaka, 1450 m, 17.xi.1958 (*Gressitt*) (all in BPBM, Honolulu).

***Parohinka sinuata* sp. n.**

(Fig. 86)

Length: ♂, 6.2–6.6 mm, mean 6.4 mm; ♀, 7.5 mm.

Colour and external characters as in *morona* with medial length of vertex 2.7–3.0 times length next to eyes and 0.8–1.1 times basal width between eyes.

Male genitalia as in *morona* but aedeagal shaft apically with processes slightly shorter.

Female genitalia as in *morona*.

**REMARKS.** This species is closely related to *morona* differing only in the shape of the aedeagus as noted above (see also 'Remarks' under *morona*, p. 60).

**DISTRIBUTION.** New Guinea (Papua New Guinea)

**MATERIAL EXAMINED**

Holotype ♂, **New Guinea:** Papua New Guinea, Lae, Singuawa R., 147° 10' E, 6° 45' S, 30 m, at light, Kunai grass, 8.iv.1966 (*Wilkes*) (BPBM, Honolulu).

Paratypes. **New Guinea:** 1 ♂, 1 ♀, same data as holotype (BMNH, London; BPBM, Honolulu); 1 ♂, P.N.G., Wau, Morobe District, 1250 m, 23.i.1963 (*Sedlacek*) (BPBM, Honolulu).

***Parohinka trispicata* sp. n.**

(Figs 87–91)

Length: ♂, 5.6–6.0 mm, mean 5.8 mm; ♀, 6.4–7.0 mm, mean 6.7 mm.

Colour and external characters as in *morona* with medial length of vertex 2.5–3.0 times length next to eyes and approximately equal to basal width between eyes.

Male genitalia similar to *morona* but apex of aedeagus with a small additional process on one side adjacent to gonopore.

Female genitalia as in *morona*.

**REMARKS.** This species is identical externally and in the female genitalia to *morona* and *sinuata* (see 'Remarks' under *morona*, p. 60). In the male genitalia it differs from *morona* and *sinuata* in having three processes on the aedeagus.

**DISTRIBUTION.** New Guinea (Irian Jaya, Papua New Guinea) and Solomon Is.

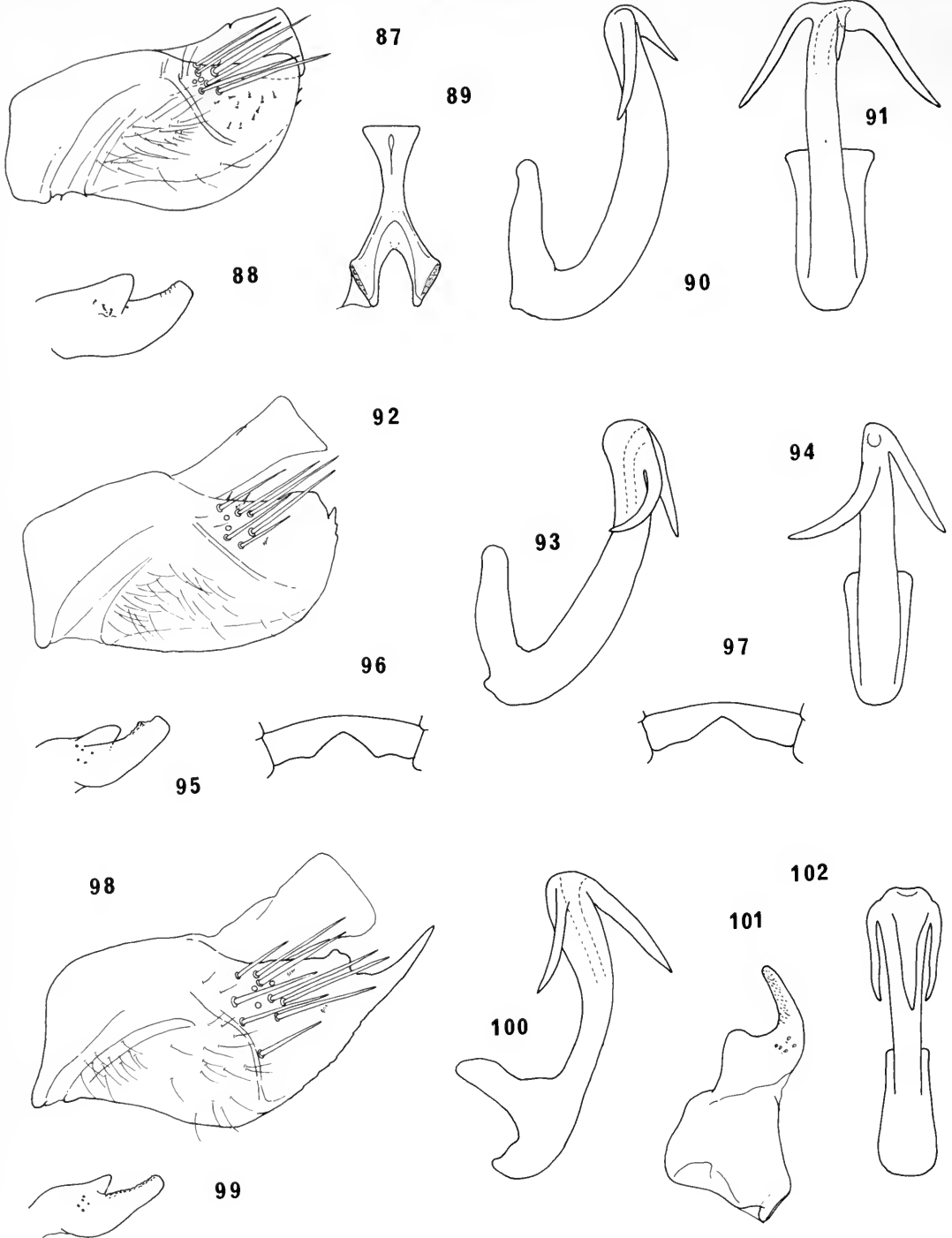

**Figs 87–102** *Parohinka* species. 87–91. *P. trispicata*. (87) ♂ pygophore and Xth segment, lateral view; (88) apex of style, ventromedial view; (89) connective, dorsal view; (90, 91) aedeagus, lateral and posterior views; 92–97. *P. lotophagorum*. (92) ♂ pygophore and Xth segment, lateral view; (93, 94) aedeagus, lateral and posterior views; (95) apex of left style, ventromedial view; (96, 97) ♀ pregenital sternite, ventral view; 98–102. *P. spinosa*. (98) ♂ pygophore and Xth segment, lateral view; (99) apex of left style, ventromedial view; (100) aedeagus, lateral view; (101) left style, ventral view; (102) aedeagus, posterior view.

## MATERIAL EXAMINED

Holotype ♂, **Solomon Is.:** Kolombangara, Pepele, 30 m, 6.ii.1964 (*Shanahan*) (BPBM, Honolulu)

Paratypes. **New Guinea:** 1 ♂, Irian Jaya, 10.xi.1944 (*Aarons*) (CAS, San Francisco); 3 ♂, 1 ♀, I.J., Hollandia, Binnen, 100 m, at light, 31.x.1958 (*Gressitt*); 1 ♀, I.J., Hollandia, at light, 28.ii.1960 (*Maa*); 1 ♂, Papua New Guinea, Adelbert Mts, Wanuma, 800–1000 m, at light, 27.x.1958 (*Gressitt*) (all in BPBM, Honolulu). **Solomon Is.:** 10 ♂, 4 ♀, Kolombangara, Pepele, 30 m, 6, 10, 15.ii.1964 (*Shanahan*) (BPBM, Honolulu; BMNH, London)

*Parohinka lotophagorum* (Kirkaldy) comb. n.

(Figs 92-97)

*Dryadomorpha lotophagorum* Kirkaldy, 1907: 41. 1 ♂, 1 ♀ syntypes, FIJI: Viti Levu, Ruwa, iii–vi (*Muir*) (lost). NEOTYPE ♂, FIJI (BPBM, Honolulu), here designated [examined].

Length: ♂, 5.4–6.5 mm, mean 6.0 mm; ♀, 6.6–7.6 mm, mean 7.0 mm.

Pale to greenish yellow. Vertex and dorsal region of face mottled with brown. Fore wings sometimes tinged with pinkish orange. Other markings as in generic description.

External characters as in *morona* with medial length of vertex 2.4–3.0 times length next to eyes.

Male genitalia similar to *morona* but posterior margin of pygophore serrate and apical process of style with a subapical prominence in medial aspect. Aedeagus with shaft tapered from base to near apex and expanded slightly at apex in lateral aspect; a more or less straight process arising at apex on one side, directed ventrolaterally and another process arising on opposite side to first and slightly below apex, strongly curved ventrolaterally; gonopore apical on posterior surface.

Female genitalia with posterior margin of pregenital sternite V-shaped medially; second valvulae as in *morona*.

REMARKS. The type-series of *lotophagorum* was listed as missing at the time when the Hawaiian Sugar Planters' Association collection was transferred to the Bishop Museum and is presumed lost. The specimens described above fit the original description almost exactly, only the darker brown spots on the lateral margins of the clypeus, mentioned by Kirkaldy, are not clear.

In external appearance this species is similar to *morona*, *sinuata*, *trispicata* and *spinosa* and is sympatric with *trispicata* over part of its range in the Solomon Is. In the female the pregenital sternite is slightly different in shape to that of *morona*, *sinuata* and *trispicata* (see 'Remarks' under *morona*, p. 60), and in the male genitalia both this species and *spinosa* can be distinguished from other members of the genus by the serrate posterior margin of the pygophore. From *spinosa* it differs in the male genitalia having the posterior margin of the pygophore without a spine-like process, the style with the apical process more robust with a preapical prominence, and the aedeagus with two processes.

DISTRIBUTION. New Guinea (Irian Jaya, Papua New Guinea), Solomon Is., Vanuatu, Fiji and Niue Is.

## MATERIAL EXAMINED

*Dryadomorpha lotophagorum* Kirkaldy, neotype ♂, Fiji: Lau group, Ono-i-Lau, Nukuni, 0–50 m, 24.ii.1971 (*Krauss*) (BPBM, Honolulu).

**New Guinea:** 1 ♂, 1 ♀, Irian Jaya, Waigeu, Camp Nok., 750 m, iv.v.1938 (*Cheesman*) (BMNH, London); 1 ♂, I.J., Japen I., SSE. Semberbaba, Dawai R., at light, 22.x.1962 (*Holtmann*); 2 ♂, 1 ♀, I.J., Waris, S. of Hollandia, 450–500 m, m.v. light-trap, 1–15.viii.1959 (*Maa*); 1 ♂, 2 ♀, I. J., Bodem, 100 m, 11 km SE. of Oerberfaren, m.v. light-trap, 10.vii, 16.xii.1959 (*Maa*); 3 ♂, Papua New Guinea, Kokoda, 400 m, light-trap, malaise trap, 15–20.xi.1965 (*Sedlacek*) (all in BPBM, Honolulu); 1 ♂, P.N.G., Madang Dist., Finisterre Mts, Damanti, 105 m, stn no. 46, 2–11.x.1964 (*Bacchus*) (BMNH). **Bismark Archipelago:** 4 ♂, New Britain, Gazelle Pen., Gaulim, 130 m, 140 m, at light, 23–28.x, 19–20.xi.1962 (*Sedlacek*); 1 ♂, N.B., Gazelle Pen., Mt Sinewit, 900 m, at light, 5–14.xi.1962 (*Sedlacek*) (all in BPBM, Honolulu). **Solomon Is.:** 1 ♀, 2 specimens (abdomens missing), Guadalcanal, Mt Austen, 15.viii.1966 (*Greenslade*) (BMNH, London); 2 ♂, G., 17.6 km SE. Tetere, Tathimani, light-trap, 12.v.1960 (*O'Brien*); 1 ♂, G., Kukum, 10 m, light-trap, 21.vi.1956 (*Gressitt*); 4 ♂, 5 ♀, Kolombangara, Pepele, 30 m, 6, 10, 15.ii.1964 (*Shanahan*); 2 ♂, 3 ♀, NW. Malaita, Dala, light-trap, 5–7.vi.1964 (*Straatman*); 1 ♂, San Cristobal, Wairahu R., 100 m, pressure lamp, 9–15.v.1964 (*Straatman*) (all in BPBM, Honolulu). **Vanuatu:** 1 ♂, Lamén I., 0–10 m, i.1976 (*Krauss*) BPBM, Honolulu); 1 ♂, Tanna I.,

Isokoai (Enpinana), 28.vii.1971 (*Gross*) (SAM, Adelaide). **Fiji**: 2 ♂, 1 ♀, Lau, Group, Ono-i-Lau, Nukuni, 0–50 m, 24.ii.1971 (*Krauss*) (BPBM, Honolulu). **Cook Is.**: 1 ♀, Niue I., nr Lefuka, bush area, m.v. light, 18.vi.1975 (*Maddison*) (BMNH, London); 1 ♂, Niue I., Kavara, at light, 11.vi.1975 (*Dugdale*) (DSIR, Auckland).

*Parohinka spinosa* sp. n.

(Figs 98–102)

Length: ♂, 5.8 mm.

Pale yellow with vertex and dorsal region of face mottled with brown; other markings as in generic description.

External characters as in *morona* with medial length of vertex 3.0 times length next to eyes and 1.2–1.3 times basal width between eyes.

Male genitalia similar to *lotophagorum* but posterior margin of pygophore extended into a long spine-like process dorsally and apical process of style narrower, without a preapical prominence. Aedeagus with shaft expanded from base to apex in lateral aspect, two lateral and one posterior process arising immediately below apex, directed ventrally, moderately long.

Female genitalia unknown.

**REMARKS.** In external appearance this species is similar to *morona*, *sinuata*, *trispicata* and *lotophagorum* and sympatric with *morona* in its single known locality in Papua New Guinea. In the male genitalia *spinosa* and *lotophagorum* can be distinguished from other members of the genus by the serrate posterior margin of the pygophore. From *lotophagorum* it differs in the male genitalia in the shape of the pygophore and style, as noted above, and the aedeagus with three processes.

**DISTRIBUTION.** Known only from the type-locality in New Guinea (Papua New Guinea).

**MATERIAL EXAMINED**

Holotype ♂, **New Guinea**: Papua New Guinea, Cyclops Mts, Sabron, 279 m, v.1936 (*Cheesman*) (BMNH, London)

Paratypes. **New Guinea**: 1 ♂, same data as holotype except, camp 2, 600 m; 3 ♂, same data as holotype except, vi.1936 (BMNH, London)

*Parohinka dulita* sp. n.

(Figs 103–110)

Length: ♂, 5.5–5.9 mm, mean 5.7 mm; ♀, 5.8–6.2 mm, mean 6.1 mm.

Pale, sordid or greenish yellow. Vertex and dorsal region of face mottled with pale brown; other markings as in generic description.

External characters as in *morona* but vertex moderately long, medial length 2.1 times length next to eyes and 0.8 times basal width between eyes.

Male genitalia as in generic description with pygophore moderately long and Xth segment extending slightly beyond posterior margin of pygophore. Connective moderately long, upturned apically. Style with apical process digitate. Aedeagus with shaft narrowly club-shaped in lateral aspect with a moderately long process at apex on one side, directed dorsally, and a moderately long subapical process on each side, arising against anterior margin, directed ventrally; apical region of shaft adjacent process and surrounding gonopore membranous.

Female genitalia with posterior margin of pregenital sternite broadly V-shaped medially, each posterior corner slightly produced lobe-like; second valvulae united at approximately 0.40 distance from apex to base of valvulae; teeth fine, extending to approximately 0.25 distance from apex to base of valvulae.

**REMARKS.** The following six species and *dulita* form a distinct group based on distribution (Oriental region from NE. India to Indonesia) and on the shape of the male and female genitalia (see 'Remarks' under generic description, p. 58). In the length of the vertex *dulita* is similar to some specimens of *longiseta* but differs from this and other members of the genus by the lobe-like posterior corners of the pregenital sternite and the valvulae united basad of the teeth. It is very similar to *brevicephala* in the male genitalia but differs in having the apical process of the style narrower in medial aspect and the shaft of the aedeagus narrowly club-shaped. This species is known to be sympatric with *longiseta* and *brevicephala* in Sarawak.

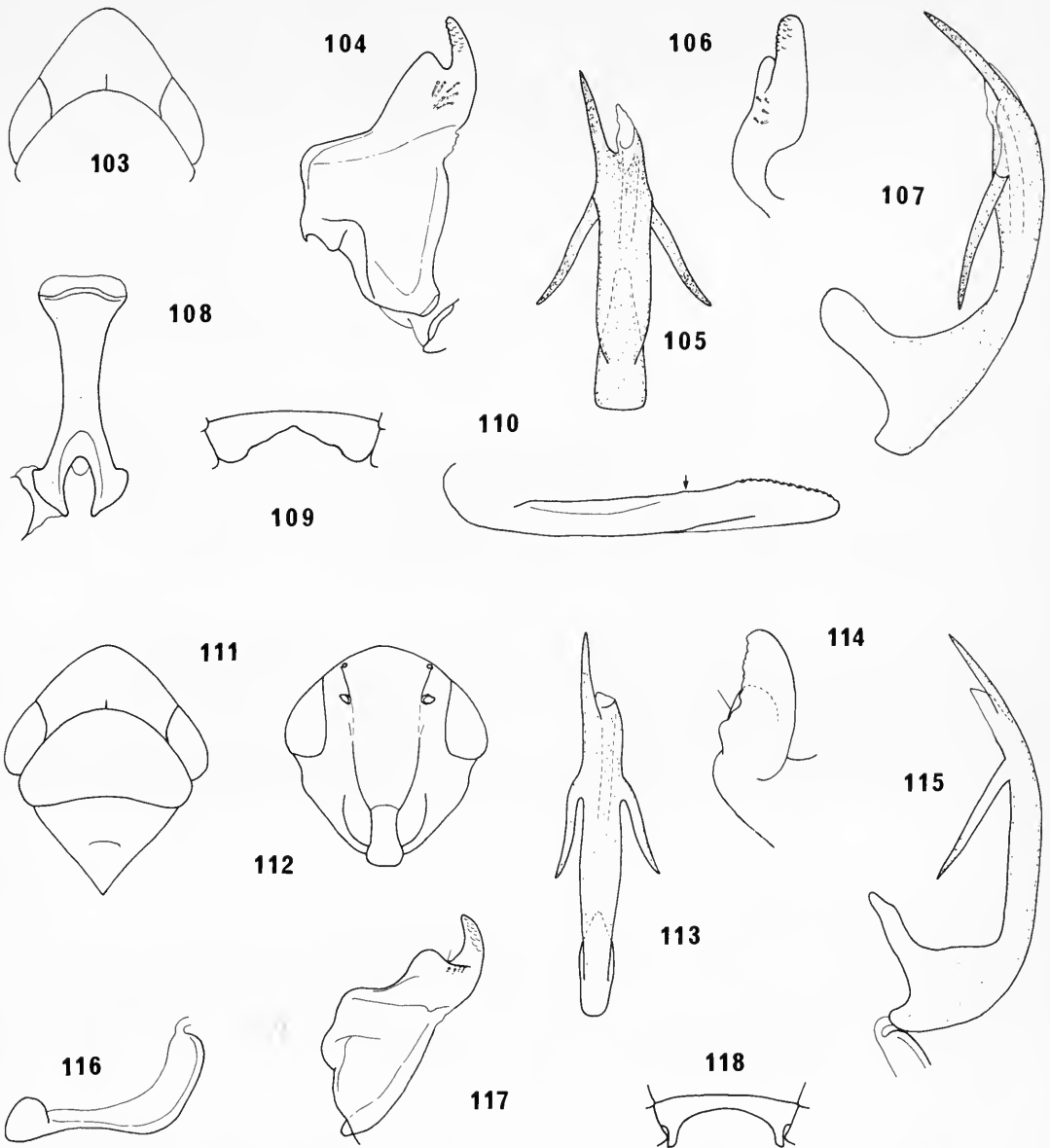

**Figs 103–118** *Parohinka* species. 103–110. *P. dulita*. (103) head and thorax, dorsal view; (104) left style, ventral view; (105) aedeagus, posterior view; (106) apex of left style, ventromedial view; (107) aedeagus, lateral view; (108) connective, dorsal view; (109) ♀ pregenital sternite; (110) second valvulae, lateral view. 111–118. *P. brevicephala*. (111) head and thorax, dorsal view; (112) face; (113) aedeagus, posterior view; (114) apex of left style, medial view; (115) aedeagus, lateral view; (116) connective, lateral view; (117) left style, ventral view; (118) ♀ pregenital sternite, ventral view.

**DISTRIBUTION.** Known only from Borneo (Sarawak, Mt Dulit).

**MATERIAL EXAMINED**

**Holotype** ♂, **Borneo:** Sarawak, foot of Mt Dulit, junction of R. Tinjar & Lejok, light-trap, 31.viii.1932 (*Hobby & Moore*) (BMNH, London)

**Paratypes. Borneo:** 2 ♀, same data as holotype, except, old secondary forest, 29.vii.1932; 1 ♀, same data as holotype except, 29.viii.1932; 1 ♂, same data as holotype except, 1.ix.1932; 1 ♀, same data as holotype except, 4.x.1932; 1 ♂, Sarawak, Mt Dulit, Dulit trail, old secondary forest, 3.ix.1932 (*Hobby & Moore*) (BMNH, London)

*Parohinka brevicephala* sp. n.

(Figs 111–118)

Length: ♂, 6.2 mm; ♀, 6.9–7.1 mm, mean 7.0 mm.

Colour as in *dulita*.

External characters as in generic description with vertex short, medial length 1.5 times length next to eyes and 0.5 times basal width between eyes. Face slightly longer than wide with upper medial keel very slight or absent; clypeus relatively short and broad.

Male genitalia similar to *dulita* but style with apical process slightly expanded in medial aspect and aedeagus with shaft of similar width throughout length in lateral aspect.

Female genitalia with posterior margin of pregenital sternite broadly U-shaped with each posterior corner extended posteriorly process-like; second valvulae as in *morona*.

REMARKS. In external appearance this species can be distinguished by its short head and relatively short and broad clypeus. It is sympatric with *dulita* and *longiseta* over part of its range in Sarawak and with *apicalis* in its single known locality in Sabah.

DISTRIBUTION. Borneo (Sarawak, Sabah).

## MATERIAL EXAMINED

Holotype ♂, **Borneo**: Sarawak, Gunong Mulu Nat. Park, Long Pala, base camp, 1978 (*Collins*) (BMNH, London)

Paratypes. **Borneo**: 6 ♂, 3 ♀, same data as holotype; 6 ♀, Sarawak, foot of Mt Dulit, junction of R. Tinjar & Lejok, light-trap/at light in house, 1, 2, 26.ix., 3, 31.x.1932 (*Hobby & Moore*) (BMNH, London); 1 ♂, Sabah, Tawau, Quoin Hill, light-trap, 3–7.vii.1962 (*Holtmann*) (BPBM, Honolulu).

*Parohinka philippina* sp. n.

(Figs 119–123)

Length: ♂, 6.6–7.3 mm, mean 7.0 mm; ♀, 8.4–8.7 mm, mean 8.6 mm.

Pale to greenish yellow. Vertex and dorsal region of face faintly mottled with brown, or markings absent. Fore wings with or without a brown spot at apex of both clavus and claval veins.

External characters as in *morona* but vertex longer, medial length 2.7–3.5 times length next to eyes and 1.0–1.1 times basal width between eyes.

Male genitalia as in *dulita* but aedeagus with shaft of similar width throughout length in lateral aspect, processes short with lateral pair directed more anteriorly.

Female genitalia similar to *brevicephala* but second valvulae broader with distance from apex of first dorsal tooth to dorsal hyaline region relatively long.

REMARKS. The elongate head of this species is similar to that found in *apicalis* and *malayensis* and slightly longer than in specimens of *longiseta* seen from the same localities in the Philippines. The male genitalia are similar to those of *dulita* and *brevicephala* but differ in the shape of the aedeagus as noted above and from *dulita* by the shorter and broader apical process of the style in medial aspect. In the female genitalia *philippina* can be distinguished by the relatively long distance from the apex of the first dorsal tooth to the dorsal hyaline region of the second valvulae.

DISTRIBUTION. Philippines (Luzon)

## MATERIAL EXAMINED

Holotype ♂, **Philippines**: Luzon, Ifugao Prov., Liwo, 8 km E. of Mayoyao, 1000–1300 m, light-trap, 1–3.vi.1967 (*Torrevillas*) (BPBM, Honolulu)

Paratypes. **Philippines**: 9 ♂, 8 ♀, same data as holotype except, 29.v.–1.vi.1967, 7,8,11,12.vi.1967; 2 ♂, Luzon, Ifugao Prov., Jacmal Bunhian, 24 km E. of Mayoyao, 800–1000 m, light-trap, 30.iv., 9–10.v.1967 (*Torrevillas*) (BPBM, Honolulu; BMNH, London).

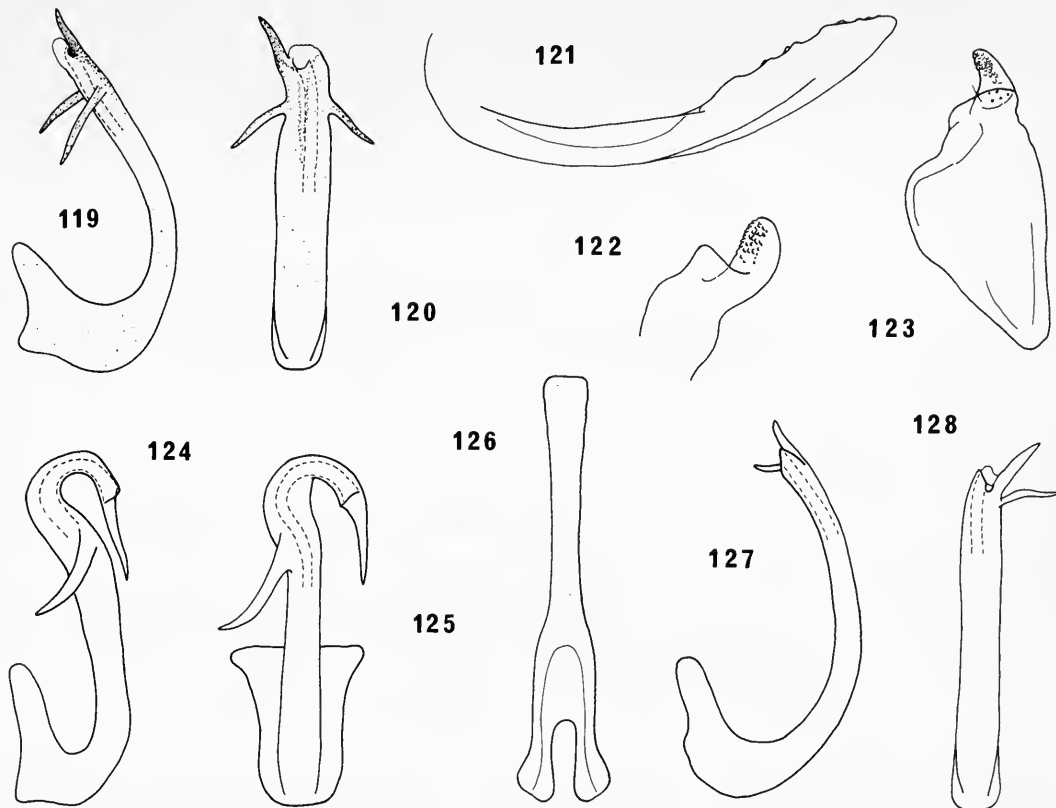

**Figs 119–128** *Parohinka* species. 119–125. *P. philippina*. (119, 120) aedeagus, lateral and posterior views; (121) second valvulae, lateral view; (122) apex of left style, ventromedial view; (123) left style, ventral view. 124, 125. *P. recurva*, aedeagus, lateral and posterior views. 126–128. *P. apicalis*. (126) connective, dorsal view; (127, 128) aedeagus, lateral and posterior views.

*Parohinka recurva* sp. n.

(Figs 124, 125)

Length: ♂, 6.6 mm.

Pale yellow. Vertex, dorsal region of face and pronotum mottled with brown; other markings as in generic description.

External characters as in *morona* but vertex longer, medial length 4.0 times length next to eyes and 1.4 times basal width between eyes.

Male genitalia similar to *dulita* with aedeagal shaft of similar width from base to near apex in lateral aspect, apical region narrower, curved laterally and ventrally and terminating in a moderately long ventrally directed process on one side; a slightly curved, anteroventrally directed process arising laterally against posterior margin slightly basad of narrow apical region of shaft; gonopore apical, adjacent to apical process.

Female genitalia unknown.

**REMARKS.** This species can be distinguished by its elongate head and ventrally curved apex of the aedeagus with one apical and one lateral process. It is sympatric with *apicalis* and *longiseta* (both with shorter heads) in its single known locality in Sarawak.

**DISTRIBUTION.** Known only from a single specimen from Borneo (Sarawak).

**MATERIAL EXAMINED**

Holotype ♂, **Borneo**: Sarawak, Kuching, Matang, 450–894 m, m.v. light-trap, 15.ix.1958 (*Gressitt & Maa*) (BPBM, Honolulu).

*Parohinka apicalis* sp. n.

(Figs 126–128)

Length: ♂, 5.6–7.1 mm, mean 6.6 mm; ♀, 8.0 mm.

Colour and external characters as in *philippina* with medial length of vertex 2.7–3.7 times length next to eyes and 1.2 times basal width between eyes.

Male genitalia with pygophore elongate, as in *longiseta* (Fig. 131). Xth segment extending to approximately level with posterior margin of pygophore. Connective very long, slightly upturned apically. Style with apical process slightly expanded. Aedeagus with shaft evenly tapered from base to apex in lateral aspect, compressed slightly anteroposteriorly with two short apical processes on one side, directed dorsally; gonopore apical, on one side, adjacent to processes.

Female genitalia unknown.

REMARKS. The elongate head of this species is similar to that of *philippina* and *malayensis* and slightly shorter than in *recurva*. In the male genitalia *apicalis* differs from *philippina* and *malayensis* in having two aedeagal processes and from *recurva* by having the apex of the aedeagus directed dorsally. Two female specimens, one from Sabah, Quoin Hill (BPBM, Honolulu) and one from Sarawak, Gunong Matang (BMNH, London) may be this species but differ slightly from one another in the shape of the genitalia.

This species is sympatric with *brevicephala* and *longiseta* (both with shorter heads) in Sabah and with *longiseta* and *recurva* in Sarawak.

DISTRIBUTION. Borneo (Sarawak, Sabah).

## MATERIAL EXAMINED

Holotype ♂, **Borneo**: Sarawak, Kuching, Matang, 450–894 m, m.v. light-trap, 15.ix.1958 (*Gressitt & Maa*) (BPBM, Honolulu).

Paratypes. **Borneo**: 1 ♂, Sarawak, Gunong Matang, 120 m, m.v. light-trap, 16.ix.1958 (*Gressitt & Maa*) (BMNH, London); 1 ♂, Sabah, Tawau, Quoin Hill, 15–20.vii.1962 (*Hirashima*) (BPBM, Honolulu).

*Parohinka longiseta* (Melichar) comb. n.

(Figs 129–143)

*Muirella longiseta* Melichar, 1914: 135. LECTOTYPE ♂, JAVA (RNH, Leiden), here designated [examined].

Length: ♂, 5.1–6.3 mm, mean 5.7 mm; ♀, 5.7–6.3 mm, mean 6.0 mm.

Pale yellow to stramineous, sometimes tinged with green. Head mottled with brown, stramineous or green, or markings absent; clypeus often patched with stramineous to reddish brown laterally. Forewings sometimes with apex and a transverse band at mid length, brown (see 'Remarks' below); other markings as in generic description.

External characters as in *morona* but vertex shorter, medial length 1.5–2.6 times length next to eyes and 0.5–0.9 times basal width between eyes. Face with upper medial keel faint in shorter-headed forms; clypeus elongate. Male genitalia as in generic description with pygophore and Xth segment elongate, the latter extending considerably beyond posterior margin of pygophore. Connective with stem elongate, slightly upturned apically. Style with apical process expanded. Aedeagus with shaft evenly curved and tapered from base to apex in lateral aspect with a single apical process directed dorsally; often apex of shaft surrounding gonoduct membranous; few faint longitudinal ridges on posterior surface of shaft and variably on apical process; gonopore apical, adjacent to apical process.

Female genitalia as in *brevipennis*, with extended posterior corners of pregenital sternite short to long.

REMARKS. This is the most widespread species of the genus and sympatric with all six other species in the *dulita*-group over parts of its range from the Philippines to Sarawak. Specimens with shorter heads are similar to *brevicephala* but have the clypeus and extended posterior corners of the pregenital sternite longer. The male genitalia are similar to *malayensis* but differing in the longer pygophore, Xth segment and connective.

In the male genitalia the apical process of the aedeagus shows some variation in shape (see Figs 136–138) and a few specimens from Malaya have the fore wings conspicuously marked with brown, as noted above; these specimens also have the markings on the head darker brown and the vertex shorter than in other specimens.



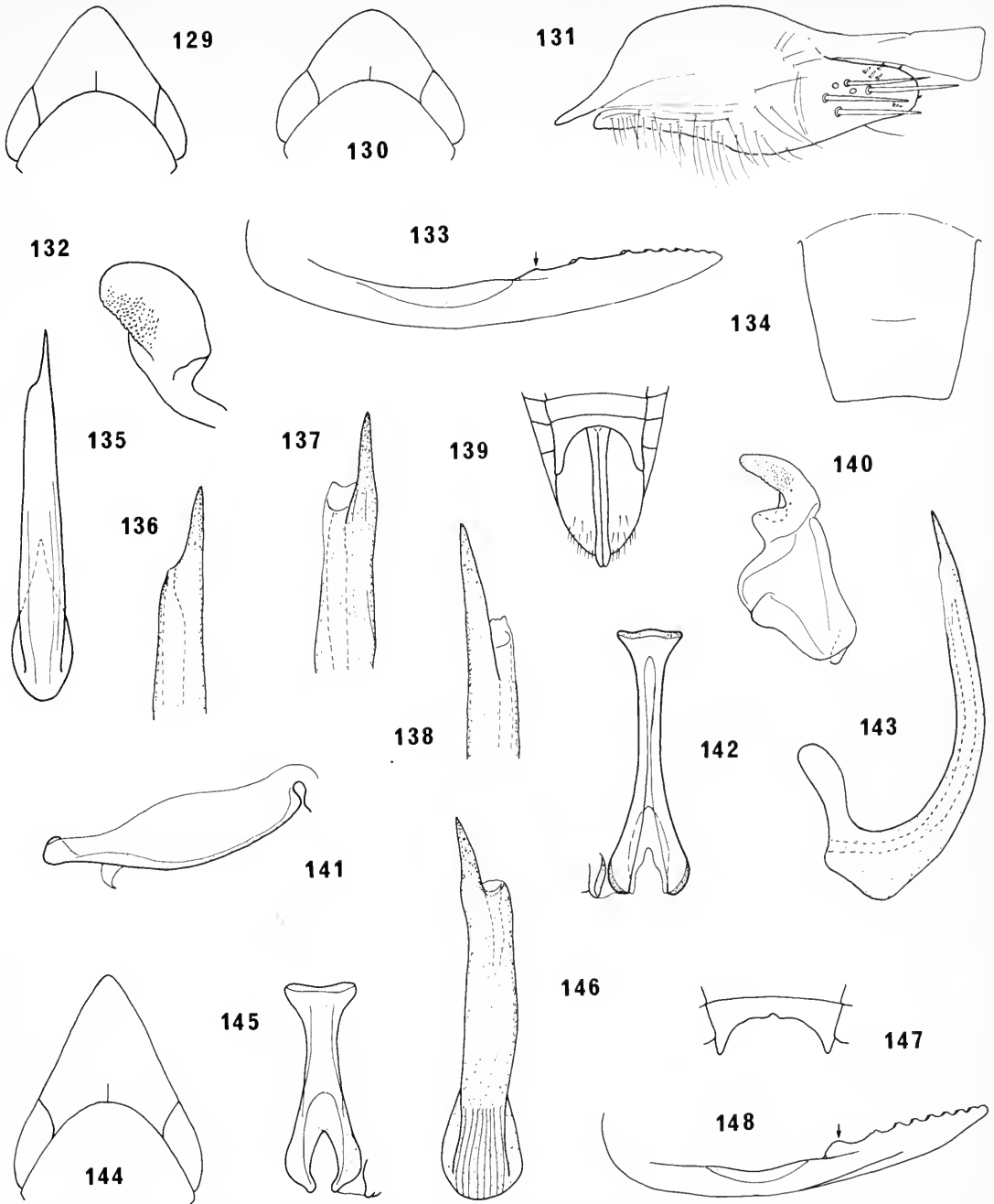

**Figs 129–148** *Parohinka* species. 129–143. *P. longiseta*. (129, 130) head and pronotum, dorsal view; (131) ♂ pygophore and Xth segment, lateral view; (132) apex of left style, medial view; (133) second valvulae, lateral view; (134) ♂ Xth segment, dorsal view; (135) aedeagus, posterior view; (136) apex of aedeagus, posterior view, Java; (137) same, Sarawak, Paya Paloh; (138) same, Malaya, Selangor; (139) apex of ♀ abdomen, ventral view; (140) left style, ventral view; (141, 142) connective, lateral and dorsal views; (143) aedeagus, lateral view. 144–148. *P. malayensis*. (144) head and pronotum, dorsal view; (145) connective, dorsal view; (146) aedeagus, posterior view; (147) ♀ pregenital sternite, ventral view; (148) second valvulae, lateral view.

DISTRIBUTION. Nepal, extreme north-east of India eastwards to the Philippines and south to Java (excluding Borneo).

MATERIAL EXAMINED

*Muirella longiseta* Melichar, lectotype ♂, **Java**: Wonosobo, v.1909 (*Jacobson*) (RNH, Leiden).

**Nepal**: 1 ♂, Adhabbar, Godavari, 1500 m, 5.viii.1967 (CNC, Ontario); 1 ♀, Kathmandu, 1300–1400 m, 7–12.v.1966 (Sedlacek) (BPBM, Honolulu). **India**: 1 ♂, W. Bengal, Darjeeling, 9.xi.1969 (*Das*) (BMNH, London). **Thailand**: 1 ♂, Chieng Mai Prov., Doisuthep, 100 m, at light, 18.vi.1965 (*Miyatake*) (ELKU, Fukuoka). **Philippines**: 17 ♂, 4 ♀, Luzon, Ifugao Prov., Liwo, 8 km E. of Mayoyao, 1000–1300 m, light-trap, 30.v–12.vi.1979 (*Torrevillas*); 1 ♂, Ifugao Prov., Jacmal Bunhian, 24 km E. of Mayoyao, 800–1000 m, light-trap, 27–29.iv.1967 (*Torrevillas*); 1 ♂, Mindanao, Mt Balatukan, 15 km SW. of Gingoog, 1000–2000 m, at light, 27–30.iv.1960 (*Torrevillas*); 1 ♀, M., Del Sur, 32 km NW. of Milbuk, 900 m, rain forest, light-trap, 6.viii.1958 (*Milliron*) (all in BPBM, Honolulu). **Malaya**: 2 ♂, 1 ♀, Gomak For. Res. near Kuala Lumpur, 28.xii.1958 (*Quate*); 1 ♂, 2 ♀, Pahang, Kuala Tahan, 15–16.xii.1958 (*Quate*); 3 ♂, 2 ♀, Kuala Lumpur, Klang gates, 31.xii.1958 (*Quate*) (all in BPBM, Honolulu); 1 specimen (abdomen missing), Kuala Lumpur, at light, 6.ii.1931 (*Pendlebury*); 3 ♀, West Coast, P. Angsa, Lt. Ho., at light, 26–27.x.1926 (*Seimund*); 1 ♂, Kedah, near Jitra, catchment area, 8.iv.1928 (*Pendlebury*); 1 ♂, Selangor, Kepong, 7.ii.1958, at light; 2 specimens (abdomens missing), Perak, G. Kledang, 795 m, 15.xi.1927 (*Seimund*) (all in BMNH, London). **Singapore**: 14 ♂, 5 ♀, Mandaj, mangrove, 7.ix.1977 (*Murphy*) (BMNH, London). **Borneo**: 1 ♂, Sarawak, Paya Paloh, at light, 4.xi.1964 (*Rothschild*); 2 ♀, Sarawak, Mt Dulit, 22 m, moss forest, light-trap, 28.x.1932 (*Hobby & Moore*); 1 ♂, Sarawak, Gunong Mulu Nat. Park (*Collins*); 1 ♂, Sarawak, Gunong Mulu Nat. Park, base camp, at light, v.1978; 1 ♀, Sarawak, Kalabit End (Mjorberg) (all in BMNH, London); 1 ♂, Sarawak, Sarikei Dist., Rejang delta, 15–25.vii.1958 (*Maa*); 1 ♂, Sarawak, Matang, m.v. light-trap, 13.ix.1958 (*Gressitt*) (both in BPBM, Honolulu); 1 ♂, Sabah, Kalabakan, light-trap, 10–19.xi.1958 (*Quate*); 1 ♂, Sabah, Kalabakan, primary forest, 11.xi.1958 (*Maa*); 1 ♀, Sabah, Tawau, Quoin Hill Cocoa Res. Sta., 20.viii.1962 (*Hirashima*); 1 ♀, Sabah, Tawau, Quoin Hill, light-trap, 15–20.vii.1962 (*Holtman*) (all in BPBM, Honolulu); 1 ♀, Sabah, R. Karamuak, 7 m SSE. Telupid, 60 m, 1–7.ix.1977 (*Bacchus*) (BMNH, London). **Java**: 1 ♂, Batavia, xi.1908 (*Jacobson*) (RNH, Leiden) (paralectotype of *Muirella longiseta* Melichar).

*Parohinka malayensis* sp. n.

(Figs 144–148)

Length: ♂, 6.2 mm; ♀, 6.9 mm.

Sordid to brownish yellow; vertex and dorsal region of face mottled with brown; other markings as in generic description.

External characters as in *morona* but vertex longer, medial length 3.2 times length next to eyes and 1.2 times basal width between eyes.

Male genitalia similar to *longiseta* but pygophore and Xth segment shorter, the latter extending only slightly beyond posterior margin of pygophore, connective with stem short rather than long and aedeagus with shaft more robust.

Female genitalia similar to *longiseta* with extended posterior corners of pregenital sternite short; second valvulae relatively narrow with first dorsal tooth large.

REMARKS. This species is closely related to *longiseta* but differs in its longer head and in the shape of the male genitalia, as noted above.

DISTRIBUTION. Known only from the type-locality in Malaya.

MATERIAL EXAMINED

Holotype ♂, **Malaya**: West Coast, P. Angsa, Lt. Ho., at light, 11.x.1926 (*Seimund*) (BMNH, London).

Paratypes. **Malaya**: 1 ♂, 1 ♀, same data as holotype except, 12/16.x. 1926 (BMNH, London).

*KAROSEEFA* gen. n.

Type-species: *Karoseefa brevipennis* sp. n.

Yellow tinged with green.

Head wider than pronotum; anterior margin rounded in profile, transversely striate; ocelli on margin distant from eyes, not or slightly visible from above; anterior tentorial branches curved anteriorly, not bifurcate. Vertex triangularly produced, medial length slightly less than twice length next to eyes; sides

slightly convex; apex moderately angularly rounded; finely longitudinally striate, transversely striate anteriorly. Face slightly wider than long, convex in profile, shagreen; clypeus relatively short and broad, lateral margins slightly constricted near antennae; clypellus moderately long, of similar width throughout length; lora large; antennal pit deep with inner margin evenly rounded to clypeus; antennal ledge slight; antennae very long, extending to near apex of clavus. Pronotum approximately twice as wide as long, sides very short, without a carina; transversely striate, obscurely rugose anteriorly. Scutellum approximately equal in length to pronotum, shagreen, obscurely rugose posteriorly. Fore wings with three subapical cells, first subapical cell open, second and third subapical cells closed; with a few additional veinlets in subcostal region near to fifth apical cell. Fore tibia with dorsal setal arrangement 1 : 4; fore femur with a series of 10 fine setae distally on anterior surface; hind femur with apical setal formula 2 + 1 + 1 with first proximal seta slender.

Apodemes of male third abdominal segment ventral, reduced.

Male genitalia with anterior margin of pygophore strongly incurved dorsally with a short apodeme on each side; pygophore lobes with an oblique internal ledge extending to posterior margin; lobes with several macrosetae and short fine setae. Xth segment fairly short, compressed dorsoventrally. Valve triangular. Subgenital plate elongate, triangular, evenly tapered to apex or with distal region digitate and lightly sclerotized; apex of basal lobe with a short acute prominence; outer margin of dorsal surface with several moderate to long fine setae; ventral surface with few short fine setae with or without numerous long fine setae along outer margin; apical region of dorsal and ventral surfaces with several short stout setae. Style moderately long with basal apophyses and lateral lobe prominent; apical process moderately long, curved ventrally and tapered to apex, crenulate dorsally or dentate ventrally; few sensory papilla dorsally, adjacent to lateral lobe. Connective Y-shaped, stem moderately long and narrow, lateral margins keel-like dorsally; arms short. Aedeagus with shaft short or long, narrow, tapered from base to apex and terminating in a pair of dorsally directed processes, gonopore small, situated apically; basal apodeme moderately long and narrow.

Female genitalia with posterior margin of pregenital sternite with one or two lobes each side of mid line; second valvulae united at first dorsal tooth (arrowed in Fig. 160), elongate, of similar width throughout length, without a basal prominence; dorsal teeth robust, unaligned, extending approximately one-quarter distance from apex to base of valvulae; dorsal sclerotized region elongate.

REMARKS. This genus can be distinguished from others of the subfamily by the broad clypeus and clypellus with sides parallel rather than concave. In the male genitalia it is similar to *Dryadomorpha* but the anterior margin of the pygophore is strongly incurved dorsally with a short apodeme on each side. The female genitalia have the second valvulae similar to those of *Parohinka* and *Rhutelorbis*.

DISTRIBUTION. Borneo (Sarawak, Sabah).

### Key to species of *Karoseefa*

- 1 Aedeagus short with apical processes more or less parallel; posterior margin of female genital sternite with two lobes each side of mid line (Fig. 161) . . . . . *brevipenis* sp. n. (p. 70)
- Aedeagus long with apical processes divergent; posterior margin of female pregenital sternite with a single lobe each side of mid line (Fig. 163) . . . . . *divergens* sp. n. (p. 73)

### *Karoseefa brevipenis* sp. n.

(Figs 149–161)

Length: ♂, 5.2–5.6 mm, mean 5.4 mm; ♀, 5.5–5.8 mm, mean 5.6 mm.

Colour and external characters as in generic description.

Male genitalia as in generic description with apex of subgenital plate digitate and lightly sclerotized, apical process of style dentate dorsally and aedeagus relatively short with processes more or less parallel.

Female genitalia with posterior margin of pregenital sternite with two lobes each side of mid line, the more lateral lobe acute.

REMARKS. I have identified only specimens of uniform colour as this species, a female specimen from Sabah: N. of Kalabakan (BPBM, Honolulu) may also be this species but has the fore wings banded with brown.

In external appearance this species is almost identical to *divergens* and is sympatric with this species over its known range in Sabah. From *divergens* it can be distinguished by its slightly

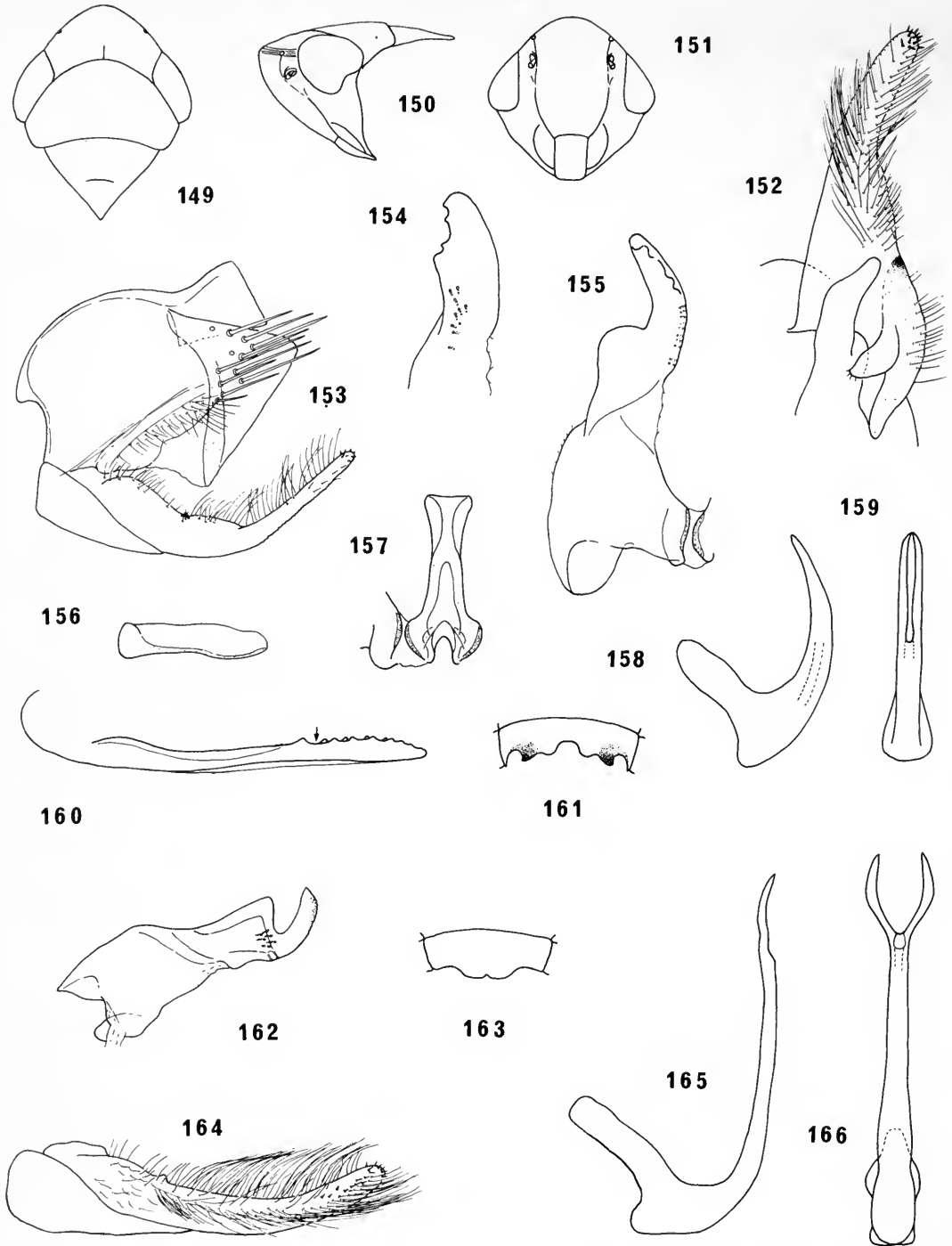

**Figs 149–166** *Karoseefa* species. 149–161. *K. brevipennis*. (149) head and thorax, dorsal view; (150) same, lateral view; (151) face; (152) left subgenital plate and apex of left style, dorsal view; (153) ♂ genitalia capsule; (154) apex of left style, medial view; (155) left style, ventral view; (156) connective, lateral view; (157) same, dorsal view. (158, 159) aedeagus, lateral and posterior views; (160) second valvulae, lateral view; (161) ♀ pregenital sternite, ventral view. 162–166. *K. divergens*. (162) left style, ventral view; (163) ♀ pregenital sternite, ventral view; (164) valve and left subgenital plate, lateral view; (165, 166) aedeagus, lateral and posterior views.

smaller size and female pregenital sternite with two lobes each side of the mid line. In the male genitalia *brevipenis* differs from *divergens* in having the apical region of the subgenital plate narrower, the ventral surface of the subgenital plate without long fine setae, the apical process of the style dentate and the aedeagus shorter with the apical processes parallel.

**DISTRIBUTION.** Borneo (Sarawak, Sabah).

**MATERIAL EXAMINED**

Holotype ♂, **Borneo:** Sarawak, foot of Mount Dulit, junction of R. Tinjar and Lejok, old secondary forest, at light, 29.viii.1932 (*Hobby & Moore*) (BMNH, London).

Paratypes. **Borneo:** 7 ♂, 10 ♀, same data as holotype, except 28.viii–4.x.1932; 1 ♀, Sarawak, Mount Dulit, moss forest, 1200 m, 21.x.1932 (*Hobby & Moore*) (BMNH, London); 1 ♂, Sabah, Bettotan, near Sandakan, 31.vii.1927 (BMNH, London); 1 ♀, Sabah, Tawau, Quoin Hill, at light, 26–29.vii.1962 (*Holtmann*) (BPBM, Honolulu).

*Karoseefa divergens* sp. n.

(Figs 162–166)

Length: ♀, 6.0 mm; ♂, 6.5–6.7 mm, mean 6.6 mm.

Colour and external characters as in generic description.

Male genitalia as in *brevipenis* but subgenital plate evenly tapered to apex and ventral surface of subgenital plate with numerous long fine setae laterally. Style with apical process less robust and crenulate dorsally and aedeagus with processes divergent.

Female genitalia with posterior margin of pregenital sternite with a single lobe each side of mid line.

**REMARKS.** This species is almost identical to *brevipenis* externally and is sympatric with this species over its known range in Sabah. For differences between the two species see 'Remarks' under *brevipenis* (p. 71).

**DISTRIBUTION.** Borneo (Sarawak, Sabah).

**MATERIAL EXAMINED**

Holotype ♂, **Borneo:** Sarawak, Gunong Mulu Nat. Park, Long Pala, 70 m, alluvial secondary forest, on batu canopy, at light, iii.1978 (*Holloway*) (BMNH, London).

Paratypes. **Borneo:** 1 ♀, Sarawak, Gunong Mulu Nat. Park, near Long Pala, 50 m, alluvial forest, understorey, at light, v.1978 (*Holloway*) (BMNH, London); 1 ♀, Sabah, Tawau, Quoin Hill, at light, 3–7.vii.1962 (*Holtmann*) (BPBM, Honolulu).

*OCEANOPONA* Linnavuori

*Oceanopona* Linnavuori, 1960: 300. Type-species: *Oceanopona croceipennis* Linnavuori, by original designation.

Yellow to stramineous; male with thorax and fore wing marked with brown.

Head wider than pronotum; anterior margin narrowly rounded in profile, transversely striate; ocelli on margin distant from eyes, visible from above; anterior tentorial branches curved anteriorly, not bifurcate. Vertex triangularly produced, medial length approximately 1.7 times length next to eyes, sides slightly convex, apex narrowly angularly rounded; shagreen and obscurely rugose, transversely striate anteriorly. Face approximately as long as wide, shagreen; more or less straight in profile; clypeus elongate, lateral margins constricted near antennae; clypellus elongate, expanded apically; transclypeal suture indistinct; lora large; antennal pit deep with inner margin angularly rounded to clypeus, rim-like; antennal ledge slight; antennae very long, extending to near apex of clavus. Pronotum approximately twice as wide as long, sides very short, without a carina; finely transversely striate, obscurely rugose anteriorly. Scutellum approximately equal in length to pronotum, shagreen. Fore wings with three subapical cells, first subapical cell open, second and third subapical cells closed. Fore tibia with dorsal setal arrangement 1 : 4; fore femur with a series of six fine setae distally on anterior surface; hind femur with apical setal formula 2 + 1 + 0.

Apodemes of male third abdominal segment ventral, reduced.

Male genitalia with anterior margin of pygophore slightly incurved dorsally, without apodemes; pygophore lobes with a slight oblique internal ledge, not attaining posterior margin, lobes with several macrosetae and short to moderately long fine setae. Xth segment moderately long, compressed dorsoventrally.

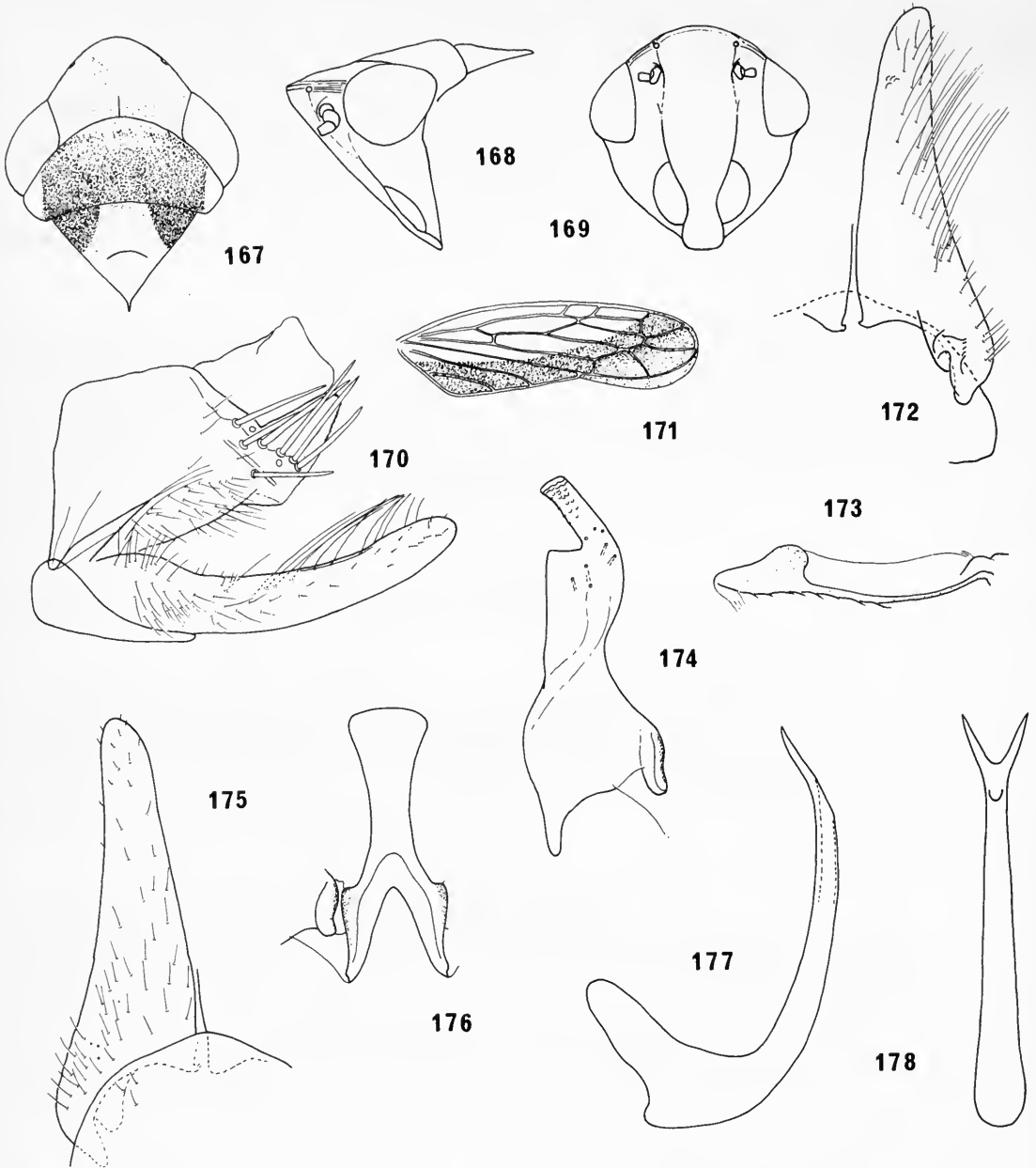

**Figs 167–178** *Oceanopona croseipennis*. 167, head and thorax, dorsal view; 168, same, lateral view; 169, face; 170, ♂ genital capsule, lateral view; 171, fore wing; 172, valve and left subgenital plate, dorsal view; 173, connective, lateral view; 174, left style, ventral view; 175, valve and left subgenital plate, ventral view; 176, connective, dorsal view; 177, 178, aedeagus, lateral and posterior views.

Valve triangular. Subgenital plate elongate, triangular, outer margin of dorsal surface with several short fine setae and a group of long fine setae from mid length to near apex; ventral surface with several short fine setae. Style moderately long with lateral lobe and basal apophyses prominent; apical process moderately long, turned ventrally with sides parallel, crenulate distally; few sensory papilla ventrally adjacent to lateral lobe. Connective Y-shaped, stem moderately long, narrow with lateral margins keel-like dorsally; arms with apophyses relatively long. Aedeagus with shaft elongate, curved dorsally, evenly tapered to apex and terminating in a pair of dorsally directed processes; gonopore apical on posterior surface, small; basal apodeme moderately long, narrow.

Female genitalia with second valvulae united at first dorsal tooth, fairly robust, slightly expanded distally, dorsoanterior prominence present; teeth fine, extending along approximately distal third of valvulae; dorsal sclerotized region moderately long.

REMARKS. This genus is similar externally to *Dryadomorpha* and *Parohinka* but with the vertex shagreen and obscurely rugose and the setal formula of the hind femur 2 + 1 + 0. The male genitalia are similar to those of *Dryadomorpha* and *Karoseefa* but with the internal ledge of the pygophore lobes not extending to the posterior margin and the connective with the apophyses of the basal arms relatively long. In the female genitalia the second valvulae are similar to those of *Dryadomorpha* but with the teeth extending along approximately the distal third of valvulae.

The specimen of *Oceanopona* recorded by Evans (1966: 247) from Australia is identified as *Dryadomorpha metrosideri* (Osborn).

DISTRIBUTION. Eastern Caroline Is.

### *Oceanopona croceipennis* Linnavuori

(Figs 167–178)

*Oceanopona croceipennis* Linnavuori, 1960: 301. Holotype ♂, CAROLINE IS. (BPBM, Honolulu) [examined].

Length: ♂, 4.4–4.7 mm, mean 4.6 mm; ♀, 5.9 mm.

Yellow or stramineous. Male with pronotum brown posteriorly; scutellum turning to brown anteriorly with basal triangles darker brown; legs heavily marked with brown; fore wings golden to yellow, sometimes tinged with green, with a broad dark brown band along clavus, on apical region of subapical cells and becoming slightly paler on apical cells and appendix. Female variably tinged with green, without brown markings.

External characters as in generic description.

Male genitalia as in generic description with lateral lobe of style short and angularly rounded in ventral aspect. Aedeagus with apical processes divergent, short.

Female genitalia with posterior margin of pregenital sternite shallowly concave.

DISTRIBUTION. Eastern Caroline Is.

#### MATERIAL EXAMINED

*Oceanopona croceipennis* Linnavuori, holotype ♂, Caroline Is.: Ponape, Mt Tamatamansakir, 180 m, 17.i.1953 (*Gressitt*) (BPBM, Honolulu).

Caroline Is.: 4 ♂, 1 ♀, Ponape, Mt Tamatamansakir, 180 m, 15–19.i.1953 (*Gressitt*) (BPBM, Honolulu) (paratypes of *Oceanopona croceipennis* Linnavuori); 1 ♂, Kusaie I., Matanluk, Yapan, 23.i.1953 (*Gressitt*) (BPBM, Honolulu) (paratype of *Oceanopona croceipennis* Linnavuori).

### References

- Bruner, L. 1908. The Acridiidae. *Biologia cent.-am.* Insecta. Orthoptera 2: 1–342.
- Distant, W. L. 1917. The Percy Sladen Trust Expedition to the Indian Ocean in 1905, under the leadership of Mr. J. Stanley Gardiner, M.A. Vol. VI, No. vii.—Rhynchota, Part II: Suborder Homoptera. *Trans. Linn. Soc. Lond.* 17: 273–322.
- 1918. In Blandford, W. T., *The fauna of British India including Ceylon and Burma. Rhynchota 7.* Homoptera: appendix. Heteroptera: addenda. vii + 210 pp. London.
- Dlabola, J. 1979. Neue Zikaden aus Anatolien, Iran und aus Südeuropäischen Ländern (Homoptera: Auchenorrhyncha). *Acta zool. hung.* 25: 235–257.
- Evans, J. W. 1966. The leafhoppers and froghoppers of Australia and New Zealand (Homoptera: Cicadelloidea and Cercopoidea). *Mem. Aust. Mus.* 12: 1–347.
- Eyles, A. C. & Linnavuori, R. 1974. Cicadellidae and Issidae (Homoptera) of Niue Island and material from the Cook Islands. *N. Z. J. Zool.* 1: 29–44.
- Gardner, J. A. 1916. Systematic paleontology of the Upper Cretaceous deposits of Maryland. Mollusca. *Md geol. Surv. stratigr. Mem.* 1916: 371–734.
- Hamilton, K. G. A. 1975. Review of the tribal classification of the leafhopper subfamily Aphrodinae (Deltocephalinae of Authors) of the Holarctic region (Rhynchota: Homoptera: Cicadellidae). *Can. Ent.* 107: 477–498.

- Haupt, H.** 1927. Homoptera Palestinae I. *Bull. agric. Exp. Stn, Tel-Aviv* **8**: 5–43.
- Ishihara, T.** 1954. Homopterous notes. *Scient. Rep. Matsuyama agric. Coll.* **14**: 1–28.
- Kirkaldy, G. W.** 1906. Leaf-hoppers and their natural enemies. (Pt. IX. Leaf-hoppers—Hemiptera). *Bull. Hawaiian Sug. Plrs' Ass. Exp. Stn (Ent.)* **1**: 271–479.
- 1907. Leaf-hoppers—supplement. (Hemiptera). *Bull. Hawaiian Sug. Plrs' Ass. Exp. Stn (Ent.)* **3**: 1–186.
- Lindberg, H.** 1958. Hemiptera Insularum Caboverdensium. *Commentat. biol.* **19**: 1–246.
- Linnavuori, R.** 1960. Insects of Micronesia. Homoptera Cicadellidae. *Insects Micronesia* **6**: 231–344.
- 1978. Revision of the Ethiopian Cicadellidae (Homoptera). Paraboloponinae and Deltocephalinae: Scaphytopiini and Goniagnathini. *Revue zool. afr.* **92**: 457–500.
- Matsumura, S.** 1912. Die Acocephalinen und Bythoscopien Japans. *J. Coll. Agric. Hokkaido imp. Univ.* **4**: 279–325.
- Melichar, L.** 1914. Homopteren von Java, gesammelt von Herrn Edw. Jacobson. *Notes Leyden Mus.* **36**: 91–147.
- Merino, G.** 1936. Philippine Cicadellidae (Homoptera). *Philipp. J. Sci.* **61**: 307–400.
- Osborn, H.** 1934. Cicadellidae of the Marquesas Islands. *Bull. Bernice P. Bishop Mus.* **114**: 239–269.
- Pruthi, H. S.** 1930. Studies on Indian Jassidae (Homoptera). Part I. Introductory and description of some new genera and species. *Mem. Indian Mus.* **11**: 1–68.
- 1934. Entomological investigations on the spike disease of sandal. (14) Jassidae (Homopt.). *Indian Forest Rec.* **19**: 1–30.
- Uhler, P. R.** 1896. Summary of the Hemiptera of Japan presented to the United States National Museum by Professor Mitzukuri. *Proc. U.S. natn. Mus.* **19**: 255–297.
- Webb, M. D.** 1980. The Cicadellidae from Aldabra, Astove and Cosmoledo Atolls collected by the Royal Society Expedition 1967–68 (Hemiptera, Homoptera). *J. nat. Hist.* **14**: 829–863.

## Index

Invalid names are in *italics*; references to descriptions are in **bold**.

- anacryon 40, 50  
*antennalis* 40, 50  
 apicalis 58, 59, 66, 67, **68**  
*australis* 51  
 brevicephala 58, 59, 64, **66**, 68  
 brevipennis 70, **71**, 73  
*Calotettix* 39, 49  
 camphorae 39, 40, **48**  
*chatterjeei* 40, 50  
 chinensis 43, **45**, 46  
 croceipennis 39, 73, **75**  
 divergens 71, **73**  
 Dryadomorpha 40, 42, **49**, 50,  
 57  
 dulita 58, 59, **64**, 66, 67, 68  
 falcata 40  
 Favintiga 40, 42, **47**  
 fraternus 40, 50  
 guttata 39, **43**, 45, 46  
*indicus* 40, 50  
 ishihari 43, **45**, 46  
*Khamiria* 49  
 Karoseefa 42, 50, 58, **70**, 73  
*lais* 39  
 longiseta 40, 57, 58, 59, 64, 66,  
 67, **68**, 70  
 lotophagorum 40, 58, 59, 61,  
**63**, 64  
 lugubris 50  
 luzonensis 43, **46**  
 malayensis 58, 59, 68, **70**  
 mangrovecola 50  
 merinoi 56, **57**  
 metrosideri 39, 50, 53, 54, 75  
*modestus* 39  
 morona 58, 59, **60**, 61, 63, 64,  
 66, 67, 70  
 Oceanopona 39, 42, 58, **73**, 75  
*Odmia* 40, 42  
*Osbornitettix* **49**  
 pacifica 50, **53**  
*Paganalia* 40, 49  
 pallida 40, **50**, 54, 55  
 Parabolopona 39, 40, **42**, 47  
 Parohinka 42, 50, **57**, 71, 73  
 philippina 58, 59, **66**, 68  
*punctatus* 40, 50  
 quadricornis 40, 50  
 recurva 58, 59, **67**, 68  
*Rhombopsana* 40  
*Rhombopsis* 40, 49  
 Rhutelorbis 42, 50, **56**, 58, 71  
 robustipennis 50, **54**, 55  
 rubrolineata 39  
 sinuata 58, 59, **61**, 63, 64  
 spinosa 58, 59, 63, **64**  
 Stenomiella 40, 42  
 Stirellus 50  
 Stymphylus 39  
*tincta* 39  
 trispicata 58, 59, **61**, 63, 64  
 virens 40, 50  
 virescens 40  
 viridia **54**  
 viridis 40, 50  
 Yakunopona 40, 49  
 yakushimensis 40, 51  
 Zizyphoides 40, 49, 50







**British Museum (Natural History)**  
**1881—1981**

**Centenary Publications**

***Chance, change & challenge***

Two multi-author volumes from one of the foremost scientific institutions in the world.

General Editor: P. H. Greenwood

**The Evolving Earth**

Editor: L. R. M. Cocks

**The Evolving Biosphere**

Editor: P. L. Forey

In the first volume, *The Evolving Earth*, twenty scientists have been asked to review the present state of knowledge in their particular field, ranging from the origin of the Earth, through ocean sediments and soils to continental drift and palaeogeography.

In the companion volume, *The Evolving Biosphere*, museum scientists have chosen an evolutionary concept—speciation, coevolution, biogeography etc. and related this to the group of animals or plants in which they are specialising. Thus beetles and birds exemplify sympatric and allopatric speciation, butterflies mimicry and certain fishes explosive evolution.

In both volumes the text is supplemented by over one hundred specially-commissioned pieces of two-colour artwork.

These two books will be invaluable to all sixth-form and undergraduate biology and geology students.

*The Evolving Earth*: 276 × 219 mm, 280pp, 138 line illustrations, 42 halftones

*The Evolving Biosphere*: 276 × 219 mm, approx. 320pp, 133 line illustrations

Published: May 1981

Co-published by the British Museum (Natural History), London and Cambridge University Press, Cambridge.

## **Titles to be published in Volume 43**

**A revision of the genus *Usambilla* Sjöstedt (Orthoptera : Acridoidea) and its allies.  
By N. D. Jago.**

**The Asian, Australasian and Pacific Paraboloponinae (Homoptera : Cicadellidae).  
A taxonomic revision with a key to all the known genera of the subfamily.  
By M. D. Webb.**

**A revision of *Phyciodes* Hübner and related genera, with a review of the classification  
of the Melitaeinae (Lepidoptera : Nymphalidae). By L. G. Higgins.**

**A revision of six minor genera of Myrmicinae (Hymenoptera : Formicidae) in the  
Ethiopian zoogeographical region. By Barry Bolton.**

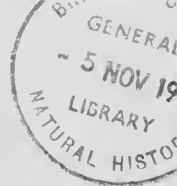

# Bulletin of the British Museum (Natural History)

A revision of *Phyciodes* Hübner and related genera, with a review of the classification of the Melitaeinae (Lepidoptera: Nymphalidae)

L. G. Higgins

Entomology series  
Vol 43 No 3

29 October 1988

The *Bulletin of the British Museum (Natural History)*, instituted in 1949, is issued in four scientific series, Botany, Entomology, Geology (incorporating Mineralogy) and Zoology, and an Historical series.

Papers in the *Bulletin* are primarily the results of research carried out on the unique and ever-growing collections of the Museum, both by the scientific staff of the Museum and by specialists from elsewhere who make use of the Museum's resources. Many of the papers are works of reference that will remain indispensable for years to come.

Parts are published at irregular intervals as they become ready, each is complete in itself, available separately, and individually priced. Volumes contain about 300 pages and several volumes may appear within a calendar year. Subscriptions may be placed for one or more of the series on either an Annual or Per Volume basis. Prices vary according to the contents of the individual parts. Orders and enquiries should be sent to:

Publications Sales,  
British Museum (Natural History),  
Cromwell Road,  
London SW7 5BD,  
England.

*World List* abbreviation: *Bull. Br. Mus. nat. Hist.* (Ent.)

© Trustees of the British Museum (Natural History), 1981

ISSN 0524-6431

British Museum (Natural History)  
Cromwell Road  
London SW7 5BD

Entomology series  
Vol 43 No 3 pp 77-243

Issued 29 October 1981



# A revision of *Phyciodes* Hübner and related genera, with a review of the classification of the Melitaeinae (Lepidoptera: Nymphalidae)

L. G. Higgins

Focklesbrook Farm, Chobham, Woking, Surrey

## Contents

Synopsis	78
Introduction	78
Historical review	78
Abbreviations of depositories	79
Type-material and the British Museum (Natural History) collections	79
Phyciodine genitalia and the identification keys	80
Examination of Phyciodine genitalia	80
Taxonomy	81
Phyciodini trib. n.	81
Tribal characters	81
Distribution	82
Wing patterns	83
Key to genera of Phyciodini	84
<i>Phyciodes</i> Hübner	85
<i>Phystis</i> gen. n.	93
<i>Anthanassa</i> Scudder	94
<i>Dagon</i> gen. n.	108
<i>Telenassa</i> gen. n.	110
<i>Ortilia</i> gen. n.	115
<i>Tisona</i> gen. n.	120
<i>Tegosa</i> gen. n.	121
<i>Eresia</i> Boisduval	129
<i>Castilia</i> gen. n.	151
<i>Janatella</i> gen. n.	157
<i>Mazia</i> gen. n.	159
Species incertae sedis	160
Supplement on certain genera of Melitaeini	160
<i>Gnathotriche</i> Felder & Felder	160
<i>Gnathotrusia</i> gen. n.	162
<i>Higginsius</i> Hemming	163
<i>Antillea</i> Higgins	164
Review of the classification of the Melitaeinae	164
Check-list of tribes, generic groups, genera and species of the Melitaeinae	165
Distribution	171
Palearctic region	171
Nearctic and Neotropical regions	173
Acknowledgements	174
References	175
Index	238

## Synopsis

The new tribe Phycioidini is defined and its constituent taxa revised at the generic and specific levels, thus completing an account of the nymphalid subfamily Melitaeinae commenced by the author over 40 years ago. An historical account of the taxonomy of the group is included, together with information on type-material, and the taxonomic and practical methods employed. The geographical distribution and wing patterns of the 137 included species are discussed. A key to the twelve genera is provided and a key to species is given for each genus in turn. The account of each species includes a full synonymy of nominal species and forms, and a brief morphological description and a summary of distribution. A supplementary section deals with four divergent genera of American Melitaeini previously often confused with the Phycioidini. Finally, an overview of the author's conclusions concerning the classification of the Melitaeinae is given, including a complete check-list of the tribes, generic groups and species of the subfamily. The taxonomic work results in the description of ten new genera, five new species, and three new subspecies; 135 changes in combination, one new generic synonym, 35 new specific synonyms, and 38 changes of specific status are established; three species are raised from synonymy; one new specific name is proposed; and 106 lectotypes are designated.

## Introduction

This account of the Phycioidini has two main objectives. The first one is to examine the characters of this large tribal group of over 130 species, and to analyse the relationships of the various subgroups of generic status which are defined and named. The second objective, dependent upon the first, needs explanation. I have had a special interest in the Melitaeinae for a great many years, and reviews of the Palaearctic species, and of the American *Chlosyne* and their allies, have already appeared (Higgins, 1941; 1950; 1955; 1960). The present review of the Phycioidini, and the accompanying account of the small Melitaeine genera related to *Gnathotriche* Felder & Felder, will complete the analysis, by a single worker, of the entire subfamily, including about 240 species. Apart from a consistent taxonomic treatment, the comprehensive account could reveal interesting features which may be overlooked when the series is considered, as is usual, as consisting of independent Eurasiatic and American groups.

## Historical review

The history of the Phycioidini goes back to 1819, when Hübner introduced the generic name *Phyciodes* for two American species, *cocyta* Cramer and *liriope* Cramer, united generically by the rather unimpressive character of 'reticulate markings' on the undersides of the hindwings. The new genus was placed by the author in his group of Dryads, a creditable decision at that early date. Seventeen years later Boisduval (1836) published the name *Eresia eunica* (recte *eunice*) by means of a figure only, erecting a new genus without any description or definition. Soon afterwards, as interest increased in the butterflies of Central and South America, many new species were described by various authors including the Felders, Bates, Hewitson, Druce and, later, Godman & Salvin, using the generic names *Melitaea*, *Eresia*, *Phyciodes* etc. according to personal preference—since the characters of these genera were not defined.

In fact, definition was not possible, at this date, since characters used in the nineteenth, and in the early years of the present, century were not adequate for the taxonomic analysis of these butterflies. Nevertheless, in 1875 Scudder proposed the genus *Anthanassa*, with somewhat equivocal characters and a type-species of uncertain identity, evidence that the complex nature of the tribe was becoming recognised. Seven years later, in 1882, Godman & Salvin made a distinction between *Eresia* and *Phyciodes*, and separated these from the American *Chlosyne* (Melitaeini) and their allies, partly on the characters of their genitalia. This useful hint was not followed up by later authors. Schatz (1892), in his article on the Melitaeinae, separated *Melitaea* from *Phyciodes*, with a note that it was customary to do so, but that there was not any good distinctive character.

Schatz's careful review provided the basis for Röber's long article on *Phyciodes* in Seitz (1913–1914). A similar system was adopted by the late Arthur Hall in his 'Revision of the genus *Phyciodes*' (1928–1930).



In his account Hall recognised only the genus *Phyciodes*, to include not only *Eresia* and *Anthanassa*, but also numerous American species of Melitaeini such as *harrisii* Scudder and its allies, already distinguished and very properly removed from *Phyciodes* by Godman & Salvin, Staudinger, Schatz and others. In doing this, Hall made a serious taxonomic mistake, but in other respects his work was a most important contribution. He had the advantage of knowing many species in the field, and had easy access to the extensive collections of Rothschild and of Joicey, and to the collection in the British Museum (Natural History), all containing much original type-material. With excellent library facilities he succeeded in establishing the complicated synonymies of most species and also assembled the confusing polymorphic and mimetic phenotypes in an outstanding study which has made his work essential to all later students. There are occasional references to relationships disclosed by examination of the male genitalia, but by modern standards this part of his work is not helpful. Revision of Hall's work was clearly necessary. This was undertaken by W. T. M. Forbes (1945), who made free use of the genitalia in an improved taxonomic arrangement on modern lines. In this review the North American species allied to *palla* are placed in *Melitaea*, and the Felders' genus *Gnathotriche* is retained, while the remaining species are all included in *Phyciodes*, used in a tribal sense, and divided into 13 groups with three named subgenera. This paper marks an important advance in the study of the group, but still fails to provide a generic definition for *Phyciodes*. Forbes contented himself with the remark '... the boundary against *Melitaea* is universally agreed to be indefinite, one might almost say non-existent, if we consider only superficial characters'. Certainly this extensive group does present difficulties. Natural affinities are so often obscured by mimetic resemblances to unrelated, naturally protected species. In the present paper the species retained by Forbes in *Phyciodes* have been allocated to 12 genera, based principally upon the characters of the male genitalia.

### Abbreviations of depositories

AMNH, New York	American Museum of Natural History, New York
BM, Brighton	Booth Museum, Brighton
BMNH	British Museum (Natural History), London
CAS, San Francisco	California Academy of Sciences, San Francisco
CM, Pittsburgh	Carnegie Museum, Pittsburgh
CNC, Ottawa	Canadian National Collection, Ottawa
FMNH, Chicago	Field Museum of Natural History, Chicago
IML, Tucumán	Instituto Miguel Lillo, Tucumán
MACN, Beunos Aires	Museo Argentino Ciencias Naturales, Buenos Aires
MN, Rio de Janeiro	Museu Nacional, Rio de Janeiro
MNHN, Paris	Muséum National d'Histoire Naturelle, Paris
MNHU, Berlin	Museum für Naturkunde der Humboldt-Universität, Berlin
NM, Vienna	Naturhistorisches Museum, Vienna
NR, Stockholm	Naturhistoriska Riksmuseet, Stockholm
RSM, Edinburgh	Royal Scottish Museum, Edinburgh
UM, Oxford	University Museum, Oxford
USNM, Washington	National Museum of Natural History, Washington, D.C.
ZI, Leningrad	Zoological Institute, Leningrad

### Type-material and the British Museum (Natural History) collections

I have never been in Central or South America, and this review is based on the material in the BMNH, most of which was assembled between the middle and the end of the last century. This huge collection includes not only the entirety of the Rothschild Collection, but much other material from Bates, Hewitson, Godman & Salvin, Oberthür and Joicey. The Rothschild Collection itself included much material from the Felders, and from Röber. Finally, the BMNH collection includes many specimens collected by Arthur Hall, who was the last person to re-arrange the BMNH Phyciodini, although Hall's private collection (together with his voluminous manuscript notes) passed to the BM, Brighton, Sussex (where I have examined it).

Thus the BMNH collection includes type-material covering over 75 per cent. of the phyciodine species recognised at present (including approximately 50 per cent of nominal species). With this, and much of the other material, the provenance from individual collections is almost always recorded, sometimes the names of the actual collectors, and often the year of collection, although very few specimens are accurately dated. As always with material of this vintage, even the actual locality data are often vague, totally wanting, or even downright misleading; however, most of the false data labels are now tolerably well known, and their 'information' can be discarded or re-interpreted.

In their descriptions the early authors sometimes referred to 'types', but the actual specimens were rarely so-labelled. Throughout this treatment, original specimens have been regarded as holotypes only where there is clear evidence or a statement in the original description as to their unique status. In all other cases, where original material has been positively identified and examined, lectotypes have been designated, in accordance with the suggestions put forward by Vane-Wright (1975: 26-28). Where original material has not been traced or examined, information has been included, as far as is available from the original description, as to the number, sex and status of primary type-specimens, and their provenance and present depository, where known. With respect to the BMNH types in particular, a great many were previously listed in A. G. Gabriel's excellent catalogue, published in 1927; wherever possible the present type designations have been cross-referenced to Gabriel's catalogue and type-specimen numbers.

### **Phyciodine genitalia and the identification keys**

In making this study it has been necessary to examine the genitalia of every available species, and these are now illustrated, with other anatomical characters, in a series of some 313 figures, taken from camera lucida drawings made by myself. The original preparations naturally vary greatly in size, and it has not been possible to make the drawings really uniform in this respect. In all cases size is indicated by a 1 mm scale line. Keys to genera and species have been included. Unfortunately external characters are often misleading at the generic level, so the key to genera is based largely upon genitalic characters. I have not been able to devise for the species of the whole tribe a single workable key based upon wing markings, size and similar external features. Keys to the species of each genus are provided, however, based upon external characters as far as possible, but such keys are only usable after a specimen has been correctly placed generically. This is easy if the male genitalia are examined. Distinction between closely similar species may be difficult and the keys will be useful in making the final identification, with the help of the photographic plates.

#### **Examination of Phyciodine genitalia**

Preparation of the male genitalia of the Phyciodini needs special care. The organs are usually very small, fragile, and unsuitable for dissection. Every care must be taken to avoid distortion, and the genitalia should be mounted in a shallow cell, free from pressure, in a position which will give a view of the parts at exactly the same angle in all cases, in order to allow comparison between different preparations. Owing to the oval shape of the valves, the only position in which the organs are stable is erect, the dorsal structures upwards, resting on the saccus and the lower borders of the valves. This position gives a good view of all taxonomically important parts. The penis should be extracted and mounted to give a lateral (side) view. There is a difficulty here when a single specimen only is available, as it is easy to damage the dorsal structures when the penis is removed. Any distortion will destroy the symmetry of the organs and mounting in the correct position will be difficult. The penis shape in most species is flattened antero-posteriorly, and manipulation will be required to secure a lateral view in a permanent preparation. It is often best to leave the penis in position until immediately before mounting, as it is easily lost if it is removed at an early stage of preparation.

The elaborate sterigma of the female genitalia is displayed if the abdomen is opened along the dorsum and the lateral walls are spread flat on each side. When the parts are cleaned, care must be taken to leave the bursa in its correct position, lying along the ventral abdominal plates.

Prepared in this way and allowed to dry upon the slide for a day or so, the specimen can be taken off by undercutting with a thin knife when it will remain flat while it is dehydrated and cleared for mounting in the usual way. A few drops of alcohol will help to loosen the dried specimen before it is removed from the slide.

### Taxonomy

The collections with which I have worked have covered the whole, vast area of tribal distribution, but representation is uneven. Often the material has been collected from a single locality, perhaps during a single visit, and so for many species it is not possible to define distributional frontiers. This leads to taxonomic difficulties as often there is little information about seasonal variation or possible distributional overlap or clinal series. In the absence of this information it is only by guessing that the status, local or individual form, seasonal modification or geographical subspecies, can be decided, when specimens with slightly differing phenotypical characters are reported flying in widely separated localities. In such cases, when the differing characters are constant and easily recognisable, the butterflies are treated here as distinct species, in order to emphasise their individuality. I have found it necessary to introduce 10 new genera and to describe eight new species or subspecies. A single familiar name has been found to be invalid. This is *Eresia 'clio'* of Aurivillius (1882) and of many later authors, which certainly is not the species named *Papilio clio* by Linnaeus, which is probably an Ithomiine, perhaps *Ithomia aegle* (F.) as figured in 'Seitz' (pl. 38, row f [Fig. 5]). I understand from Dr Holm, the Curator of the Linnaean (i.e. Queen Ulrica's) collection at Uppsala, that the single original specimen of '*clio* auct' is there labelled *nauplius*, as it is in the figures in Clerck's *Icones*.

In the synonymy given for each species, I have indicated when I have examined the type-material of each nominal taxon by the annotation '[examined]'. Where type-material has not been examined, the assignment of any name must be regarded in some sense as tentative or provisional, as the examination of the genitalia is of critical importance in most species.

### PHYCIODINI trib. n.

(Figs 178–185)

Type-genus: *Phyciodes* Hübner.

In the Melitaeinae, of which the Phyciodini form the largest section, the structure of the antennae, palpi, legs and the wing venation is almost uniform throughout the subfamily. It has not been generally recognised that almost all such characters are of subfamily value, but their uniformity has proved to be a serious difficulty in recognition of the tribal status of the Phyciodini and for their classification at generic levels. It is in the structure of the genitalia that characters below the subfamily level are well defined and the individuality of the Phyciodini is seen to isolate them from other melitaeine tribes. Careful examination of every available species (about 135) has failed to show any with intermediate or ambiguous tribal features.

#### Tribal characters

Small or medium-sized butterflies, forewing 11–30 mm (Fig. 178), cell closed by vestigial veins,  $v_{11}$  arises near cell-end except in a few genera (*Mazia*, p. 159; *Castilia*, p. 151) in which it arises at or beyond cell-end. Hindwing (Fig. 179) cell open, precostal vein well developed.

*Palpi* (Fig. 180) porrect or semi-ascending, terminal segment narrow, middle segment usually slightly dilated, clothed beneath with long or, in *Castilia*, very long hair.

*Legs* of usual nymphaline type, ♂ foreleg greatly atrophied (Fig. 181), tarsus often reduced to a single segment, tibiae of mid- and hindlegs with slender spines and a single pair of spurs.

*Early stages*. Characters of ovum, larva and pupa, when known, similar to those of *Melitaea*; larval spines in *Phyciodes* represented by little more than hairy tubercles (*P. tharos*).

*Male genitalia* (Figs 182–184). In all melitaeine butterflies the genitalic structure is unusual, especially in respect of the absence of an uncus and in the fusion of the saccus and juxta to

form a strongly chitinised basal plate (Higgins, 1941). In the Phyciodini the genitalia show little variation from this basic type. As discussed above, the organs are best examined entire, without any dissection of the valves, which may be confusing, since their lateral walls are rounded and the absence of a flat lateral surface to support the isolated organ at a constant angle prevents accurate comparison between different preparations. In most cases examination of a dorsal view of the intact organs is most valuable, showing the special features of tribal and generic value, as follows.

Tegumen (A) and scaphial extension (E) (Figs 182, 183). These dorsal structures, taken together, are almost always well developed, and form an important feature of the organs in *Eresia*, *Phyciodes*, *Tegosa* and *Janatella*. This is in contrast with the usual structure in the Melitaeini, in which the tegumen is commonly small or even vestigial. In the Phyciodini minor variations in shape and in the development of spinous areas provide generic characters of value. In many species the lateral walls of the scaphial extension (E) are more or less chitinised (Figs 182, 183), with the space between covered by a membranous curtain, which may extend as an inferior layer, sometimes partly chitinised, forming the floor of the anal compartment.

Saccus (S). This structure, fused with the juxta (J), is always well developed. It is often deeply cleft, as in the Melitaeini, but it is entire (lingulate) in the genera *Eresia*, *Janatella*, *Ortilia* and *Tegosa* (part), often with a small apical notch and associated with unusual development of the dorsal structures. Among the Melitaeini, a saccus of this type is found only in *Didymaeformia trivialis* and in *Melitaea lukto* in its various forms, the former usually considered a divergent relict species.

Valves (V). Throughout the entire tribe these are oval, elongate posteriorly, with relatively little variation. Near the apex the costal border often has small teeth which are enlarged in *Anthanassa* and in *Ortilia*, to give the appearance of a bifid apex (Fig. 225). In the genera *Telenassa* and *Castilia* the posterior sections of the valves have a characteristic form, giving a generic character. The harpe (H) is always well developed, the structure usually simple, occasionally with a few basal teeth on the underside (Fig. 268).

Penis (P) or aedeagus (Fig. 184). In all species this is straight or nearly so, with a well-defined morula (M). An ostium-keel (OK) is present in the genera *Eresia*, *Castilia*, *Janatella* and *Phyciodes* (part), not so prominent as it is in the melitaeine genus *Mellicta*, and in *Phyciodes* quite small, but large enough in most species to show distant relationship. The penis may be slender or stout, e.g. in *Telenassa* (Fig. 297) in which the organ is massive.

*Female genitalia* (Fig. 185). The structure of the sterigma is distinctive and often elaborate. The ostium bursae (O) opens between segments 7 and 8, usually at the bottom of a deep pit; the bursal duct (BD) is partly chitinized and surmounted by a structure that I have called the bursal support (BS), often egg-shaped, sometimes with three lateral projections or ribs (e.g. *Eresia coela*, Fig. 389), to which the bursa copulatrix (B) is attached. This structure, with the formation of the bursal support, is peculiar to the Phyciodini and forms an excellent tribal character. The genital plate extends across segment 8 as a modified area named the scutum (S).

### Distribution

The Phyciodini are restricted to America, and widely distributed throughout the continent from about 55°N to 35°S. The species usually occur in localised colonies, and do not appear to have any tendency to migrate or to wander. Owing to lack of information and of material from large areas, especially in South America, it is not possible to be precise about distribution patterns of genera or species, but in general terms I think the following picture is reasonably accurate.

The genus *Phyciodes* alone is represented in Canada and in most of the United States, excepting the fringe areas in the south where some tropical species have penetrated. *Anthanassa*, which begins to appear in Mexico and in Arizona, is a large genus developed extensively in Central America, Colombia and Venezuela, with single divergent species in the east in Argentina and Brazil (*hermas*) and in Jamaica and Cuba (*frisias*). Further south in S. Peru, Bolivia and in S.W. Argentina, there is *Dagon*, with three (or four?) rather isolated and small, rare species, all closely related. The genus *Telenassa*, with about 16 species, occurs in the mountainous

western regions of Peru, Colombia and Ecuador. The saccus is deeply cleft in all species. In eastern South America its place is taken by *Ortilia*, with 10 species, widely distributed in C. and S. Brazil, Paraguay, and Argentina, but overlapping the *Telenassa* area in Peru and Bolivia. All species have a single (entire) saccus, and this genus is accompanied over much of the region by *Phystis*, a monotypic genus, the single small and variable species recalling *Phyciodes* in certain respects. The largest genus, *Eresia*, with about 35 species, includes many mimetic and polymorphic forms. Although especially characteristic of Central America, it extends throughout the area south of the United States, with endemic species in the Guyanas and in NE. Brazil (Amazon). A large genus, *Tegosa*, including many small species with orange-yellow wings with dark borders, is widely distributed in Central and South America, and includes several small and localised species endemic in Ecuador and Peru. Probably closely related is *Tisona*, endemic in the Chaco district of Argentina and in Bolivia. The male genitalia of the single species have several unusual features (Figs 321–323). The genus *Castilia* includes about 12 species, of which four are mimetic of *Actinote*, occurring over a wide area in tropical Central America, Colombia and Guatemala. In three of these species the venation of the forewing is atypical. The external features of the remaining species are variable, but good generic characters are provided by the genitalia. Another small group is *Janatella* with three species occurring from Ecuador and Central America to the Guyanas, probably related most closely to *Eresia*. Finally, in *Mazia*, the third monotypic genus, the single species *amazonica* is divergent in wing markings, wing venation and in the characters of the genitalia, and although undoubtedly a member of the Phyciodini, it is difficult to suggest any near relative. The species appears to be widely distributed over the vast drainage system of the Amazon. In hindsight, the astonishing concentration of species in Central America, Venezuela and Colombia, is most striking, yet only one species, *Anthanassa frisia*, has become established in Cuba and in a few other islands, to represent the Phyciodini in the Greater Antilles. *Phyciodes phaon*, which occurs in the Cayman Islands and probably in Cuba, is an outlier from North America where all its relationships lie. It appears as an alien among the true fauna of Mexico and Central America.

### Wing patterns

On the upperside of the Melitaeinae there is a remarkably constant basic or standard pattern, with black striae and/or spots in series upon a buff coloured or orange-red ground-colour, present and immediately recognisable in all Palaearctic and Nearctic species, with the exception of two euphydryad butterflies, *phaeton* (both sexes) and *cynthia* (♂ only). On the underside of the hindwing the arrangement of reddish spots in basal and submarginal series is even more constant and characteristic. This scheme of markings, which appears in all species distributed over the areas of Quarternary glaciation, must be recognised as an important character of the subfamily Melitaeinae. In the tribe Phyciodini, the standard markings are present in the species of the genus *Phyciodes*, which inhabit principally the temperate northern regions of America, but in Mexico and further south to Argentina, Bolivia and Peru, the standard markings do not appear, but are altered in all species by mimicry (*Chlosyne*) or they become variable (Phyciodini), sometimes with mimicry, but often with different arrangements characteristic of different genera (e.g. *Tegosa*, *Ortilia*, *Anthanassa*, etc.).

*Mimicry.* In *Eresia* and *Castilia* many species are mimetic, and wing shapes and markings may be altered from the usual generic patterns. Heliconiine, ithomiine and acraeinae species are the most frequent models, including such genera as *Ceratinia* Hübner, *Napeogenes* Bates, *Ithomia* Hübner, *Eueides* Hübner and *Actinote* Hübner, all recognised distasteful groups. In *Eresia eutropia*, *E. pelonia* and *E. eunice*, polymorphism, especially among females, is so varied that it is impossible to find a satisfactory name for every form. In all such cases the mimicry appears to be of the classical Batesian type (pseudaposematic), and much information on this subject, based upon personal observation, is recorded by Hall (1928–1930). In addition there is a strong tendency towards mimicry, or to independent development of similar wing markings, between species in different genera among the Phyciodini, or even between phyciodine species and those of other unprotected groups. It is difficult to explain the value of repetitive wing markings (or mimicry?)

of this type, but it may be that the protection afforded by certain simple wing patterns is not understood. The following examples are especially striking.

*Ortilia liriopae* and *Tegosa claudina*, confused by everyone until separated by Forbes (1945) after genitalia examination.

*Janatella leucodesma* and *Dynamine* Hübner spp.

*Telenassa abas* and *Janatella fellula*. Wing markings almost identical but genitalia do not indicate close relationship.

*Janatella hera* and *Castilia ofella*. The similarity is remarkable. It seems unlikely that the two species ever fly together or even in the same regions.

Adams & Bernard (1979) have described some rather similar examples of puzzling convergence between unrelated but, in this case, definitely sympatric members of the Andean pronophiline satyrid fauna. One possible explanation involves the concept of arithmetic mimicry, as originally put forward by Van Someren & Jackson (1959), and discussed by Vane-Wright (1976: 37-38). Robson & Richards (1936: 260) refer to the earlier observations by Chapman (1913) and myself (Higgins, 1930) on conceivably similar phenomena among alpine species of *Erebia* Dalman in the Palaearctic region.

### Key to genera of Phyciodini

- |    |  |                           |
|----|--|---------------------------|
| 1  | Antennal club slender, elongate (Fig. 491)   | <i>MAZIA</i> (p. 159)     |
| -  | Antennal club larger, pyriform (Fig. 227)  | 2                         |
| 2  | Penis apex with crossing ostium-folds (Fig. 323)   | <i>TISONA</i> (p. 120)    |
| -  | Penis apex not so formed   | 3                         |
| 3  | Scaphial extension of tegumen elongate, terminal angles armed with hooks or spines (Fig. 383)  | 4                         |
| -  | Scaphial extension of tegumen small, terminal angles lacking hooks or spines                   | 7                         |
| 4  | Upperside of forewing usually yellow, marginal borders and oblique subapical bar black         | <i>TEGOSA</i> (p. 121)    |
| -  | Upperside of forewing not so marked  | 5                         |
| 5  | Saccus deeply cleft  | <i>PHYCIODES</i> (p. 85)  |
| -  | Saccus single  | 6                         |
| 6  | In dorsal view lateral angles of tegumen armed with 3 or 4 strong teeth (Fig. 471)             | <i>JANATELLA</i> (p. 157) |
| -  | In dorsal view lateral angles of tegumen appearing as rounded, spiculate bosses (Fig. 364)     | <i>ERESIA</i> (p. 129)    |
| 7  | Hindwing upperside submarginal band formed of 5 ocellar spots                                  | <i>PHYSTIS</i> (p. 93)    |
| -  | Hindwing upperside submarginal band not so formed, or absent                                   | 8                         |
| 8  | Saccus single, more or less expanded to broadly notched apex (Fig. 270)                        | <i>DAGON</i> (p. 108)     |
| -  | Saccus not so formed   | 9                         |
| 9  | Saccus single, narrow or tapering to apex (Fig. 302)   | <i>ORTILIA</i> (p. 115)   |
| -  | Saccus cleft   | 10                        |
| 10 | Posterior section of valve short, penis slender  | <i>ANTHANASSA</i> (p. 94) |
| -  | Posterior process of valve longer, penis massive   | 11                        |
| 11 | Posterior section of penis short, about one-third total length, ostium-keel lacking (Fig. 279) | <i>TELENASSA</i> (p. 110) |
| -  | Posterior section of penis about half total length, ostium-keel prominent (Fig. 465)           | <i>CASTILIA</i> (p. 151)  |

\* In *Tegosa* the black marginal upperside borders may be extended into wide, dusky suffusions, e.g. *T. etia* (p. 127); *T. nigrella* (p. 128).

\*\* The male genitalia show other distinctive characters but the features of the penis are sufficiently striking for the purposes of this key.

*PHYCIODES* Hübner

*Phyciodes* Hübner, [1819]: 29. Type-species: *Papilio cocyta* Cramer [= *Phyciodes tharos* (Drury)], by subsequent designation (Scudder, 1872: 46). Gender: masculine.

Small butterflies, forewing outer margin straight or slightly excavate; upperside orange-fulvous marked with black spots and stripes, recalling Palaearctic species of Melitaeini; hindwing underside a pale yellow or silvered marginal crescent usually present in s3. Sexes similar, mimetic forms absent.

*Genitalia*. ♂, in dorsal view, tegumen elongate, scaphial extension tapering slightly to a wide apex, terminating in one or more small hooks at each lateral angle, valve elongate, tapering gradually to an incurved, pointed apex, preceded by one or more small costal teeth; penis slender, almost straight, with small ostium-keel and morula. ♀ ductus chitinised, rather long, well defined, bursal support elongate (Fig. 192).

**DISTRIBUTION.** The species are widely distributed and often common in North America, especially in the western states of the U.S.A. Four small species, almost restricted to the southern states, range further south into Mexico and Guatemala. The little *P. phaon* has spread from Georgia to the Cayman Islands.

**DISCUSSION.** The species *tharos*, *batesii*, *campestris* and *montanus* all have similar markings, are sometimes difficult to identify, and specific characters in the male genitalia are poorly developed. In some specimens the scaphial hooks are bent over in a curious way, but without obvious fracture. It seems possible that the distortion happens during life when the tissues are elastic.

**Key to species of *Phyciodes***

*Note.* It has not been practicable to include *P. herlani* (p. 90), *P. pallidus* (p. 89) and *P. orseis* (p. 90) in this key.

Most species are variable in size. Identification may be difficult, especially in *P. mylitta*, in which the black upperside markings may be expanded (rare). It has proved difficult to key out *P. montanus*, lightly marked but otherwise resembling *P. campestris*, and considered a high-level form of the latter by many authorities. Except for *P. vesta*, and perhaps for *P. mylitta* (including *herlani*, *pallidus* and *orseis*), the male genitalia are not really helpful in making identifications.

- |   |  |  |
|---|--|--|
| 1 | Two or more hooks at each angle of scaphial extension (Fig. 217)                     | <i>vesta</i> (p. 92)                               |
| - | Single hook at each angle (Fig. 186)   | 2  |
| 2 | Small species, ♂ forewing 11–14 mm, markings pale yellow, colour contrast brilliant* | 3  |
| - | Larger species, ♂ forewing 15–18 mm, colour contrast slight or absent                | 4  |
| 3 | Forewing underside pale apical area unmarked   | <i>pictus</i> (p. 90)                              |
| - | Forewing underside apical area with linear markings                                  | <i>phaon</i> (p. 91)                               |
| 4 | Hindwing underside outer margin with dark shade in s2–s5                             | <i>tharos</i> (p. 85)                              |
| - | Hindwing underside marginal shade slight or absent                                   | 5  |
| 5 | Forewing upperside base dusky, yellow mark near apex of cell prominent               | 6  |
| - | Forewing upperside base rarely dusky, yellow mark near apex of cell not prominent    | <i>mylittus</i> (p. 88)                            |
| 6 | Forewing underside black costal and discal markings heavy                            | <i>batesii</i> (p. 86)                             |
| - | Forewing underside black costal and discal markings usually vestigial or absent      | <i>montanus</i> (p. 88), <i>campestris</i> (p. 87) |

***Phyciodes tharos* (Drury)**

(Figs 1, 178–182, 186–192)

*Papilio tharos* Drury, [1773]: index to vol. 1; [1770]: 43, pl. 21, figs 5, 6. Syntype(s), U.S.A.: New York (depository unknown) [not examined].

*Papilio morpheus* Fabricius, 1775: 530. Syntype(s), NORTH AMERICA ('in America boreali') (presumed lost; not listed by Zimsen, 1964).

*Papilio cocyta* Cramer, [1777]: 7, pl. 101, figs A, B. ♂ syntype(s), [NORTH AMERICA] ('Surinam') (presumed lost).

*Papilio euclea* Bergsträsser, 1780: 23, [pl. 79, figs 1, 2]. Holotype (sex?) [NORTH AMERICA] ('England') (*d'Orcy*) (depository unknown, presumed lost) [not examined].

\* In specimens of *P. phaon*, spring brood, colour contrast may be greatly reduced.

*Argynnis tharossa* Godart, [1819]: 289. ♂, ♀ syntypes, U.S.A.: New York, etc. (one syntype in RSM, Edinburgh; Grimshaw, 1898: 4). [There would be good grounds for considering this, and many other Godart names, as unjustified emendations; in this case, of *tharos* Drury, to which Godart includes a reference in his synonymy.]

*Melitaea tharos* (Drury); Boisduval & LeConte, 1833: 170, pl. 47, figs 3, 4.

*Melitaea selenis* Kirby, 1837: 289. Syntype(s), CANADA ('North America') (depository unknown; probably lost).

*Melitaea pulchella* Boisduval, 1852: 306. Syntypes, U.S.A.: [? New York] ('California') (not in BMNH). [See Tilden, 1970, concerning the type-material of this taxon.]

*Melitaea pharos* [sic!] (Drury); Harris, 1862: 289, figs 116, 117.

*Melitaea marcia* Edwards, [1869]: 207. Lectotype ♂, U.S.A.: New York, Hunter, Greene Co. (CM, Pittsburgh), designated by Brown (1966: 432, fig. 25).

*Melitaea packardii* Saunders in Packard, 1869: 256. Syntype(s), CANADA (depository unknown).

*Phyciodes pascoensis* Wright, 1906: 165, pl. 21, figs 198, a. Lectotype ♂, U.S.A.: E. Washington, Pasco (W. G. Wright) (CAS, San Francisco, Type no. 4308), designated by Tilden (1975: 23).

[*Phyciodes nycteis* (Doubleday); Wright, 1906: 164, pl. 21, fig. 197. Misidentification.]

*Phyciodes tharos* f. *reaghi* Reiff, 1913: 305, pl. 10, figs 1, 2. Holotype ♀, U.S.A.: Massachusetts, Franklin (A. L. Reagh) (depository unknown).

*Phyciodes tharos* (Drury); Röber, 1913: 436, pl. 89, row d [figs 1, 2]; Forbes, 1945: 154, 189; Holland, 1947: 135, pl. 18, figs 1-4, pl. 5, figs 20-22 (pupa).

*Phyciodes tharos pascoensis* f. *vern. herse* G. C. Hall, 1924: 110. Holotype ♀, CANADA: British Columbia, Taft (AMNH, New York).

*Phyciodes tharos pascoensis* f. *ab. nigrescens* G. C. Hall, 1924: 110. Holotype ♀, CANADA: British Columbia, Taft (AMNH, New York).

*Phyciodes tharos* tr. f. *dyari* Gunder, 1928: 167, fig. 18. Holotype ♂, U.S.A.: New Hampshire, Webster (USNM).

*Phyciodes tharos tharos* (Drury); Hall, 1928b: 35; Klots, 1951: 101, pl. 6, fig. 11 (pupa), pl. 13, fig. 14; Bauer, 1975: 144, pl. 44, figs 6, 8.

*Phyciodes tharos* f. *marcia* (Edwards); Hall, 1928b: 37.

*Phyciodes tharos arctica* dos Passos, 1935: 87; Forbes, 1945: 155; Klots, 1951: 101; Bauer, 1975: 144.

Holotype ♂, CANADA: Newfoundland, Port au Port, Table Mountain (G. C. Hall) (AMNH, New York).

*Phyciodes tharos pascoensis* Wright; Bauer, 1975: 144, pl. 77, figs 9, 10.

*Phyciodes tharos distincta* Bauer, 1975: 144. Syntype(s), U.S.A.: California, Calexico, Imperial Co. (depository not indicated).

♂ forewing 15-17 mm, upperside fulvous, markings black, without colour contrast, discal marks in s2 and s3 small or vestigial; hindwing fulvous discal band wide, the veins which cross the band not pigmented; underside with a prominent dark mark on outer margin between s2 and s5, often enclosing a pale lunule. ♀ similar, often larger.

*Genitalia*. In dorsal view, ♂ tegumen elongate, tapering slightly to rather wide apex, posterior border of juxta with central prominence. ♀, in dorsal view, sterigma deeply excavated, bursal duct firmly chitinised, bursal support rather long.

**DISTRIBUTION.** Widely distributed in North America, especially east of the Rocky Mountains; in Canada to 52°N., and southwards to Mexico.

**DISCUSSION.** There are two or more annual generations in suitable localities, with marked seasonal variation. In spite of wide distribution, regional (geographical) variation is slight, and Vawter & Brussard (1975) have recently commented on the apparent lack of geographical variability of various enzyme systems in this species. Oliver (1978a; 1978b; 1979) comments further on the genetics of this species, and reports on results from experimental hybridisations with *P. batesii* and *P. montanus*.

### *Phyciodes batesii* (Reakirt)

(Figs 2, 193)

[*Melitaea tharos* (Drury); Boisduval & Leconte, 1833: pl. 47, fig. 5. Misidentification.]

*Eresia batesii* Reakirt, 1865: 226. ♂, ♀ syntypes, U.S.A.: Virginia, Winchester; New Jersey, Gloucester, Reakirt Coll. (lost?).



*Phyciodes batesii* (Reakirt); Röber, 1913: 436, pl. 89, row d [fig. 5]; Hall, 1928b: 38; Forbes, 1945: 154, 189; Holland, 1947: 136, pl. 17, figs 35, 36; Klots, 1951: 100, pl. 13, fig. 12; Bauer, 1975: 145, pl. 44, fig. 9.  
*Phyciodes batesii* tr. f. *harperi* Gunder, 1932: 283. Holotype ♀, CANADA: Manitoba, McCreary, Gunder Coll. (present depository unknown).

♂ like *P. tharos* on both surfaces, but forewing underside black discal markings more extensive; hindwing underside yellow, faintly marked, dark shade along outer margin vestigial (if present). ♀ similar.

*Genitalia.* ♂ like *P. tharos*, in five specimens examined tegumen slightly more tapered, hooks closer together and more slender, probably within the range of normal variation.

**DISTRIBUTION.** E. Canada and NE. states of U.S.A., from Ontario and Quebec to Virginia and Nebraska, including New Jersey.

### *Phyciodes campestris* (Behr)

(Figs 4, 5, 194–202)

*Melitaea campestris* Behr, 1863: 86.

Like *Phyciodes tharos*, ♂ forewing 17 mm, variable, upperside black pattern more heavily marked, discal band yellow, paler than postdiscal bands, yellow mark present at cell-end; hindwing underside marginal lunule in s3 large, yellow or white.

*Genitalia.* Like *tharos*, ♂ in dorsal view, scaphial hooks usually slightly smaller. ♀ as in *tharos*.

**DISTRIBUTION.** Western regions of North America from Alaska southwards to Nevada and Mexico. Two subspecies with similar genitalia.

### *Phyciodes campestris campestris* (Behr)

(Figs 4, 194–199)

*Melitaea campestris* Behr, 1863: 86. ♀ syntypes, U.S.A.: California (various unstated localities) (destroyed by fire).

*Melitaea pratensis* Behr, 1863: 86. ♂ syntypes, U.S.A.: California, near San Francisco (destroyed by fire).

*Eresia campestris* (Behr); Reakirt, 1866a: 142.

[*Phyciodes orseis* (Edwards); Godman & Salvin, 1882: 193. Misidentification.]

*Phyciodes pratensis* (Behr); Röber, 1913: 436, pl. 89, row d [figs 3, 4].

*Phyciodes campestris* (Behr); Comstock, 1927: 116, pl. 39, figs 4–6; Holland, 1947: 137, pl. 17, figs 37, 38.

*Phyciodes campestris campestris* (Behr); Hall, 1929: 46; Forbes, 1945: 154–155, 189 (part); Bauer, 1975: 145, pl. 44, figs 10, 12.

As described above, colour contrast usually subdued.

**DISTRIBUTION.** Occurs especially in northern localities, Alaska, British Columbia etc., at moderate altitudes. The figure in 'Seitz' is too dark.

### *Phyciodes campestris camillus* Edwards

(Figs 5, 200–202)

*Phyciodes camillus* Edwards, 1871b: 268. Lectotype ♂, U.S.A.: Colorado, Fairplay, Park Co. (*Mead*) (CM, Pittsburgh), designated by Brown (1966: 451, fig. 30).

*Phyciodes emissa* Edwards, 1871b: 269. Lectotype ♀, U.S.A.: Colorado, Denver, Denver Co. (*Mead*) (CM, Pittsburgh), designated by Brown (1966: 453, fig. 31).

*Phyciodes camillus* ab. *rohweri* Cockerell, 1913: 308, fig. 1. Holotype, U.S.A.: Colorado, North Boulder Creek, Boulder County, Canadian Zone, viii. 1907 (*S. A. Rohwer*) (depository unknown).

*Phyciodes camillus* ab. *tristis* Cockerell, 1913: 308, fig. 2. Holotype, U.S.A.: Colorado, Jim Creek, Boulder County, 7. ix. 1907 (*S. A. Rohwer*) (depository unknown).

*Phyciodes camillus* Edwards; Röber, 1913: 437, pl. 89, row d [figs 7, 8]; Holland, 1947: 138, pl. 17, figs 32–34; Klots, 1951: 99, pl. 12, fig. 5.

*Phyciodes campestris* tr. f. *mcDunnoughi* Gunder, 1928: 167, figs 19, 19a. Holotype ♂, ? CANADA: 'T.N.W., Olds?' (CNC, Ottawa).

*Phyciodes campestris camillus* Edwards; Hall, 1929: 47; Forbes, 1945: 155; Bauer, 1975: 146, pl. 78, fig. 5.

♂ like *P. campestris campestris*, but upperside markings brighter, black pattern reduced and colour contrast often quite lively, with bands of red and yellow; hindwing underside usually greyish rather than yellow.

DISTRIBUTION. South-western states of U.S.A., especially Colorado and California, flying there at 2000–3000 m.

*Phyciodes montanus* (Behr) stat. rev.

(Figs 3, 203–208)

*Melitaea montana* Behr, 1863: 85. Syntypes, U.S.A.: California, Los Angeles; headwaters of Tuolumne River; Yosemite Valley (destroyed by fire).

*Melitaea orsa* Boisduval, 1869: 55. LECTOTYPE ♂, U.S.A.: California, 'Interior' (BMNH), here designated [examined]. [Lectotype figured by Oberthür, 1914: 81, fig. 2178.]

*Phyciodes montana* (Behr); Röber, 1913: 437, pl. 89, row e [fig. 3] (♂); Comstock, 1927: 116, pl. 39, figs 7, 8; Hall, 1929: 45; Holland, 1947: 138, pl. 17, figs 26, 27.

*Phyciodes campestris montanus* (Behr); Forbes, 1945: 155, 189; dos Passos, 1964.

*Phyciodes campestris montana* (Behr); Bauer, 1975: 145.

Like *P. campestris camillus* but slightly larger, ♂ forewing 16–18 mm, upperside black markings reduced, colours brighter. ♀ similar.

*Genitalia*. ♂ like *campestris*, in three specimens apical section of valve slightly shorter and more massive. Hall (1929: 46) also considered 'valve shorter than in *P. campestris*, the apical process less developed'.

DISTRIBUTION. Seen only from California, especially the Sierra Nevada; recorded flying at 2000–3000 m.

DISCUSSION. Dos Passos (1964), probably following Forbes (1945), included *montanus* with *P. campestris* as a subspecies. Hall (1929: 45) considered that *montanus* should have specific rank, and I agree that there are small distinctive characters in the male genitalia; further, the external characters are constant and recognisable. It is uncertain whether *P. campestris camillus* also flies with *montanus* at high levels in the Sierra Nevada, California.

*Phyciodes mylittus* (Edwards)

(Figs 6, 7, 209–211)

*Melitaea mylitta* Edwards, 1861: 160.

♂ forewing 16–20 mm, variable, outer margin usually slightly excavate. Upperside fulvous yellow, black pattern well defined, basal areas not suffused black; hindwing upperside fulvous, discal area unmarked, black postdiscal dots usually forming a complete series (6 dots). ♀ similar.

*Genitalia*. ♂ tegumen like *P. campestris*, but terminal lateral hooks smaller, more widely separated.

DISTRIBUTION. From S. Canada and British Colombia through the western states of U.S.A. to California (eastwards to foothills of the Rocky Mts.) to Mexico and Guatemala. Three subspecies with similar genitalia.

*Phyciodes mylittus mylittus* (Edwards)

(Figs 6, 209–211)

*Melitaea mylitta* Edwards, 1861: 160. Neotype ♂, U.S.A.: California, Stanyan Hill, San Francisco (CAS, San Francisco), designated by Brown (1966: 438, fig. 27).

*Melitaea collina* Behr, 1863: 86. Syntypes, U.S.A.: California, near San Francisco; hills of Contra Costa (? destroyed by fire).

*Melitaea epula* Boisduval, 1869: 54. LECTOTYPE ♂, U.S.A.: California, 'Interior' (BMNH), here designated [examined]. [Lectotype figured by Oberthür, 1914: 80, pl. 259, fig. 2176.]

- Phyciodes mylitta* (Edwards); Röber, 1913: 437, pl. 89, row e [fig. 1] (♂); Comstock, 1927: 117, pl. 39, figs 13–15; Forbes, 1945: 153, 189; Holland, 1947: 138, pl. 17, figs 40, 41; Tilden, 1970: 97.
- Phyciodes mylitta mylitta* (Edwards); Hall, 1928*b*: 42; Bauer, 1975: 149, pl. 16, figs 9, 10.
- Phyciodes mylitta* tr. f. *collinsi* Gunder, 1930: 62. Holotype ♂, U.S.A.: California, Collin's Ranch, Voltair, Gunder Coll. (present depository unknown).
- Phyciodes mylitta* ab. *macyi* Fender, 1930: 182. Holotype, U.S.A.: Oregon, McMinnville (*Fender*) (depository unknown).
- ? *Phyciodes mylitta arizonensis* Bauer, 1975: 149, pl. 43, fig. 8. Syntypes, U.S.A.: central & south-eastern Arizona; New Mexico, Sonora; south-western Colorado (depository not indicated).

♂ forewing usually small, 16–18 mm, described above.

FLIGHT. In lowland areas, occurs in a succession of broods from April to October, but double-brooded at altitudes of 2300 m or more.

DISTRIBUTION. Western states, from British Columbia to California, and east to foothills of the Rocky Mts. in Montana and Colorado. Guppy (1974) and Shepard (1977) discuss the apparently recent establishment of this species on Vancouver Island.

### *Phyciodes mylittus mexicanus* Hall

- Phyciodes mylitta mexicana* Hall, 1928*b*: 44. Holotype ♂, MEXICO: Jalapa (*Hoegel*) (BMNH) [examined].
- Phyciodes mylitta mexicana* Hall; Bauer, 1975: 150.

Both sexes like *P. m. mylittus*, but upperside fulvous ground colour slightly darker and all black markings slightly heavier.

FLIGHT. November, December, April, probably in two broods. Occurs at 1300 m or more.

DISTRIBUTION. Eastern Mexico.

### *Phyciodes mylittus thebais* Godman & Salvin

(Fig. 7)

- Phyciodes thebais* Godman & Salvin, 1878*a*: 267. Holotype ♂, MEXICO: Mountains of Oaxaca (*Fenocchio*) (BMNH, Type no. Rh. 8434; Gabriel, 1927: 118) [examined].
- Phyciodes thebais* Godman & Salvin; Godman & Salvin, 1882: 194, pl. 21, figs 13–15; Röber, 1913: 436.
- Phyciodes mylitta thebais* Godman & Salvin; Hall, 1928*b*: 44; Bauer, 1975: 150.

Like *P. mylittus mylittus*, ground-colour paler fulvous, almost obscured by greatly extended black markings. ♀ similar.

FLIGHT. Specimens dated April and July.

DISTRIBUTION. Western Mexico, Guatemala.

### *Phyciodes pallidus* (Edwards)

(Fig. 8)

- Melitaea pallida* Edwards, 1864: 505. Neotype ♀, U.S.A.: Colorado, Flagstaff Mt., Boulder Co. (CM, Pittsburgh), designated by Brown (1966: 443, fig. 28).
- Eresia mata* Reakirt, 1866*a*: 142. Syntype(s), U.S.A.: Rocky Mountains, Colorado Territory (Reakirt Coll.; lost?). **Syn. n.**
- Phyciodes barnesi* Skinner, 1897: 154. 'Many' ♂ syntypes, U.S.A.: Colorado, Glenwood Springs (*W. Barnes*) (CM, Pittsburgh).
- Phyciodes barnesi* Skinner; Röber, 1913: 436, pl. 89, row e [fig.2] (♂); Holland, 1947: 138, pl. 18, fig. 5 (type).
- Phyciodes mylitta barnesi* Skinner; Hall, 1928*b*: 43.
- Phyciodes mylitta pallida* (Edwards); Brown, 1966: 443.
- Phyciodes pallida pallida* (Edwards); Tilden, 1970: 96; Bauer, 1975: 148, pl. 44, fig. 5.
- Phyciodes pallida barnesi* Skinner; Tilden, 1970: 96; Bauer, 1975: 149, pl. 43, fig. 7, pl. 78, fig. 6.

♂ forewing 18–21 mm, upperside like *P. m. mylittus*, no constant distinctive external character except larger size. ♀ black markings sometimes extended.

*Genitalia.* ♂ like *P. m. mylittus*.

FLIGHT. Occurs as a single annual brood.

DISTRIBUTION. SW. Canada and Washington State southwards to Colorado and Arizona.

DISCUSSION. Larval and pupal characters are said to differ from those of *P. m. mylittus*.

*Phyciodes orseis* Edwards

(Fig. 212)

*Phyciodes orseis* Edwards, 1871a: 206. Lectotype ♂, U.S.A.: California, Napa County, Mt. St. Helena (Henry Edwards) (AMNH, New York), designated by Brown (1966: 450, fig. 29).

*Phyciodes orseis* Edwards; Röber, 1913: 436, pl. 89, row d [fig. 5]; Comstock, 1927: 117, pl. 39, figs 9–12; Hall, 1929: 48; Forbes, 1945: 153, 155, 189; Holland, 1947: 137, pl. 17, fig. 31 ('type'; designation rejected by Brown, 1966: 450); Scott, 1974 (early stages).

*Phyciodes orseis* tr. f. *edwardsi* Gunder, 1927: 135, pl. 2, fig. 5. Holotype ♀, U.S.A.: California, W. Barnes Coll. (present depository uncertain).

*Phyciodes orseis orseis* Edwards; Bauer, 1975: 147, pl. 43, fig. 6.

♂ forewing 20 mm, like *P. campestris*, upperside black pattern extensive, colour contrast usually present in pale areas. ♀ similar.

*Genitalia.* ♂ like *P. m. mylittus*.

DISTRIBUTION. Mountainous areas of western states of U.S.A. (coastal ranges), from Washington State to California.

DISCUSSION. The species is said to fly in association with *P. campestris* and *P. m. mylittus* (Scott, 1974), but separation from *campestris* may be extremely difficult.

*Phyciodes herlani* Bauer **stat. n.**

*Phyciodes (Phyciodes) orseis herlani* Bauer, 1975: 148, pl. 45, figs 9, 10. ♂, ♀ syntypes, U.S.A.: Nevada, Glenbrook Creek, Douglas Co. (depository not indicated).

Like *P. orseis* and *P. campestris*, upperside black markings greatly reduced, fulvous areas paler, colour contrast present but less striking. ♀ similar.

*Genitalia.* ♂ like *P. m. mylittus*.

DISTRIBUTION. California and Nevada (Douglas Co.), not rare at 2000 m or more.

*Phyciodes pictus* (Edwards)

(Figs 9, 213, 214)

*Melitaea picta* Edwards, 1865: 201.

♂ small, forewing 11–12 mm, like *P. campestris* but with colour contrast on upperside, cell-spot and discal spots pale yellow; underside apex bright yellow, usually unmarked; hindwing underside yellow, darker markings vestigial or absent. ♀ similar, often slightly larger.

*Genitalia.* Described below.

DISTRIBUTION. South-western states of U.S.A., and Mexico.

Two subspecies with slightly different genitalia.

*Phyciodes pictus pictus* (Edwards)

(Figs 9, 213)

*Melitaea picta* Edwards, 1865: 201. Lectotype ♂, U.S.A.: Nebraska, North Platte, Lincoln Co., (Ridings) (FMNH, Chicago), designated by Brown (1966: 457, fig. 32).

*Phyciodes canace* Edwards, 1871a: 206. Neotype ♂, U.S.A.: Arizona, nr Tucson, Pima Co. (*Morrison*) (CM, Pittsburgh), designated by Brown (1966: 461, fig. 331).

*Phyciodes picta* (Edwards); Röber, 1913: 437, pl. 89, row e [figs 4, 5]; Comstock, 1927: 118; Holland, 1947: 139; pl. 17, figs 20, 21.

*Phyciodes picta* ab. *jemezensis* Brehme, 1913: 194, pl. 7, figs 7, 8. Holotype ♂, U.S.A.: New Mexico, Jemez Springs, bred by J. Woodgate, Brehme Coll. (present depository unknown).

*Phyciodes picta picta* (Edwards); Hall, 1929: 49; Forbes, 1945: 154–155, 189; Brown, 1966: 455; Bauer, 1975: 146, pl. 44, fig. 11.

*Phyciodes picta canace* (Edwards); Brown, 1966: 457; Bauer, 1975: 147, pl. 16, fig. 11.

Upperside colour contrast very bright.

*Genitalia*. ♂ tegumen short, wide, terminal lateral hooks relatively large and strong. ♀ not examined.

**DISTRIBUTION.** U.S.A., southern states, from Arizona and Kansas southwards to N. Mexico (N. Sonora). Two broods, upperside black markings slightly heavier in first brood.

### *Phyciodes pictus pallescens* (Felder)

(Fig. 214)

*Eresia pallescens* Felder, 1869: 469. ♂, ♀ syntypes, MEXICO: Puebla, region of Cuernavaca (*Hedemann*) (NM, Vienna; BMNH) [3 ♂, 3 ♀ ? syntypes from Puebla in BMNH examined].

*Phyciodes pallescens* (Felder); Godman & Salvin, 1882: 195, pl. 21, figs 18, 19; 1901: 678; Röber, 1913: 437, pl. 89, row f [fig. 10] (♂).

*Phyciodes picta pallescens* (Felder); Hall, 1929: 50; Forbes, 1945: 154.

♂ like *P. pictus pictus*, upperside markings less brilliant, forewing underside apical area with vestigial markings; hindwing underside dark markings slightly indicated. ♀ similar.

*Genitalia*. ♂ like *P. pictus pictus* but tegumen perhaps slightly narrower in two preparations. The genitalia are minute and it is difficult to make a comparison.

**DISTRIBUTION.** According to Hall (1929: 50) this subspecies is restricted to central and southern Mexico.

**DISCUSSION.** *P. pallescens* is placed as a distinct species by some authors.

### *Phyciodes phaon* (Edwards)

(Figs 10, 215, 216)

*Melitaea phaon* Edwards, 1864: 505. Neotype ♂, U.S.A.: Georgia, St. Simon's Island, Glynn Co. (CM, Pittsburgh), designated by Brown (1966: 437, fig. 26).

*Phyciodes phaon* (Edwards), winter form ('aestiva'); Edwards, 1878 (descriptive term).

*Phyciodes phaon* (Edwards), summer form ('hiemalis'); Edwards, 1878 (descriptive term).

*Phyciodes phaon* (Edwards); Godman & Salvin, 1901: 677; Röber, 1913: 436, pl. 89, row c [figs 7, 8]; Comstock, 1927: 116, pl. 39, figs 1–3; Holland, 1947: 137, pl. 17, figs 22, 23; Bauer, 1975: 143, pl. 44, fig. 7; Riley, 1975: 79, pl. 12, fig. 18.

*Phyciodes phaon maya* Hall, 1928b: 41. Holotype ♂, GUATEMALA: Lake Amatitlan, 3800 ft [1260 m], October (BM, Brighton) [examined]. **Syn. n.**

*Phyciodes phaon phaon* (Edwards); Hall, 1928b: 40.

*Phyciodes phaon phaon* f.t. 'aestiva'; Hall, 1928b: 40.

*Phyciodes phaon* f. *phaon*; Forbes, 1945: 154.

*Phyciodes phaon* f. 'hiemalis'; Forbes, 1945: 154; Brown, 1966: 464.

*Phyciodes phaon* f. 'aestiva'; Brown, 1966: 464.

♂ forewing 11–13 mm, upperside like *P. pictus*, but colour contrast less brilliant, post-discal band from s1b–s4 often fulvous in spring brood but in later broods bright yellow and very prominent, forewing underside apex with usual marginal and submarginal markings; hindwing underside all markings well defined, ground colour greyish in early brood, pale cream in later broods. ♀ similar.

*Genitalia*. ♂ like *P. pictus*, in dorsal view not quite so wide, terminal hooks very robust; penis slender. ♀ not examined.

DISTRIBUTION. U.S.A. (all southern states), Cayman Islands, Mexico, Guatemala, British Honduras. Recorded from Cuba (Riley, 1975). Flies in two or three annual broods, with marked seasonal variation.

*Phyciodes vesta* (Edwards)

(Figs 11, 217, 218)

*Melitaea vesta* Edwards, 1869: 371.

♂ small, forewing 13–14 mm, upperside like *P. phaon*, but without colour contrast and yellow markings; hindwing underside markings well defined, especially postdiscal macular band. ♀ similar.

*Genitalia*. ♂ distinctive; tegumen short, massive, two hooks at each angle of scaphial extension, additional short hook sometimes present. ♀ bursal duct short, chitinised, scutum large.

DISTRIBUTION. Local but widely distributed in south-western states of U.S.A., Guerrero in Mexico, Guatemala.

Two subspecies, with similar genitalia.

*Phyciodes vesta vesta* (Edwards)

(Figs 11, 217, 218)

*Melitaea vesta* Edwards, 1869: 371. Neotype ♂, U.S.A.: Texas, Neu Braunfels, Comal Co. (CM, Pittsburgh), designated by Brown (1966: 463, fig. 34).

*Phyciodes boucardi* Godman & Salvin, 1878a: 268. Holotype ♂, MEXICO: Putla (*Rébouch*) (BMNH Type no. Rh. 8438; Gabriel, 1927: 23) [examined].

*Phyciodes vesta* (Edwards); Godman & Salvin, 1882: 195; 1901: 678; Röber, 1913: 436, pl. 89, row c [fig. 5]; Hall, 1929: 50; Forbes, 1944; Holland, 1947: 136, pl. 17, figs 17–19; Bauer, 1975: 142, pl. 45, fig. 14.

*Phyciodes boucardi* Godman & Salvin; Godman & Salvin, 1882: 194, pl. 21, figs 16, 17; 1901: 678 (gen. 2); Röber, 1913: 437, pl. 89, row e [figs 8, 9].

*Melitaea arida* Skinner, 1917: 328. Holotype, U.S.A.: Arizona, Cochise Co. (*F. Haimbach*) (CM Pittsburgh).

*Phyciodes vesta vesta* (Edwards); Hall, 1929: 51.

[? *Phyciodes thebais* Godman & Salvin; Holland, 1947: 137, pl. 59, fig. 22. Misidentification.]

The markings of the upperside are regular and complete.

DISTRIBUTION. South-western states of U.S.A., Northern Mexico. Flies in two annual broods, the summer brood (gen. 2, f. *boucardi*) has the underside hindwings heavily marked with purplish brown.

*Phyciodes vesta graphica* (Felder)

*Eresia graphica* R. Felder, 1869: 470. ♂, ♀ syntypes, MEXICO: Huahuapan, *Hedemann* (NM, Vienna ?).

*Phyciodes vesta vestalis* Hall, 1929: 52. Holotype ♂, GUATEMALA (BM, Brighton) [examined]. *Syn. n.* [*Phyciodes vesta vesta* (Edwards); Hall, 1929: 51, in part. Misidentification.]

♂ slightly larger than nominate *P. vesta*, upperside tone of fulvous ground colour more intense and black markings slightly extended.

DISTRIBUTION. S. Mexico and Guatemala, doubtfully recognisable as a valid subspecies.

DISCUSSION. *Eresia graphica* was described by R. Felder from specimens collected at Huahuapan by Hedemann; these are presumed to be in the NM, Vienna. A male from 'Cuernavaca', ex Felder Coll., is now in the BMNH and bears Felder's determination label '*Eresia graphica* Feld.', and an ex Rothschild 'type' label. However, it seems doubtful that this specimen is part of the original type-series, although it was possibly in the Felders' collection at the time of description.

***PHYSTIS* gen. n.**

Type-species: *Eresia simois* Hewitson. Gender: feminine.

Small butterflies, wings broad, forewing outer margin convex. Upperside brown, markings small yellow spots arranged across the wings in regular transverse series; on hindwing upperside each spot of the postdiscal series encloses a small blind pupil.

*Genitalia.* ♂ tegumen in dorsal view short, wide, slightly chitinized, scaphial extension vestigial, posterior border of juxta gently convex or almost straight, saccus deeply cleft, posterior section of valve terminating in a simple, incurved pointed apex, harpe slightly variable; penis slender, probably lacking ostium-keel. ♀ genitalia unusually simple, in dorsal view ostium bursae exposed, the duct not chitinized, sterigma shallow, the cup-shaped bursal support arising very close to ostium, post-vaginal scutum large.

**DISTRIBUTION.** Brazil, Argentina, Uruguay, Bolivia, Paraguay, NE. Peru.

**DISCUSSION.** The genus includes a single divergent and very variable species, with wing markings which suggest relationship with the *Phyciodes* of North America. This is not confirmed by the genitalia, which are distinctive, especially those of the female, and unlike those of any other species.

***Phystis simois* (Hewitson) comb. n.**

(Figs 12, 13, 219–223)

*Eresia simois* Hewitson, [1864].

Size very variable, ♂ forewing 10–15 mm, upperside markings yellow to cream, prominent or greatly reduced in size by extension of the brown ground colour. On underside of forewing a black postdiscal mark is characteristic and usually prominent. On hindwing upperside a postdiscal series of ocellar spots recalls *Phyciodes tharos* and its allies.

*Genitalia.* See generic description. The organs are very small. In a series of seven preparations I have not found any consistent variation to suggest separation into two species. The variation observed has been due, probably, to small differences in rotation of the parts within the mountant.

**DISTRIBUTION.** Widely distributed in Brazil, extending southwards to N. Argentina and westwards to Peru, Uruguay and Bolivia.

Two subspecies.

***Phystis simois simois* (Hewitson)**

(Figs 12, 219, 220)

*Eresia simois* Hewitson, [1864]: [21], pl. [11], figs 30, 31. LECTOTYPE ♀, BRAZIL (BMNH, Type no. Rh. 8435), here designated [examined].

*Phyciodes pedrona* Moulton, 1909: 103. Holotype ♂, BRAZIL: 'Minas Gerães, Discoberto, near João Pedro's house' (*W. J. Burchell*) (UM, Oxford, Type no. 1149) [examined]. **Syn. n.**

*Phyciodes pedrona* Moulton; Röber, 1913: 436.

*Phyciodes simois simois* (Hewitson); Hall, 1929: 53.

*Phyciodes simois pedrona* Moulton; Hall, 1929: 53.

*Phyciodes (Tritanassa) simois* (Hewitson); Forbes, 1945: 189.

*Phyciodes (Tritanassa) pedrona* Moulton; Forbes, 1945: 189.

♂ forewing 10–11 mm, usually very small, upperside yellow markings at base and in cell obscured by extension of brown ground colour, but with an oblique discal series of small yellow spots rather better defined; hindwing upperside markings small and regular; underside bright yellowish brown, on forewing a wide, black, postdiscal area extends from costa to inner margin, with white spots, as on upperside, very prominent. ♀ similar, but larger.

**DISTRIBUTION.** N. Brazil: Pernambuco, Bahia, etc.

*Phystis simois variegata* (Röber)

(Figs 13, 221–223)

*Phyciodes variegata* Röber, 1913: 437, pl. 89, row f [fig. 3] (♂). Holotype ♂, ARGENTINA: La Soledad, Prov. Entre Rios (*E. A. Britton*) (BMNH) [examined].

*Phyciodes simois* ab. *nigrina* Hayward, 1931: 51, pl. 11, fig. 10. Holotype ♂, ARGENTINA: Prov. Córdoba, Yacanto (Breyer Coll.; present depository unknown).

*Phyciodes simois variegata* Röber; Hall, 1929: 53.

*Phyciodes simois pratti* Hall, 1935: 221. Holotype ♂, PERU: W. slopes of Andes, 4000 ft [1330 m] (BM, Brighton) [examined]. **Syn. n.**

*Phyciodes pedrona variegata* Röber; Hayward, 1952: 290; 1964b: 342, pl. 18, fig. 6.

♂ forewing 13–15 mm, variable, upperside with yellow spots in pattern similar to *simois simois* but larger, postdiscal costal bar of 4 macules prominent and spots in s1b, s2 and s3 enlarged, forming with the costal bar, a broken band across the wing; forewing underside black postdiscal area reduced, spots usually yellow (not white), submarginal area with single spot in s3; hindwing underside pale buff, markings vestigial, if present. ♀ usually slightly larger, markings also larger and paler.

**DISTRIBUTION.** Brazil, especially in southern regions, N. Argentina, Uruguay, Bolivia, Peru.

**DISCUSSION.** The two subspecies, as described, represent the extremes of a well-defined cline. The geographical limits of *simois simois* are found in northern Minas Gerais, and from there southwards through C. and S. Brazil there are larger forms with intermediate characters, often difficult to place with one or other of the recognised subspecies. In Argentina and in Uruguay *simois variegata* is fully developed. The species is represented in the BMNH by occasional specimens from Bolivia and Peru, but the material is very scanty and insufficient to show local character.

The ♂ holotype of *Phyciodes pedrona* Moulton is very small and in my view is referable to nominate *simois*. On the forewing upperside the yellow discal spots are slightly more prominent than usual. A single paratype in the BMNH has similar characters.

*ANTHANASSA* Scudder

*Anthanassa* Scudder, 1875: 239, 268. Type-species: *Melitaea texana* Edwards, by subsequent designation [= *Eresia cincta* Edwards, by original designation. Misidentification] (see ICZN, 1967, *Bull. zool. Nom.* 24: Opinion 839: 337). Gender: feminine.

*Tritanassa* Forbes, 1945: 171 (as subgenus of *Phyciodes*). Type-species: *Eresia drusilla* Felder & Felder, by original designation. **Syn. n.**

Butterflies of less than median size, forewing apex often truncate, outer margin excavate. On uppersides all species are black or dark brown with white or yellow markings arranged in a characteristic pattern, on forewing rounded white or yellow submarginal spots in s1b and s4 are constant, making a useful generic character; hindwing upperside with a transverse or slender discal band, and a series of submarginal and marginal lunules present in most species. Sexes similar, or nearly so.

**Genitalia.** In most species ♂ tegumen is little chitinised, scaphial extension often extremely fragile, membranous; valve apex slender, preapical tooth well developed, so that the apex appears to be bifid in dorsal view (Fig. 229); saccus deeply cleft; penis slender with a small morula, ostium keel absent. ♀ bursal duct short, bursal support usually small but well defined.

In *A. drusilla* and the 11 species which follow it in this work, the genitalia are uniform, but good specific characters are present in the genitalia of the seven remaining species.

**DISTRIBUTION.** The genus is well developed in Mexico, Central America and western South America, from Venezuela and Colombia to Bolivia, in mountainous regions. It is represented in eastern regions, including Brazil, Paraguay and northern Argentina, by one species, *A. hermas*.

A single species, *A. frisia*, occurs in Jamaica, Cuba and in other islands of the Greater Antilles. The species are not mimetic.



Key to species of *Anthanassa*

- 1 In dorsal view, lateral walls of scaphial extension dentate (Fig. 255) . . . . . 2  
 - In dorsal view scaphial walls not dentate . . . . . 6
- 2 Spiny area of scaphium in a wide band (Fig. 255) . . . . . *hermas* (p. 104)  
 - Spines confined to lateral walls of scaphium (Fig. 258) . . . . . 3
- 3 Upperside markings very pale on dark grey-brown . . . . . *tulcis* (p. 105)  
 - Upperside markings fulvous or yellow . . . . . 4
- 4 Upperside markings yellow on medium-brown . . . . . *dubia* (p. 106)  
 - Upperside markings fulvous . . . . . 5
- 5 Hindwing upperside prediscal band short . . . . . *frisias* (p. 105)  
 - Hindwing upperside prediscal band well developed . . . . . *taeniata* (p. 106)
- 6 Valve apex with 2 or 3 prominent teeth . . . . . 7  
 - Valve apex appears bifid . . . . . 10
- 7 Valve apical teeth short . . . . . *sosis* (p. 106)  
 - Valve medial apical tooth long . . . . . 8
- 8 Underside forewing base bright orange . . . . . *sitalces* (p. 107)  
 - Underside forewing base grey-brown . . . . . 9
- 9 Valve apex medial tooth very long (Fig. 267) . . . . . *drymaea* (p. 107)  
 - Valve apex medial tooth shorter (Fig. 269) . . . . . *cortes* (p. 107)
- 10 Hindwing upperside transverse band well-defined . . . . . 11  
 - Hindwing upperside transverse band obscure or absent . . . . . 17
- 11 Hindwing upperside transverse band yellow . . . . . 12  
 - Hindwing upperside transverse band white . . . . . 15
- 12 Band wide at outer margin, tapering rapidly . . . . . 13  
 - Hindwing not so marked . . . . . 14
- 13 ♂ forewing 19 mm, single spot in s1b, hindwing underside pallid buff, markings obscure . . . . . *dracaena* (p. 99)  
 - ♂ forewing 17 mm, two spots in s1b, hindwing underside markings brighter, grey and brown . . . . . *phlegias* (p. 99)
- 14 Hindwing upperside marginal lunules of even size . . . . . *drusilla* (p. 96)  
 - Hindwing upperside marginal lunules enlarged in s6 and s7 . . . . . *ptolyca* (p. 97)
- 15 Forewing base orange-red . . . . . *texana* (p. 99)  
 - Forewing not so marked . . . . . 16
- 16 Forewing upperside markings yellowish . . . . . *alexon* (p. 100)  
 - Forewing markings white on black . . . . . *ardys* (p. 98)
- 17 Forewing upperside with large orange costal mark, other markings vestigial or absent . . . . . *fulviplaga* (p. 104)  
 - Forewing not so marked . . . . . 18
- 18 Forewing upperside with orange postdiscal oblique band . . . . . *crithona* (p. 104)  
 - Forewing not so marked . . . . . 19
- 19 Hindwing upperside gleaming blue-black, marginal border black, otherwise unmarked . . . . . 20  
 - Hindwing upperside not so marked . . . . . 21
- 20 Forewing upperside with yellow markings in pattern like *drusilla* . . . . . *otanes sopolis* (p. 103)  
 - Upperside markings greatly reduced or absent . . . . . *otanes otanes* (p. 103)
- 21 Upperside hindwing dark brown, markings vestigial, if present . . . . . 22  
 - Upperside hindwing postdiscal markings combine to form a series of ocelliform circles . . . . . 23
- 22 Forewing upperside discal area chestnut-brown . . . . . *argentea* (p. 102)  
 - Forewing upperside very dark, markings obscure if present . . . . . *atronia* (p. 102)
- 23 Forewing upperside dark brown, markings vestigial if present . . . . . *acesas* (p. 101)  
 - Forewing upperside markings well developed . . . . . 24
- 24 Hindwing upperside yellow discal band obscure, divided into macules by dark veins . . . . . *nebulosa* (p. 101)  
 - Hindwing upperside discal band absent . . . . . *annulata* (p. 103)

*Anthanassa drusilla* (Felder & Felder) **comb. n.**

(Figs 14–16, 224–228)

*Eresia drusilla* Felder & Felder, 1861: 103.

♂ forewing size variable, 14–17 mm, upperside dark brown, markings orange-fulvous to yellow-buff, individually and locally variable; hindwing upperside pale discal band present, usually with postdiscal and submarginal spots and lunules. ♀ slightly larger, with similar markings.

*Genitalia.* ♂ in dorsal view, tegumen short, membranous, extremely fragile; posterior border of juxta wide, concave or slightly wavy, lateral angles prominent. ♀ ductus chitinised, short, bursal support shallow, post-vaginal scutum extensive.

**DISTRIBUTION.** From Mexico across central and western South America to Peru, Ecuador and Bolivia.

Four subspecies, all with similar genitalia.

*Anthanassa drusilla drusilla* (Felder & Felder)

(Figs 14, 224–228)

*Eresia drusilla* Felder & Felder, 1861: 103. **LECTOTYPE** ♂, VENEZUELA (*Moritz*) (BMNH, specimen bears original label of Felders' inscribed 'drusilla H.-S.', locality data, and 'type') here designated [examined]. (A specimen labelled BM Type no. Rh. 8447 and listed by Gabriel, 1927: 42, is a ♀ paralectotype.)

*Phyciodes flavimacula* Röber, 1913: 442, pl. 90, row c [fig. 2] (♀). **LECTOTYPE** ♂, COLOMBIA: Coreato, Cauca Valley (*Paine & Brinkley*) (BMNH, specimen bears Röber's determination label, and is also labelled 'type') here designated [examined].

*Phyciodes drusilla drusilla* (Felder & Felder); Hall, 1929: 86.

♂ forewing 15–16 mm, variable, upperside markings bright orange-fulvous, hindwing underside pale discal band usually prominent. ♀ usually larger, upperside markings slightly paler, vague basal markings often present on forewing upperside.

**DISTRIBUTION.** Venezuela, Colombia, Ecuador, Panama (rare).

*Anthanassa drusilla lelex* (Bates)

*Melitaea lelex* Bates, 1864a: 82. **LECTOTYPE** ♂, PANAMA: Lion Hill (*McLeannan*) (BMNH, Type no. Rh. 8445; Gabriel, 1927: 72), here designated [examined].

*Melitaea alethes* Bates, 1864a: 82. **LECTOTYPE** ♂, GUATEMALA: Central Valleys (*Godman & Salvin*) (BMNH Type no. Rh. 8443; Gabriel, 1927: 9), here designated [examined].

*Melitaea stesilea* Bates, 1864a: 82. **LECTOTYPE** ♀, GUATEMALA: interior (BMNH Type no. Rh. 8444; Gabriel, 1927: 113), here designated [examined]. [♀ of f. *alethes*.]

[*Phyciodes ptolyca* (Bates); Godman & Salvin, 1882: 201, pl. 21, fig. 34 (♀), fig. 35 (♂ underside), fig. 36 (♂ underside). Misidentification.]

[*Phyciodes ptolyca* (Bates); Röber, 1913: pl. 90, row b [fig. 3] (♂), [fig. 4] (♂). Misidentification.]

*Phyciodes drusilla lelex* (Bates); Hall, 1929: 88.

*Phyciodes drusilla alethes* (Bates); Hall, 1929: 88.

♂ upperside like *A. drusilla drusilla* but markings paler, ochre-yellow or buff. In some districts postdiscal and submarginal markings become less distinct (f. *alethes*). ♀ similar, markings often pale.

**DISTRIBUTION.** Mexico and Central America, widely distributed, with transition zone to nominate *drusilla* in Panama, with minor local variation.

*Anthanassa drusilla alceta* (Hewitson)

(Fig. 15)

*Eresia alceta* Hewitson, 1869a: 28, [index]. **LECTOTYPE** ♂, ECUADOR: Rio Verde (*Buckley*) (BMNH, Type no. Rh. 8454; Gabriel, 1927: 9), here designated [examined]. [Incorrectly identified and labelled ♀ by Hewitson.]

*Phyciodes flavimacula conflua* Röber, 1913: 442, pl. 90, row c. Syntype(s), PERU: Chanchamayo (depository unknown).

*Phyciodes drusilla alceta* (Hewitson); Hall, 1929: 89.

♂ like *A. drusilla drusilla*, forewing 16–18 mm, upperside markings orange-fulvous, postdiscal costal bar and discal spots fused to form a band 2–3 mm wide; hindwing upperside fulvous discal band 3 mm wide, veins crossing band little, if at all, darkened.

DISTRIBUTION. Ecuador, N. Peru. The distribution of this rather striking form appears to be well defined, but Hall records intermediate specimens grading into nominate *drusilla*.

*Anthanassa drusilla verena* (Hewitson)

(Fig. 16)

*Eresia verena* Hewitson, [1864]: [20], pl. [10], figs 27, 28. LECTOTYPE ♂, BOLIVIA (BMNH, Type no. Rh. 8455; Gabriel, 1927: 122), here designated [examined].

*Phyciodes verena* (Hewitson); Röber, 1913: 440, pl. 90, row a [fig. 1] (♂).

*Phyciodes drusilla verena* (Hewitson); Hall, 1929: 89.

♂ forewing 16–17 mm, upperside like *drusilla drusilla*, orange-fulvous discal band complete from costa to inner margin, 2–3 mm wide; hindwing upperside postdiscal area clear orange-fulvous, 3–4 mm wide. ♀ larger, forewing 19 mm, upperside markings slightly paler and more extensive.

DISTRIBUTION. Bolivia. This striking form appears to be uncommon but constant where it occurs.

*Anthanassa ptolyca* (Bates) **comb. n.**

(Figs 17, 229, 230)

*Melitaea ptolyca* Bates, 1864a: 81.

Like *Anthanassa drusilla*, ♂ forewing 15–18 mm, upperside markings yellow to white, hindwing postdiscal markings vestigial or absent, submarginal lunules present, enlarged in s7 and s8. ♀ larger, markings usually extended.

*Genitalia*. ♂ in dorsal view like *A. drusilla*, slightly less massive, tegumen often better defined, scaphial extension tapering. ♀ bursal support small, scutum very large.

DISTRIBUTION. From Mexico southwards through Central America to Venezuela.

Two subspecies or clinal forms.

*Anthanassa ptolyca ptolyca* (Bates)

(Figs 17, 229, 230)

*Melitaea ptolyca* Bates, 1864a: 81. LECTOTYPE ♂, GUATEMALA: Chisoy Valley (*Godman & Salvin*) (BMNH, Type no. Rh. 8448; Gabriel, 1927: 101), here designated [examined].

*Phyciodes ptolyca* (Bates); *Godman & Salvin*, 1882: pl. 21, fig. 32 (♂), fig. 33 (♂ underside), fig. 34 (♀ underside).

*Phyciodes carrera* Hall, 1917: 162. LECTOTYPE ♂, GUATEMALA: L. Amatitlan, 4000 ft [1330 m] (BM, Brighton), here designated [examined]. [Specimen bears Hall's ms type label.]

*Phyciodes ptolyca ptolyca* (Bates); Hall, 1929: 92.

Upperside markings bright orange-yellow in both sexes, ♂ forewing underside base yellow; hindwing discal band well-defined.

DISTRIBUTION. Mexico, Guatemala, Nicaragua, Venezuela.

*Anthanassa ptolyca amator* (Hall)

*Phyciodes ptolyca amator* Hall, 1929: 92. Holotype ♂, MEXICO: Venta de Zopilote, Guerrero, 2800 ft [930 m], (*H. H. Smith*) (BMNH) [examined].

Upperside markings pale yellow to cream-white, hindwing discal band narrow; underside forewing base pale yellow-brown.

DISTRIBUTION. Western Mexico, flying at altitudes of 600–1800 m.

DISCUSSION. The status of this form is uncertain since all specimens in the BMNH, and in the BM, Brighton (Hall Coll.), came from a single locality.

*Anthanassa ardys* (Hewitson) **comb. n.**

(Figs 18, 19, 231–233)

*Eresia ardys* Hewitson, [1864]: [22].

♂ forewing 16–19 mm, upperside black with small white markings, which include a cell-spot slightly before cell-end, and a small submarginal spot in s3, vestiges of yellowish basal striae sometimes present; hindwing upperside discal band white; hindwing underside variable, marbled in grey, pale and dark brown.

♀ larger, upperside markings cream-white, usually expanded, wing-bases with obscure yellowish striations.

*Genitalia*. ♂ like *Anthanassa drusilla*, tegumen better defined, posterior border of juxta gently concave, penis slender. ♀ not examined.

DISTRIBUTION. From S. Mexico through Central America to Colombia.

Two subspecies with similar genitalia.

*Anthanassa ardys ardys* (Hewitson)

(Figs 18, 231, 232)

*Eresia ardys* Hewitson, [1864]: [22], pl. [11], figs 35, 36. LECTOTYPE ♂, MEXICO: Orizaba (BMNH, Type no. Rh. 8442; Gabriel, 1927: 15), here designated [examined].

? *Eresia genigueh* Reakirt, 1865: 225. Syntype(s) ♂, U.S.A.: Los Angeles, California (Reakirt Coll.; present depository unknown). [Treated by Hall, 1929: 90, as a synonym of *ardys ardys*, without comment; if this is correct, the type-locality given by Reakirt must be in error—if not, then Hall's synonymy must be in error!]

*Phyciodes ardys ardys* (Hewitson); Hall, 1929: 90.

♂ forewing upperside cell-spot vestigial; hindwing upperside white discal band narrow, 1–2 mm wide, slightly sinuous, broken by black veins, series of slender submarginal lunules complete. ♀ underside hindwing white discal stripe narrow and irregular if present.

DISTRIBUTION. S. Mexico, Nicaragua, Costa Rica, Colombia.

*Anthanassa ardys subota* (Godman & Salvin)

(Figs 19, 233)

*Phyciodes subota* Godman & Salvin, 1878a: 268. LECTOTYPE ♂, GUATEMALA: Polochic Valley (Godman & Salvin) (BMNH, Type no. Rh. 8505; Gabriel, 1927: 114), here designated [examined].

*Phyciodes subota* Godman & Salvin; Godman & Salvin, 1882: 204, pl. 22, figs 7, 8.

*Phyciodes ardys subota* Godman & Salvin; Hall, 1929: 91.

Usually slightly larger in overall size than *ardys ardys*; upperside markings milk-white, slightly larger, cell-spot larger, wing bases black; hindwing upperside white discal band wider, 2 mm, veins less heavily marked, submarginal lunules absent; hindwing underside with white discal band prominent.

*Genitalia*. ♂ in dorsal view, posterior section of valve more elongate (single preparation).

DISTRIBUTION. Guatemala (Polochic Valley), Costa Rica.

DISCUSSION. *A. ardys subota* appears to be a constant form, and widely distributed in Guatemala. Its taxonomic position is a little uncertain as *A. ardys ardys* occurs in neighbouring countries, but an overlap of distribution has not been recorded. Hall (1929: 91) states that *A. ardys ardys* does not occur in Guatemala. The figure in Godman & Salvin (1882: pl. 22, fig. 7) is considerably enlarged (forewing 20 mm) compared with the actual specimen, now preserved in the BMNH.

*Anthanassa dracaena* (Felder & Felder) **comb. n.**

(Figs 20, 234–236)

*Eresia dracaena* Felder & Felder, 1867: 393. LECTOTYPE ♂, COLOMBIA: 'Bogota' (Lindig) (BMNH), here designated [examined]. [Specimen bears Felders' original ms label.]

*Phyciodes dracaena* (Felder & Felder); Röber, 1913: 442, pl. 90, row c [fig. 3] (underside).

*Phyciodes dracaena dracaena* (Felder & Felder); Hall, 1929: 100, pl. 1, fig. 11 (♂).

♂ forewing 19 mm, elongate, upperside dark brown, markings orange, like *Anthanassa drusilla* but with oblique mark before cell-end and lacking proximal orange spot in s1b; hindwing underside very pale buff, markings not well defined, basal area with irregular markings limited by broken brown discal line (most prominent on the costa), outer margin orange-brown from s5 to anal angle. ♀ similar, forewing 20 mm, markings white, hindwing upperside discal band faintly yellow.

*Genitalia.* ♂ like *A. drusilla*, tegumen and scaphial extension better defined, posterior border of juxta almost straight, valve apex and harpe more slender. ♀ sterigma not large, ductus lightly chitinized, bursal support large, cylindrical, a most distinctive feature, post-vaginal scutum extensive.

DISTRIBUTION. Colombia, not recorded elsewhere.

*Anthanassa phlegias* (Godman & Salvin) **comb. n., stat. rev.**

(Fig. 21)

*Phyciodes phlegias* Godman & Salvin, 1901: 680, pl. 108, figs 21, 22. LECTOTYPE ♂, HONDURAS (BMNH, ex Staudinger, ex Godman & Salvin Coll.; Type no. Rh. 8502; Gabriel, 1927: 97), here designated [examined].

*Phyciodes carigia* Schaus, 1902: 395. Holotype (sex ?), COLOMBIA (USNM, Type no. 5889).

*Phyciodes carigia* Schaus; Schaus, 1913: 346, pl. 50, fig. 9 (♀).

*Phyciodes platyaenia* Röber, 1913: [no text] pl. 90, row b [fig. 5] (♂). Syntype(s) ♂, [HONDURAS] (depository unknown).

*Phyciodes dracaena phlegias* Godman & Salvin; Hall, 1929: 100.

♂ forewing 17 mm, like *Anthanassa dracaena* but smaller, outer margin deeply excavate, upperside markings orange-fulvous as in *Anthanassa drusilla*, but wing-base dark, spot at base of space 1b present; hindwing uppermost orange discal band wide, tapering to inner margin, submarginal lunules well defined but narrow postdiscal band absent; hindwing underside discal band grey, brightly marked, expanded at outer margin, brown costal mark conspicuous.

*Genitalia.* Not examined.

DISTRIBUTION. Honduras (1 ♂), Costa Rica (1 ♂). A rare species.

*Anthanassa texana* (Edwards)

(Figs 22, 237–239)

*Melitaea texana* Edwards, 1863: 81.

♂ forewing 18–19 mm, outer margin deeply scalloped, upperside dark brown, markings small white spots, small spot in cell near apex, another in s2 near base; hindwing upperside white discal band narrow, crossed by dark veins, small orange spot in cell; forewing underside base orange-red; hindwing white discal band not prominent, marginal area strongly marbled in grey, light and dark brown. ♀ larger, markings similar, upperside with confused orange basal markings more prominent.

*Genitalia.* ♂ like *Anthanassa drusilla*, in dorsal view narrower, valve apex more slender, harpe less massive. ♀ like *A. drusilla*.

DISTRIBUTION. Southern States of U.S.A., from Arizona and Texas to N. Mexico and eastwards to Georgia and Florida.

Two subspecies with similar genitalia.

*Anthanassa texana texana* (Edwards)

(Figs 22, 237-239)

*Melitaea texana* Edwards, 1863: 81. ?Holotype ♂, U.S.A.: Texas [New Braunfels, Comal Co.] (CM, Pittsburgh) (see Brown, 1966: 421, fig. 22).

*Eresia smerdis* Hewitson, [1864]: [21], pl. [11], figs 33, 34. LECTOTYPE ♂, MEXICO (BMNH, type no. Rh. 8497; Gabriel, 1927: 112), here designated [examined].

[*Eresia cincta* Edwards; Scudder, 1875: 239, 268. Misidentification.]

*Phyciodes texana* (Edwards); Röber, 1913: 442, pl. 90, row c [fig. 5] (♂), [fig. 6] (♀).

*Anthanassa texana* (Edwards); Barnes & McDunnough, 1917: 10; Holland, 1947: 141, pl. 18, figs 8, 9.

*Phyciodes texana texana* (Edwards); Hall, 1929: 96.

*Phyciodes texana* (Edwards); Forbes, 1945: 178.

♂ forewing upperside wing bases brown with obscure orange markings.

DISTRIBUTION. U.S.A.: Arizona, Texas, New Mexico, Nebraska; Mexico.

*Anthanassa texana seminole* (Skinner)

*Eresia texana seminole* Skinner, 1911: 412. ♂, ♀ syntypes, U.S.A.: Bainbridge, Georgia (CM, Pittsburgh).

*Anthanassa texana* var. *seminole* Skinner; Holland, 1947: 141, pl. 59, fig. 14 (♂).

Differs from *A. texana texana* on upperside, bases of both wings being orange-red.

DISTRIBUTION. Only south-east U.S.A.: Florida, Georgia.

DISCUSSION. There is little information about this butterfly; its status as a subspecies needs confirmation.

*Anthanassa alexon* (Godman & Salvin) comb. n., stat. rev.

(Figs 23, 240)

*Phyciodes alexon* Godman & Salvin, 1889: 353.

Like *Anthanassa texana*, ♂ forewing 17-19 mm, upperside dark brown, markings white or yellowish; forewing underside base yellow-grey; hindwing underside with triangular, brown costal mark, other markings indistinct. ♀ larger, markings similar.

*Genitalia*. Like *A. ardys*, ♂ differs slightly in shape of tegumen and in bilobed scaphial extension, posterior border of juxta with central prominence. ♀ not examined.

DISTRIBUTION. Arizona, Mexico (Guerrero).

Two subspecies with similar genitalia.

*Anthanassa alexon alexon* (Godman & Salvin)

(Fig. 23)

*Phyciodes alexon* Godman & Salvin, 1889: 353. LECTOTYPE ♂, MEXICO: Cuernavaca, Morelos (*H. H. Smith*) (BMNH, type no. Rh. 8499; Gabriel, 1927: 9), here designated [examined].

*Phyciodes alexon* Godman & Salvin; Godman & Salvin, 1901: 681, pl. 108, figs 23-26.

? *Phyciodes natalces* Dyar, 1913a: 279. Holotype ♀, MEXICO: Rascon, San Luis Potosi (*R. Müller*) (USNM, Type no. 14487).

*Phyciodes nebulosa alexon* Godman & Salvin; Hall, 1929: 102.

♂ forewing 17-18 mm, upperside markings chiefly white or cream, with small, confused brown marbling at base; hindwing orange-brown markings more prominent. ♀ similar, slightly larger.

DISTRIBUTION. Mexico.

*Anthanassa alexon subconcolor* (Röber)

(Fig. 240)

*Phyciodes subconcolor* Röber, 1913: 441, pl. 90, row b [fig. 1] (♂). LECTOTYPE ♂, U.S.A.: Benson, Arizona (*O. T. Baron*) (BMNH), here designated [examined]. [Specimen bears Röber's original determination label, and a separate, pink 'type' label, ex Rothschild Coll.]

*Phyciodes nebulosa subconcolor* Röber; Hall, 1929: 102.

♂ forewing 19 mm, larger than *alexon alexon*, upperside yellow-brown markings more prominent and with general brown flush overall. ♀ larger, markings similar.

DISTRIBUTION. Arizona.

*Anthanassa acesas* (Hewitson) comb. n.

(Figs 24, 241)

*Eresia acesas* Hewitson, [1864]: [24], pl. [12], figs 48, 49. LECTOTYPE ♀, VENEZUELA (BMNH, Type no. Rh. 8466; Gabriel, 1927: 5), here designated [examined].

? *Phyciodes annita* Staudinger, 1885: 92, pl. 36. ♂ syntype(s), VENEZUELA: Merida (*Hahnel*) (? MNHU, Berlin).

*Phyciodes acesas acesas* (Hewitson); Hall, 1929: 107, pl. 1, fig. 2 (♂).

This and the following species (*A. nebulosa*) must be distinguished from species of *Telenassa* with rather similar ocellar ring markings on the upperside of the hindwings.

♂ forewing 15 mm, upperside very dark with a few indistinct or obsolescent yellowish markings in the submarginal area, otherwise unmarked; underside discal and postdiscal markings well developed as in *A. nebulosa*; hindwing upperside no basal markings, postdiscal series of yellowish lunules forming 5 rings in s1b-s5, rings completed by short striae proximal to submarginal lunules. ♀ slightly larger, upperside markings better defined.

*Genitalia*. ♂ like *A. ardys*, apical teeth of valve rather long, harpe slender, posterior border of juxta almost straight.

DISTRIBUTION. Venezuela.

*Anthanassa nebulosa* (Godman & Salvin) comb. n.

(Figs 25, 242, 243)

*Phyciodes nebulosa* Godman & Salvin, 1878a: 269. LECTOTYPE ♂, GUATEMALA: Las Nubes (*O. Salvin*) (BMNH, Type no. Rh. 8501; Gabriel, 1927: 85), here designated [examined].

*Phyciodes castianira* Godman & Salvin, 1880: 123, 131, pl. 4, fig. 10. LECTOTYPE ♂, COLOMBIA: Manaure, Sierra Nevada de Santa Marta (*F. Simons*) (BMNH, Type no. RH. 8504; Gabriel, 1927: 27), here designated [examined]. **Syn. n.**

*Phyciodes nebulosa* Godman & Salvin; Godman & Salvin, 1882: 205, pl. 22, figs 13, 14; Röber, 1913: 443, pl. 88, row i [fig. 7].

*Phyciodes nebulosa nebulosa* Godman & Salvin; Hall, 1929: 101.

♂ forewing 16-17 mm, small, upperside dark brown, markings orange-yellow, in general pattern like *A. drusilla*, postdiscal spots in s1b and s4 prominent, spot at middle of s1b present; hindwing upperside with basal striae, a narrow, inconspicuous discal band divided by dark veins, and postdiscal lunules forming a series of 5 ocelliform rings, each completed by short striae placed before the submarginal lunules. ♀ larger, 18 mm, all markings brighter, well defined, postdiscal spots joined to make a wide yellowish band.

*Genitalia*. ♂ like *A. acesas*.

DISTRIBUTION. N. Colombia, Guatemala.

DISCUSSION. The holotype of *A. nebulosa* is a rather dark specimen of the species later described by Godman & Salvin as *castianira*, and this name must fall as a synonym, but remains available if required.

The two forms are not truly identical. The lectotype of *nebulosa* is slightly darker on the upperside, with markings somewhat obscured by brown dusky suffusion, when compared with the original type-material of *castianira*, five males all from the Cinchicua Valley in N. Colombia.

*Anthanassa argentea* (Godman & Salvin) **comb. n., stat. rev.**

(Figs 26, 244)

*Phyciodes argentea* Godman & Salvin, 1882: 207. LECTOTYPE ♂, GUATEMALA: Choctum (*Hague*) (BMNH, Type no. Rh. 8468; Gabriel, 1927: 16), here designated [examined].

*Phyciodes atronia atronia* f. *argentea* Godman & Salvin; Hall, 1929: 111.

♂ forewing 16 mm, like *A. atronia*, upperside very dark, but with wide field of chestnut-brown over inner margin and discal area, pale postdiscal spots in s1b and s4 distinct, other markings more or less vestigial; hindwing upperside brown flush generally extends along inner margin; forewing underside costa and much of hindwing pale grey with fine dark striae. ♀ upperside less dark, markings yellow, spots arranged as in *A. drusilla*; hindwing underside yellow-grey with few markings.

*Genitalia.* ♂ like *A. ardys*, tegumen membranous and very fragile, valve apex slender in dorsal view, posterior margin of juxta straight. ♀ not examined.

DISTRIBUTION. Mexico, Guatemala, Nicaragua.

DISCUSSION. This taxon is treated by Hall as a 'form' of *A. atronia*, with the observation that both forms fly together at Orizaba in Mexico. In the short series present in the BMNH and in the Hall coll. (BM, Brighton) the distinctive markings are constant and specific rank seems to be more appropriate.

*Anthanassa atronia* (Bates) **comb. n.**

(Figs 27, 28, 245)

*Melitaea atronia* Bates, 1866: 113. LECTOTYPE ♂, GUATEMALA: Dueñas (BMNH, Type no. Rh. 8470; Gabriel, 1927: 18), here designated [examined].

? *Eeresia sydra* Reakirt, 1866b: 335. Syntype(s), MEXICO: near Vera Cruz (*W. H. Edwards*) (depository uncertain, possibly destroyed).

*Eeresia obscurata* Felder, 1869: 471. LECTOTYPE ♂, MEXICO: Cuernavaca (BMNH) here designated [examined].

? *Phyciodes diallus* Godman & Salvin, 1878b: 260. Syntype(s) ♀, PANAMA: Chiriqui (*Ribbe*) (MNHU).

? *Phyciodes chromis* Godman & Salvin, 1878b: 260. Syntype(s) ♀, PANAMA: Chiriqui (*Ribbe*) (MNHU).

*Phyciodes cassiopea* Godman & Salvin, 1878b: 262. LECTOTYPE ♀, COSTA RICA: Cache (*H. Rogers*) (BMNH, Type no. Rh. 8471; Gabriel, 1927: 27), here designated [examined].

*Phyciodes diallus* Godman & Salvin; Godman & Salvin, 1882: 207, pl. 22, figs 24, 25.

*Phyciodes cassiopea* Godman & Salvin; Godman & Salvin, 1882: 207, pl. 22, figs 22, 23; Röber, 1913: 441, pl. 90, row a [fig. 4] (♂).

*Phyciodes atronia* (Bates); Godman & Salvin, 1882: 206, pl. 22, figs 19–21, Forbes, 1945: 172–178.

? *Phyciodes albofascia* Röber, 1913: 441, pl. 90, row b [fig. 6] (♀, as *albifascia*). Syntype(s) ♀, GUATEMALA (depository unknown).

*Phyciodes atronia atronia* (Bates); Hall, 1929: 109.

*Phyciodes atronia diallus* Godman & Salvin; Hall, 1929: 111.

♂ forewing 17 mm, upperside very dark brown, markings paler brown, usually obscure, small white or yellowish postdiscal spots in s1b and s4 always present on both surfaces; hindwing upperside costal area dark brown, unmarked; forewing underside medium brown, discal and postdiscal markings very obscure or absent. ♀ forewing 19–21 mm, larger, markings variable, in a pattern like *A. drusilla*, yellowish (nominotypical form) or white (♀-forms *cassiopea*, *albofascia*). In ♀-form *diallus* markings white, costal bar and postdiscal spots united to form a prominent fascia, recorded by Hall as a constant form at Chiriqui.

*Genitalia.* ♂ like *A. ardys*, posterior margin of juxta straight in dorsal view, penis slender. ♀ not examined.

DISTRIBUTION. Mexico, Guatemala, Costa Rica, Nicaragua, Panama.

DISCUSSION. The ♀-form *chromis* is included here with reserve. It is not figured and the type-material has not been examined. Described from one or more specimens in the Staudinger Coll., perhaps similar to ♀-form *diallus*.



*Anthanassa otanes* (Hewitson) **comb. n.**

(Figs 29, 30, 246)

*Eresia otanes* Hewitson, [1864]: [24], pl. [12], fig. 47.

♂ forewing 18 mm, upperside dark brown with or without small yellow markings in the general pattern of *A. drusilla*; hindwing leaden blue, unmarked except for a narrow black marginal border; hindwing underside marbled brown and yellow, brown mark at apex of costa prominent. ♀ larger, upperside markings more complete.

*Genitalia.* ♂ tegumen and scaphial extension well defined, lateral walls partly chitinized, posterior border of juxta sinuous with central boss, posterior section of valve rather long, harpe stout, penis slender. ♀ not examined.

DISTRIBUTION. Mexico, Guatemala, Costa Rica.

Two subspecies with similar genitalia.

*Anthanassa otanes otanes* (Hewitson)

(Figs 29, 30)

*Eresia otanes* Hewitson, [1864]: [24], pl. [12], fig. 47. LECTOTYPE ♂, GUATEMALA (*O. Salvin*) (BMNH, Type no. Rh. 8473; Gabriel, 1927: 91), here designated [examined].

*Phyciodes otanes* (Hewitson) Godman & Salvin, 1882: 208, pl. 22, figs 28, 29.*Phyciodes otanes otanes* (Hewitson); Hall, 1929: 112.

♂ upperside very dark, markings vestigial if present. ♀ larger, upperside markings complete, white or shaded brown, in general pattern as *A. drusilla*.

DISTRIBUTION. Guatemala, only in western areas (Hall).

*Anthanassa otanes sopolis* (Godman & Salvin)

*Phyciodes sopolis* Godman & Salvin, 1878b: 262; Godman & Salvin, 1882: 209, pl. 22, figs 30–32. LECTOTYPE ♂, GUATEMALA: Vera Paz, Choctum (*Hague*) (BMNH, Type no. Rh. 8474; Gabriel, 1927: 112), here designated [examined].

*Phyciodes cyno* Godman & Salvin, 1889: 354; Godman & Salvin, 1901: 680, pl. 108, figs 27–30. Holotype ♂, MEXICO: Orizaba (*H. J. Elwes*) (BMNH, Type no. Rh. 8472; Gabriel, 1927: 37), [examined]. **Syn. n.**

*Phyciodes dora* Schaus, 1913: 345, pl. 51, fig. 9; Hall, 1929: 122; Forbes, 1945: 174. Syntype(s) ♀, COSTA RICA: Poas (? USNM). **Syn. n.**

*Phyciodes otanes sopolis* Godman & Salvin; Hall, 1929: 113.*Phyciodes otanes cyno* Godman & Salvin; Hall, 1929: 114.

♂ forewing like *otanes otanes*, but upperside yellow markings complete, discal macules sometimes enlarged (f. *cyno*). ♀ upperside markings well developed as in *A. drusilla*, forewing markings yellow (*sopolis*) or white (*cyno*), clearly quite variable. The form *dora* is probably a florid modification of *sopolis*.

*Genitalia.* ♂ like *otanes otanes*. ♀ not examined.

DISTRIBUTION. Guatemala (in eastern regions), Mexico, Costa Rica.

DISCUSSION. All forms of this species are rare and material available is scanty. It is probably that *otanes* and *sopolis* represent parts of a cline.*Anthanassa annulata* sp. n.

(Figs 31, 247, 248)

♂ forewing 15 mm, apex truncate, upperside dark brown, markings like *A. otanes*, small yellow spots, cell spot small, narrow oblique postdiscal mark in s4–s6, spot at base of s2 prominent, extending into s1b and s3, small round spots in s1b and s4 proximal to scanty vestigial submarginal markings, fringes chequered, brown and white; hindwing upperside dark brown, base unmarked, vestigial stria on discoidal veins, discal and postdiscal lunules joined to form circles in s1b–s3, narrow submarginal lunules in complete series from s1b–s7, fringes chequered. Underside forewing markings as above but paler buff

and orange-brown mark present on outer margin; hindwing grey with confused brown striae, conspicuous brown mark on costa and along outer margin to s4. ♀ similar, larger.

*Genitalia.* ♂ tegumen very fragile, membranes, bilobed, unfortunately distorted in preparation, posterior border of juxta concave, saccus small, posterior section of valve short, stout, harpes massive. There is marked similarity to the organs of *A. crithona*.

Holotype ♂, **Ecuador**: Paramba, 3500 ft [1160 m], iv. 1897 (*Rosenberg*) (genitalia slide no. 1351) (BMNH). Paratypes. **Colombia**: 2 ♂, Rio Dagan, (*Rosenberg*). **Ecuador**: 2 ♂, 1 ♀, Cachabé, low country, 1897 (*Rosenberg*). (All in BMNH.)

DISTRIBUTION. Ecuador and Colombia.

*Anthanassa crithona* (Salvin) **comb. n.**

(Figs 32, 249–251)

*Melitaea crithona* Salvin, 1871: 415. LECTOTYPE ♂, PANAMA: Chiriqui (*Arcé*) (BMNH, Type no. Rh. 8477; Gabriel, 1927: 36), here designated [examined].

*Phyciodes crithona* (Salvin) Godman & Salvin, 1882: 206, pl. 22, figs 17, 18; Röber, 1913: pl. 89, row k [figs 2–4]; Hall, 1929: 127.

♂ forewing 17 mm, upperside dark, prominent postdiscal band yellow; hindwing dark with yellow striae in discal, postdiscal and submarginal series. ♀ forewing 24 mm, upperside markings paler and extended.

*Genitalia.* ♂ in dorsal view short, wide, valve apex conical, harpe massive, posterior border of juxta slightly concave. ♀ ductus short, bursal support well defined.

DISTRIBUTION. Nicaragua, Costa Rica, Panama.

*Anthanassa fulviplaga* (Butler) **comb. n., stat. rev.**

(Figs 33, 252–254)

*Phyciodes fulviplaga* Butler, 1872: 77; Butler, 1874: 183, pl. 63, fig. 2; Godman & Salvin, 1882: 208, pl. 22, figs 26, 27; Röber, 1913: 441, pl. 90, row a [figs 2, 3]; Hall, 1929: 114. LECTOTYPE ♂, COSTA RICA: Cartago (*van Patten*) (BMNH, Type no. Rh. 8476; Gabriel, 1927: 53), here designated [examined].

*Phyciodes crithona stenotaenia* Röber, 1913: 440, pl. 89, row k [fig. 8]. Holotype ♀, COSTA RICA: Juan Vinas (BMNH) [examined].

*Phyciodes otaenes fulviplaga* Butler; Forbes, 1945: 175, 190.

♂ forewing 16 mm, upperside brown with large costal mark orange-yellow and small yellow spots in postdiscal area; hindwing leaden-grey with yellow submarginal lunules in series. ♀ forewing 21 mm, upperside markings more extensive.

*Genitalia.* ♂ tegumen membranes in dorsal view, posterior border or juxta with central prominence, apical section of valve short, harpe very massive; penis apex slender. ♀ ductus partly chitinized, bursal support not well defined.

DISTRIBUTION. Costa Rica, Panama.

*Anthanassa hermas* (Hewitson) **comb. n., stat. rev.**

(Figs 34, 255–257)

*Eresia hermas* Hewitson, [1864]: [21], pl. [11], fig. 32. LECTOTYPE ♂, BRAZIL: Recife, Pernambuco, (*Mrs G. Smith*) (BMNH), Type no. Rh. 8515; Gabriel, 1927: 59), here designated [examined].

*Eresia conferta* Felder & Felder, 1867: 394. LECTOTYPE ♀, BRAZIL: Bahia, *Luschnath* (BMNH), here designated [examined]. [Bears Felders' original M/S label *E. conferta* Feld.]

? *Phyciodes brancodia* Schaus, 1902: 394. Holotype ♂, BRAZIL: São Paulo (USNM, type no. 5887).

*Phyciodes aequatorialis* Röber, 1913: 442, pl. 90, row c [fig. 4] (? ♀). Syntype(s), ECUADOR (depository unknown).

? *Phyciodes aequatorialis gisela* Röber, 1913: 442. Syntype(s), BRAZIL: Mato Grosso (depository unknown).

*Phyciodes conferta* (Felder & Felder) Röber, 1913: 443, pl. 90, row d [fig. 8] (♂).

*Phyciodes hermas* (Hewitson) Hall, 1929: 98.

*Phyciodes (Eresia) frisia hermas* (Hewitson); Forbes, 1945: 156, 172, 189.

*Phyciodes frisia hermas* (Hewitson); Hayward, 1964b: 330, pl. 18, fig. 14 (♂).

♂ forewing 16 mm, upperside markings small white spots on dark brown ground-colour; ♀ similar, usually larger. In both sexes upperside of forewings 2 pairs of prominent white spots form a distinctive specific character (Hall).

*Genitalia.* ♂ in dorsal view tegumen wide, scaphial extension very short, lateral walls minutely toothed, posterior border of juxta convex, valve apical teeth blunt, saccus massive; penis slender. ♀ ductus partly chitinized, bursal support not well defined.

**DISTRIBUTION.** Brazil, Paraguay, N. Argentina, ? Ecuador.

### *Anthanassa frisia* (Poey) **comb. rev.**

(Figs 35, 258–260)

*Melitaea frisia* Poey, 1832: [9], pl. [2], figs (♂, ♀). Syntype(s) ♂, ♀, CUBA (depository unknown).

*Eresia gyges* Hewitson, [1864]: [24], pl. [12], figs 45, 46. LECTOTYPE ♂, JAMAICA (BMNH, Type no.

Rh. 8498; Gabriel, 1927: 56), here designated [examined].

*Eresia frisia* (Poey); Hewitson, [1866]: iv (corrections).

*Phyciodes frisia frisia* (Poey); Hall, 1929: 83.

*Phyciodes (Eresia) frisia frisia* (Poey); Forbes, 1945: 156; Bauer, 1975: 142, pl. 44, fig. 16.

*Phyciodes (eresia) frisia gyges* (Hewitson); Forbes, 1945: 157.

*Anthanassa frisia* (Poey); Holland, 1947: 140, pl. 17, fig. 42.

*Phyciodes frisia* (Poey); Riley, 1975: 79, pl. 6, fig. 12 (♂).

♂ forewing 15–16 mm, variable, upperside brown, markings orange-yellow, spot near anal in s1b prominent, usually with minute spot above it in s2; hindwing upperside prediscal band wide at costa, tapering gradually to vlc. ♀ similar, often larger.

*Genitalia.* ♀ tegumen large, scaphial extension short, lateral walls toothed, posterior border of juxta curved; penis in side view slender. ♀: short ductus partly chitinized, bursal support defined.

**DISTRIBUTION.** Cuba, Trinidad, Jamaica, Hispaniola, Puerto Rico, Bahamas, and probably on other islands, and U.S.A. (Texas, Florida: Key West).

### *Anthanassa tulcis* (Bates)

(Figs 36, 261–263)

*Melitaea tulcis* Bates, 1864a: 82. LECTOTYPE ♂, GUATEMALA: Central Valleys (BMNH, Type no. Rh. 8513; Gabriel, 1927: 120), here designated [examined].

? *Eresia archesilea* Felder, 1869: 471. Syntypes ♂, ♀ MEXICO: Cordoba (*Hedemann*) (? NM, Vienna).

*Eresia punctata* Edwards, 1871c: 191. Holotype ♂, [MEXICO]: 'S. Arizona' (*Palmer*) (CM, Pittsburgh). [See Brown, 1966: 424, fig. 23.]

*Phyciodes tulcis* (Bates); Röber, 1913: 441, pl. 90, row b [fig. 8] (♂).

*Phyciodes frisia tulcis* (Bates); Hall, 1929: 84.

*Phyciodes (Eresia) frisia tulcis* (Bates); Forbes, 1945: 156; Bauer, 1975: 142, pl. 44, fig. 19.

*Anthanassa tulcis* (Bates); Holland, 1947: 141, pl. 17, fig. 39.

♂ forewing 14 mm, small but variable, like *A. frisia*, upperside dark grey-brown, markings very pale, yellowish; hindwing upperside prediscal band very small or absent, postdiscal line absent, pale discal band relatively wide, prominent. ♀ similar, larger.

*Genitalia.* ♂ like *frisia*, in dorsal view scaphial extension wider, lateral teeth small, more numerous, posterior border of juxta more convex, slightly irregular with low central bulge. ♀ bursal duct short, partly chitinized, support oval.

**DISTRIBUTION.** From U.S.A. (Texas), Mexico and Guatemala through Central America to Panama.

*Anthanassa dubia* (Hall) comb. n., stat. n.

(Figs 37, 264)

[*Phyciodes frisia* (Poey); Godman & Salvin, 1882: pl. 22, fig. 6; Röber, 1913: pl. 89, row e [fig. 6] (♂).  
Misidentifications.]

*Phyciodes frisia dubia* Hall, 1929: 85. Holotype ♂, VENEZUELA: San Esteban, Puerto Cabello, ex *Hahnel* (BMNH; note: there may be a 'false type' of this taxon in BM, Brighton) [examined].

*Phyciodes (Eresia) frisia dubia* Hall; Forbes, 1945: 156.

♂ forewing 13–15 mm, like *A. tulcis* but upperside ground-colour brown, markings yellow, hindwing upperside prediscal band present but short, extending to v5, discal band relatively wide, postdiscal markings present. ♀ similar, larger.

*Genitalia*. Like *A. frisia*.

DISTRIBUTION. Venezuela and coastal districts of Colombia.

*Anthanassa taeniata* (Röber) comb. n., stat. rev.

(Figs 38, 265)

*Phyciodes taeniata* Röber, 1913: 438, pl. 89, row h [figs 3, 4] (♂, ♀). ♂, ♀ Syntypes ♂, ♀, PERU: Tarapoto (depository unknown).

*Phyciodes frisia taeniata* Röber, Hall, 1929: 85.

*Phyciodes (Eresia) frisia taeniata* Röber; Forbes, 1945: 156.

♂ forewing 16–17 mm, upperside brown, markings bright fulvous, like *frisia* but with additional spot in s2 near anal angle; hindwing upperside prediscal band well developed, extending to v2, discal band, postdiscal line and submarginal lunules all present in complete series. ♀ similar, slightly larger.

*Genitalia*. Like *A. frisia* but wider, lateral shoulders better marked, scaphial extension slightly narrower, dentate borders almost horizontal with larger teeth, saccus enlarged, posterior section of valve shorter, posterior border of juxta straight. ♀ not examined.

DISTRIBUTION. Ecuador, W. Peru. Distribution probably restricted to this area.

DISCUSSION. The four preceding species are clearly closely related and might be grouped as subspecies (following Hall). I find this treatment not really satisfactory since the different phenotypes are so well marked and easily distinguished, and intermediates have not been found in the extensive series in the BMNH. Each form appears to be vicarious and allopatric. The presence of two forms flying in the same district would confirm specific separation, but so far this has not been recorded.

*Anthanassa sosis* (Godman & Salvin) comb. n.

(Figs 39, 266)

*Phyciodes sosis* Godman & Salvin, 1878b: 262; Godman & Salvin, 1882: 204, pl. 22, figs 11, 12; Röber, 1913: 442, pl. 90, row d [fig. 1] (♂); Hall, 1929: 95; Forbes, 1945: 178. LECTOTYPE ♂, COSTA RICA: Irazu, 6000–7000 ft [2000–2300 m] (*H. Rogers*) (BMNH, Type no. Rh. 8482; Gabriel, 1927: 112), here designated [examined].

♂ forewing 16–17 mm, upperside black, markings small, yellow, spots arranged as in *A. otales sopolis*; hindwing upperside with 3 series of white or yellowish lunules parallel with the outer margin, hindwing underside marbled in shades of brown and grey. ♀ larger, markings extended.

*Genitalia*. ♂ tegumen short, firmly chitinized, scaphial extension well defined, saccus narrow but deep, valve in dorsal view shows 3 strong apical teeth, harpe slender, slightly sinuous. ♀ not examined.

DISTRIBUTION. Costa Rica, Panama, Colombia.

*Anthanassa drymaea* (Godman & Salvin) **comb. n.**

(Figs 40–267)

*Phyciodes drymaea* Godman & Salvin, 1878a: 268; Godman & Salvin, 1882: 205, pl. 22, figs 9, 10; Röber, 1913: 442, pl. 90, row c [fig. 7] (♂); Hall, 1929: 93; Forbes, 1945: 177–178. LECTOTYPE ♂, GUATEMALA: hacienda Las Nubes (*O. Salvin*) (BMNH, Type no. Rh. 8481; Gabriel, 1927: 42), here designated [examined].

♀ forewing 16–17 mm, like *A. ardys*, upperside dark brown (? black when fresh) with small white markings; forewing underside base grey-brown; hindwing upperside with curved discal series of 5 very small white spots; underside brown marbled with grey, with darker costal mark. ♀ slightly larger, hindwing underside markings paler.

*Genitalia.* ♂ organs narrow, elongate, tegumen chitinated, lateral walls gently concave, scaphial extension very short, saccus conspicuously narrow, cleft short, valve apex with 3 teeth, one very long directed medially, harpe short, slightly curved with a small, ventral tooth; penis slender.

**DISTRIBUTION.** Guatemala. Recorded at altitudes of 4000–7000 ft [1460–2560 m] at Calderas, Purula, Las Nubes, etc.

**NOTE.** Can be distinguished from *A. ardys* (p. 98) by the very small, widely separated white discal spots on hindwing upperside.

*Anthanassa sitalces* (Godman & Salvin) **comb. n.**

(Figs 41, 268)

*Phyciodes sitalces* Godman & Salvin, 1882: 201, pl. 21, figs 30, 31; Röber, 1913: 442, pl. 88, row i [fig. 5]; Hall, 1929: 95. LECTOTYPE ♂, GUATEMALA: Chilasco (*G. C. Champion*) (BMNH, Type no. Rh. 8489; Gabriel, 1927: 111), here designated [examined].

*Phyciodes sitalces saltator* Hall, 1929: 96. Holotype ♂, MEXICO: Guerrero, Omilteme, July, 8000 ft [2600 m] (*H. Smith*) (BMNH) [examined]. **Syn. n.**

♂ forewing 19–20 mm, like *A. drymaea* but larger; upperside dark brown (? black when fresh), markings small white spots; hindwing upperside postdiscal white spots very small, the series strongly curved, forewing underside base bright orange-brown. ♀ similar, slightly larger.

*Genitalia.* ♂ like *A. drymaea* but less elongate, saccus wider, apical horizontal tooth of valve shorter, curved downwards, harpe with 2 or 3 basal teeth below. ♀ not examined.

**DISTRIBUTION.** Guatemala, Mexico. Flies at 6000–8000 ft [2000–2600 m] in mountains.

*Anthanassa cortes* (Hall) **comb. n.**

(Figs 42, 269)

*Phyciodes cortes* Hall, 1917: 161. Lectotype ♂, MEXICO: Cuautla, 4000 ft [1300 m] June–July (*A. Hall*) (BM, Brighton), designated by Hall, 1929: 93 [examined].

♂ forewing 18–19 mm, upperside like *A. ardys* etc., but white spots are slightly larger and well defined; hindwing upperside white postdiscal spots in series all well separated, unlike *A. ardys* in which the white band is only divided by the intersection of black veins. ♀ upperside ground-colour paler, grey-brown, markings larger, underside forewing bases orange-brown.

*Genitalia.* ♂ like *A. sitalces*, in dorsal view the teeth below the base of harpe less prominent.

**DISTRIBUTION.** SW. Mexico. The type—series of 11 ♂, 1 ♀ were all taken by Hall near Cuautla. I have not seen or heard of other material.

**DISCUSSION.** The species *A. sosis*, *A. drymaea*, *A. sitalces* and *A. cortes* form an interesting and clearly related group, indicated by the presence of elaborate teeth at the apices of the valves. All appear to be rare, three of them being represented in the BMNH by short series, while *A. sitalces* is known only from the original series. The taxonomic position of *A. cortes* is uncertain; possibly it is better graded as a subspecies with *A. sitalces*, but the difference in external characters is most definite.

**DAGON gen. n.**

Type-species: *Eresia catula* Hopffer. Gender: masculine.

Small butterflies, forewing 13–15 mm, outer margin straight; hindwing outer margin slightly wavy; in all species upperside dark brown or black with small white or yellow markings; underside markings more variable, hindwing with small ocellar postdiscal spots in s1c–s6. Sexes similar.

*Genitalia.* ♂ organs narrow, elongate, tegumen well defined, posterior border of juxta convex, saccus prominent, elongate, broad, widest at its apex which is broadly notched, subapical tooth present before valve apex; penis slender, ostium-kneel absent (*D. catula* and *D. pusillus*).

DISTRIBUTION. NW. Argentina (Salta), S. Peru, Bolivia.

DISCUSSION. The four small butterflies included in this genus form an interesting group, the males being distinguished at once by their narrow, elongate genitalia which are similar in all species. The sharply pointed twin teeth at the apices of the valves, and the slender penes, suggest relationship with *Anthanassa*, but this is not confirmed by the shapes of the wings (the forewings with straight outer margins), the pattern of wing markings, and especially by the long, wide saccus, with no more than a shallow terminal notch. Only a single specimen is known of the little species *fontus*, and the genitalia have not been examined, but judging by the external characters it probably belongs to this genus.

Forbes (1945) keys out three of the species as his group 13; the fourth species (*morenus*) he includes in his key to combined groups 11 and 15.

NOTE. The mythological Dagon was like a mermaid—‘upwards man and downwards fish’. The name is proposed with allusion to the extraordinary development of the saccus, shaped like the tail of a fish, in this small and obscure genus.

**Key to species of *Dagon* (based on Forbes, 1945)**

- |   |  |                          |
|---|--|--------------------------|
| 1 | Upperside forewing dark brown, almost unmarked except for traces of submarginal lunules                            | <i>morenus</i> (p. 109)  |
| – | Dark upperside forewing with small yellowish white discal spots . . . . .  | 2                        |
| 2 | Spot in hindwing cell s1b isolated, in line with postmedian band, the spot in s2 offset outward                    | <i>catula</i> (p. 109)   |
| – | Hindwing pattern not as above . . . . .  | 3                        |
| 3 | Postmedian spots in hindwing cells s2 and s1b in line, that in cell s3 offset outward                              | <i>pusillus</i> (p. 108) |
| – | Postmedian spots in cells s1b–s3 all in line, that in s4 offset outward; underside much paler, yellowish . . . . . | <i>fontus</i> (p. 109)   |

***Dagon pusillus* (Salvin) comb. n.**

(Figs 43, 270, 271)

*Eresia pusilla* Salvin, 1869: 172. LECTOTYPE ♂, PERU: Cosnipata Valley (*H. Whitely*) (BMNH, Type no. Rh 8533; Gabriel, 1927: 101), here designated [examined].

*Eresia calena* Hopffer, 1874: 350. Syntypes ♂, PERU: Chanchamayo (*Thamm*) (? MNHU, Berlin).

*Eresia adoxa* Erschoff, 1874: 142, pl. 3, fig. 5. Syntypes ♂, PERU: near Monterico (? ZI, Leningrad).

*Phyciodes calena* (Hopffer) Röber, 1913: 445, pl. 90, row g [fig. 2] (♂).

*Phyciodes pusilla* (Salvin) Hall, 1929: 118.

*Phyciodes (Tritanassa) pusilla* (Salvin); Forbes, 1945: 186, 190.

♂ forewing rather elongate, hindwing upperside discal white stripe narrow, postdiscal and submarginal markings vestigial, if present.

*Genitalia.* ♂ in dorsal view with tegumen short, fragile, posterior margin of juxta strongly convex, saccus elongate, valve apex short, stout, harpe relatively massive; penis slender. ♀ not available.

DISTRIBUTION. Peru, Bolivia.

*Dagon catula* (Hopffer) comb. n.

(Figs 44, 272, 273)

*Eresia catula* Hopffer, 1874: 350. Holotype ♂, 'BOLIVIA' (*Warscewicz*) (? MNHU, Berlin) [not examined; see note below].

*Phyciodes catula* (Hopffer) Röber, 1913: 445, pl. 90, row g [fig. 4].

*Phyciodes minima* Röber, 1913: 445, pl. 90, row g [fig. 3]. Syntype(s), ARGENTINA: Salta (depository unknown). Syn. n.

*Phyciodes catula extincta* Röber, 1913: 445, pl. 90, row g [fig. 5]. Syntype(s), PERU (? MNHU, Berlin). Syn. n.

*Phyciodes abasina* Staudinger (*in litt.*); Röber, 1913: 445 (invalid: proposed in synonymy with *catula*).

*Phyciodes birivula* Dyar, 1913b: 632. Holotype ♂, PERU: San Miguel, 6000 ft [2000 m] (USNM, Washington). Syn. n.

*Phyciodes catula catula* ab. *fulvocincta* Hall, 1929: 117. Holotype ♀, PERU/BOLIVIA boundary (BMNH) [examined].

*Phyciodes catula catula* (Hopffer); Hall, 1929: 117; Forbes, 1945: 187.

*Phyciodes catula birivula* Dyar; Hall, 1929: 118; Forbes, 1945: 186.

*Phyciodes catula minima* Röber; Hall, 1929: 118; Forbes, 1945: 186.

*Phyciodes catagraphus* Hayward, 1933: 214, 2 figs. Holotype ♀, ARGENTINA: Rosario de la Frontera (*A. Breyer*) (? IML, Tucumán). [Placed by Hayward, 1949: 12, as synonym of *P. teletusa signata*.] Syn. n.

♂ forewing 15 mm, like *D. pusillus* but broader (less elongate), upperside black, markings small, white or yellow; hindwing upperside postdiscal and submarginal markings present. ♀ larger, similar to ♂ but ground-colour variable, white to orange-brown (rare).

*Genitalia.* ♂ in dorsal view like *D. pusillus* but valve apex more slender, lower (apical) tooth long, sharply curved inwards, harpe slender, undulant, tegumen defined but fragile, short, posterior margin of juxta strongly convex, saccus long, wide; penis slender. ♀ not examined.

DISTRIBUTION. Peru, Bolivia, W. Argentina.

NOTE. According to Prof. K. S. Brown (*in litt.*) the *Warscewicz* material probably came from W. Colombia, not Bolivia; clearly it is important to examine the holotype of *catula* at the first opportunity.

*Dagon morenus* (Röber) comb. n.

(Figs 45, 274)

*Phyciodes morena* Röber, 1913: 443, pl. 90, row d [fig. 7]; Hall, 1929: 126, pl. 2, fig. 3; Forbes, 1945: 180. syntype(s) ♂, PERU: Cuzco (MNHU, Berlin).

♂ forewing 15 mm, upperside dark brown, almost unmarked, both wings with traces of submarginal lunules, hindwing with obscure, yellowish postdiscal ocelli. ♀ unknown.

*Genitalia.* ♂ organs like *D. catula*, apparently without individual specific characters.

DISTRIBUTION. Peru, Cuzco Province.

NOTE. There are 2 ♂ in the BMNH and 3 ♂ in coll. Hall (BM, Brighton), one of which has been dissected to make the preparation shown in the genitalia figure.

*Dagon fontus* (Hall) comb. n.

(Fig. 46)

*Phyciodes fontus* Hall, 1928a: 11; Hall, 1929: 75, pl. 2, fig. 2. Holotype ♂, GUYANA (BMNH) [examined].

*Phyciodes (Tritanassa) fontus* Hall; Forbes, 1945: 186, 190.

♂ forewing 14 mm, narrow, upperside black, markings yellowish white, several small discal spots as in *D. pusillus*, with suggestion also of a pale costal bar and an isolated small postdiscal spot in s5; hindwing upperside black, pale discal band narrow; underside general colour scheme pale brown, markings yellowish.

*Genitalia.* Not examined, abdomen missing.

DISTRIBUTION. The single known specimen is labelled 'British Guyana'.

*TELENASSA* gen. n.

Type-species: *Argynnis teletusa* Godart. Gender: feminine.

Rather small butterflies, outer margin of forewing excavate or entire, upperside usually with well-developed subapical bar; hindwing upperside usually with 3 rows of lunules parallel to outer margin, underside markings variable. Sexes similar or nearly so. Specific characters well marked.

*Genitalia.* ♂ in dorsal view with tegumen short, fragile; posterior border of juxta often with central prominence, valve long, narrow, apex curved inwards to terminate in a single point; saccus deeply cleft; penis straight, robust, distal section short, about one-third total length or little more, morula prominent but ostium-keel not developed. ♀ genitalia with ductus very short, bursal support cup-shaped.

**DISTRIBUTION.** The species occur over an extensive area in tropical South America, northwards to Colombia, but apparently absent from Central America.

**NOTE.** Of the species of *Telenassa* represented in the BMNH, eight lack females, although in some cases the males appear to be common.

**Key to species of *Telenassa***

*Note.* It has not been practicable to include *T. burchelli* (p. 111) in this key.

- |    |   |                             |
|----|---|-----------------------------|
| 1  | Forewing upperside with orange markings . . . . .   | 2                           |
| -  | Forewing upperside without orange markings . . . . .  | 5                           |
| 2  | Forewing orange subapical band wide, entire . . . . .   | 3                           |
| -  | Forewing not so marked . . . . .  | 4                           |
| 3  | Hindwing orange submarginal lunules vestigial . . . . .   | <i>jana</i> (p. 112)        |
| -  | Hindwing orange submarginal lunules developed . . . . .   | <i>elaphina</i> (p. 113)    |
| 4  | Forewing subapical band broken . . . . .  | <i>trimaculata</i> (p. 114) |
| -  | Forewing discal band broken . . . . .   | <i>delphia</i> (p. 115)     |
| 5  | Hindwing with orange discal band . . . . .  | 6                           |
| -  | Hindwing without discal band . . . . .  | 8                           |
| 6  | Forewing with cell-spot well developed . . . . .  | <i>signata</i> (p. 112)     |
| -  | Forewing with cell-spot vestigial or absent . . . . .   | 7                           |
| 7  | Forewing upperside postdiscal spot in s1, s2, s3 small, not extending to inner margin . . . . . | <i>berenice</i> (p. 111)    |
| -  | Forewing upperside postdiscal spot in s1, s2, s3 large, extending to inner margin . . . . .     | 9                           |
| 8  | Forewing upperside with proximal border of postdiscal spot vertical to inner margin . . . . .   | <i>teletusa</i> (p. 111)    |
| -  | Forewing upperside markings white . . . . .   | 10                          |
| -  | Forewing upperside lacking white markings . . . . .   | 12                          |
| 10 | Forewing with white subapical band . . . . .  | <i>nana</i> (p. 113)        |
| -  | Forewing not so marked . . . . .  | 11                          |
| 11 | Forewing with white submarginal spot in s3, but lacking subapical band; hindwing dark . . . . . | <i>nussia</i> (p. 113)      |
| -  | Forewing not so marked, hindwing with white discal band . . . . .                               | <i>abas</i> (p. 112)        |
| 12 | Forewing apex truncate . . . . .  | <i>sepulta</i> (p. 115)     |
| -  | Forewing apex not truncate . . . . .  | 13                          |
| 13 | Forewing underside crossed by 4 or 5 dark lines . . . . .                                       | <i>catenaria</i> (p. 114)   |
| -  | Forewing not so marked . . . . .  | 14                          |
| 14 | Hindwing upperside with wide yellowish discal band . . . . .                                    | <i>flavocincta</i> (p. 114) |
| -  | Hindwing not so marked . . . . .  | 15                          |
| 15 | Forewing underside with 2 dark postdiscal bands . . . . .                                       | <i>gaujoni</i> (p. 114)     |
| -  | Forewing underside postdiscal area dark, bands not defined . . . . .                            | <i>notus</i> (p. 113)       |



*Telenassa teletusa* (Godart) **comb. n.**

(Figs 47, 275–277)

*Argynnis teletusa* Godart, [1824]: 817. Syntype(s), BRAZIL (depository unknown).*Phyciodes teletusa teletusa* (Godart); Hall, 1929: 76.*Phyciodes (Tritanassa) teletusa* (Godart); Forbes, 1945: 183–184, 190.? *Phyciodes teletusa douglasi* Bryk, 1953: 87. Holotype ♂, PERU: Roque (NR, Stockholm).*Phyciodes teletusa* (Godart); Hayward, 1964b: 350, pl. 18, fig. 15.

Upperside dark brown (? black when fresh), markings deep yellow; ♂ forewing 16–18 mm, an erect postdiscal mark in s1, s2, s3, extends from middle of inner margin to v3, the proximal border vertical to inner margin; transverse band of hindwing 3–4 mm wide, often tapering slightly and shading to white at inner margin. ♀ similar, often larger and markings slightly paler, forewing usually with obscure pale mark at cell-end.

*Genitalia.* ♂ in dorsal view: posterior border of juxta straight with a small central prominence, all generic characters well developed. ♀ chitinized bursal duct short, bursal support well defined.

**DISTRIBUTION.** Central and S. Brazil, Peru.

*Telenassa burchelli* (Moulton) **comb. n., stat. rev.**

(Figs 49, 278, 279)

*Phyciodes burchelli* Moulton, 1909: 100. Holotype ♂, BRAZIL: Meiaponte to S. Joaquim (*Joaq. Alves/W. J. Burchell*) (UM, Oxford, Type no. 1108) [examined].[*Phyciodes teletusa* (Godart); Röber, 1913: pl. 89, row h [fig. 5] (♂). Misidentification.]*Phyciodes teletusa peruana* Röber, 1913: 438, pl. 89, row h [fig. 7]. Syntype(s) ♂, PERU (depository unknown).*Phyciodes teletusa burchelli* Moulton; Hall, 1929: 78; Forbes, 1945: 182–183.

♂ forewing 15–16 mm, narrow, outer margin straight, upperside markings yellow, like *T. teletusa*, usually smaller, postdiscal mark in s1, s2 and s3, proximal border oblique, obscure spot at cell-end often present; hindwing upperside transverse band wide, usually extending to postdiscal area. ♀ similar, larger.

*Genitalia.* Like *T. teletusa*.

**DISTRIBUTION.** Brazil, in Dept. Goiás and westwards through Mato Grosso to Peru. Recorded from Bolivia and Ecuador.

**DISCUSSION.** Hall records this species flying at low altitudes in the Amazon valleys, while *T. berenice* was present at high altitudes, not below 1,100 m (but see also Forbes, 1945: 183). *T. burchelli* shows little variation in the series of 49 ♂, 2 ♀ in the BMNH in spite of its wide distribution.

*Telenassa berenice* (Felder & Felder) **comb. n., stat. rev.**

(Figs 48, 280, 281)

*Eresia berenice* Felder & Felder, 1862a: 110. LECTOTYPE (♀?), PERU: 'Rio Negro' (BMNH), here designated [examined]. [Specimen bears Felders' M/S determination label.]*Phyciodes berenice* (Felder & Felder) Röber, 1913: 438, pl. 89, row i [fig. 1] (♂).? *Phyciodes drusinilla* Röber, 1913: 441, pl. 90, row a [fig. 8]; Hayward, 1964b: 337. Syntype(s) ♂, ARGENTINA (depository unknown).*Phyciodes teletusa berenice* (Felder & Felder); Hall, 1929: 78; Forbes, 1945: 182–184.

♂ forewing 16 mm, upperside dark brown, basal area unmarked, postdiscal area markings yellow like *T. teletusa* but small, costal bar short, postdiscal mark in s2 not large, usually extends into s1b and s3, but not reaching inner margin, small submarginal marks in s3 and in s4 present; hindwing upperside transverse band narrow, 2 mm or less, thin postdiscal line and submarginal lunules present. ♀ similar.

*Genitalia.* Like *T. teletusa*, perhaps a little wider; tegumen and scaphial extension differ, the latter less well defined, bilobed. ♀ not examined.

**DISTRIBUTION.** Peru (Dept. Amazonas), Ecuador, Bolivia?, Argentina?.

*Telenassa signata* (Hall) comb. n., stat. n.

(Figs 50, 282)

*Phyciodes teletusa signata* Hall, 1928a: 11; Hall, 1929: 77; Forbes, 1945: 182; Hayward, 1949: 12; 1964b: 352, pl. 18, fig. 16 (♂). Holotype ♂, ARGENTINA: Salta, Sierra de Aconquija, 3300 ft [1200 m] (BM, Brighton) [examined].

♂ forewing 15–16 mm, like *T. teletusa* but upperside markings slightly reduced, paler yellow; forewing with oblique prominent yellow mark at cell-end; hindwing yellow discal band narrow, not tapered at inner margin; hindwing underside pale yellow-buff, markings faint, lacking dark clouding along outer margin in s2–s5. ♀ not seen.

*Genitalia.* ♂ like *T. teletusa* but wider in dorsal view, tegumen shorter, posterior section of valve slender.

DISTRIBUTION. Argentina (Jujuy, Salta, Catamarca), Bolivia (Cochabamba).

NOTE. For distinction from *Ortilia sejona*, see p. 118.

*Telenassa abas* (Hewitson) comb. n.

(Figs 51, 283, 284)

*Eresia abas* Hewitson, [1864]: [22], pl. [11], figs 37, 38. LECTOTYPE ♂, COLOMBIA: New Grenada, Bogota (BMNH, Type no. Rh. 8512; Gabriel, 1927: 5), here designated [examined].

*Phyciodes abas* (Hewitson) Röber, 1913: 443, pl. 90, row e [figs 6, 7]; Hall, 1929: 115.

*Phyciodes (Eresia) abas* (Hewitson); Forbes, 1945: 160–161, 189.

♂ forewing 18 mm, outer margin very slightly excavate, upperside markings white, cell-spot often slightly elongate, placed a little before the disco-cellular vein; hindwing upperside discal band 2–3 mm wide, extending to s1c but not reaching inner margin, postdiscal yellowish line and white submarginal lunules usually vestigial. ♀ similar, markings often better developed.

*Genitalia.* ♂ in dorsal view like *T. teletusa*, tegumen and scaphial extension fragile, posterior border of juxta gently convex, terminal section of valve short, harpe rather slender. ♀ not examined.

DISTRIBUTION. Colombia, not seen from elsewhere.

NOTE. This species is often confused (e.g. Röber, 1913; Hall, 1929) with *Janatella fellula*. The latter can be identified by the white discal band on the upperside of the hindwing, which is continued to reach the inner margin. Specimens of *T. abas* with the white markings slightly reduced may be mistaken for *A. ardys subota*.

*Telenassa jana* (Felder & Felder) comb. n.

(Figs 52, 285, 286)

*Eresia jana* Felder & Felder, 1867: 394. LECTOTYPE ♂, COLOMBIA: Bogotá (*Lindig* (BMNH) here designated [examined]. [Specimen bears original M/S Felder determination label.]

*Eresia elaphiaea* Hewitson, [1868]: [33], pl. [19], figs 50, 51. LECTOTYPE ♂, ECUADOR (BMNH, Type no. Rh. 8464; Gabriel, 1927: 43), here designated [examined]. *Syn. n.*

*Phyciodes jana* (Felder & Felder) Röber, 1913: 439.

*Phyciodes elaphiaea* (Hewitson) Röber, 1913: 439, pl. 89, row i [fig. 7] (♂).

*Phyciodes jana jana* (Felder & Felder); Hall, 1929: 129; Forbes, 1945: 190.

*Phyciodes jana elaphiaea* (Hewitson); Hall, 1929: 129; Forbes, 1945: 190.

♂ forewing 17–19 mm, upperside dark brown with wide orange subapical band, hindwing dark, triple series of submarginal lunules rather faintly marked. ♀ similar, forewing 20 mm, markings paler.

*Genitalia.* Like *T. teletusa* in both sexes.

DISTRIBUTION. Colombia, Peru, Bolivia, Ecuador.

DISCUSSION. It is difficult to maintain a subspecific distinction between nominate *T. jana* from Colombia and specimens from Bolivia and Peru, referred by Hall to *elaphiaea*.

*Telenassa elaphina* (Röber) comb. n.

(Figs 53, 287)

*Phyciodes elaphiaea elaphina* Röber, 1913: 439, pl. 89, row i [fig. 9]. Syntype(s) ♂, BOLIVIA (depository unknown).

*Phyciodes elaphina* Röber; Hall, 1929: 130; Forbes, 1945: 180, 190.

♂ forewing 19–20 mm, outer margin deeply excavate, like *T. jana*, but upperside subapical band paler yellow, slightly irregular; hindwing upperside marginal lunules yellowish, usually well developed. ♀ unknown.

*Genitalia*. ♂ in dorsal view like *T. jana* Felder.

DISTRIBUTION. Bolivia.

*Telenassa nana* (Druce) comb. n.

(Figs 54, 288, 289)

*Phyciodes nana* Druce, 1874a: 156. LECTOTYPE ♂, PERU: Cosnipata Valley (*Whitely*) (BMNH, Type no. Rh. 8480; Gabriel, 1927: 84), here designated [examined].

? *Eresia geminia* Hopffer, 1874: 351. Syntypes ♂, PERU: Chanchamayo (*Thamm*), BOLIVIA: Moxos (*Pavon*) (? MNHU, Berlin).

? *Phyciodes omosis* Dyar, 1913b: 632. Syntypes, PERU: Pampaconas River (USNM, Washington).

*Phyciodes nana* Druce; Röber, 1913: 439, pl. 89, row i [fig. 6].

*Phyciodes geminia* (Hopffer); Röber, 1913: 439, pl. 89, row i [figs 4, 5].

*Phyciodes nana nana* Druce; Hall, 1929: 131; Forbes, 1945: 180.

*Phyciodes nana omosis* Dyar; Hall, 1929: 131; Forbes, 1945: 180.

♂ forewing 17–18 mm, upperside dark brown, subapical band white or yellowish (*omosis*), variable; hindwing upperside with triple series of lunules, postdiscal and submarginal lunules rather obscure, greyish. ♀ not seen.

*Genitalia*. ♂ like *T. teletusa* but larger, more robust; penis massive.

DISTRIBUTION. Peru, Bolivia.

*Telenassa nussia* (Druce) comb. n.

(Figs 55, 290)

*Phyciodes nussia* Druce, 1876: 222; Röber, 1913: 439; Hall, 1929: 132; Forbes, 1945: 180. LECTOTYPE ♂, PERU (BMNH, Type no. Rh. 8478; Gabriel, 1927: 88), here designated [examined].

♂ forewing 17 mm, like *T. nana* but on upperside the white subapical band is replaced by a single white submarginal spot in s3. Perhaps better graded as a local form of *T. nana*.

*Genitalia*. ♂ like *T. nana*. ♀ not available.

DISTRIBUTION. Peru: Chachapoyas (BMNH series 11, 1 ♂, all from the same locality). Hall has recorded a specimen (very doubtfully) from Paraguay.

*Telenassa notus* (Hall) comb. n.

(Figs 56, 291–293)

*Phyciodes notus* Hall, 1917: 163. Holotype ♂, PERU: Pozuzo (BM, Brighton) [examined].

*Phyciodes notus notus* Hall, 1929: 123, pl. 2, fig. 1 (♂).

*Phyciodes notus* f. *pullopecta* Hall, 1929: 124. Holotype ♂, PERU: Cushi, Huanuco Province (BMNH) [examined].

*Phyciodes (Tritanassa) notus* Hall; Forbes, 1945: 179, 190.

♂ forewing 16–17 mm, upperside dark brown, 2 small postdiscal spots in s4 and s6. ♀ forewing with 2 white subapical spots and fulvous submarginal spot in s3; hindwing with 4 fulvous discal spots.

*Genitalia*. ♂ in dorsal view like *Telenassa teletusa*, tegumen fragile.

DISTRIBUTION. Peru, Bolivia.

*Telenassa gaujoni* (Dognin) **comb. n.**

(Figs 57, 294)

*Phyciodes gaujoni* Dognin, 1887: 175, fig.; Hall, 1929: 125; Forbes, 1945: 179, 183, 190. Lectotype ♂, ECUADOR: Zamora (BMNH), designated by Hall, 1929: 125 [examined].

♂ forewing 14–17 mm, outer margin slightly excavate, upperside dark grey, submarginal lunules yellowish, preceded by a double series of slender lunules which tend to fuse, forming ocellar spots; underside marbled brown on pale grey, on forewing postdiscal area dark with confused marbling, on hindwing dark submarginal spots in s2–3–4 prominent. ♀ unknown.

*Genitalia.* ♂ in dorsal view like *T. teletusa*.

DISTRIBUTION. Ecuador, Colombia.

*Telenassa trimaculata* (Hewitson) **comb. n.**

(Figs 58, 295)

*Eresia trimaculata* Hewitson, 1869a: 28 [index]. LECTOTYPE ♂, ECUADOR: Rio Verde (*Buckley*) (BMNH, Type no. Rh. 8458; Gabriel, 1927: 120), here designated [examined].

*Phyciodes taphius* Godman & Salvin, 1878b: 263. LECTOTYPE ♂, ECUADOR: Canelos (*Buckley*) (BMNH, Type no. Rh. 8459; Gabriel, 1927: 116), here designated [examined].

*Phyciodes elaphiaea abrupta* Röber, 1913: 439, pl. 89, row i [fig. 8]. Syntype(s) ♂, ECUADOR/BOLIVIA: 'Andes' (depository unknown).

*Phyciodes trimaculata* (Hewitson) Hall, 1929: 127; Forbes, 1945: 180, 183, 190.

♂ forewing 15–17 mm, outer margin slightly excavate; upperside dark brown, markings yellow, an oblique subapical band present, formed of small spots; hindwing with ocellate postdiscal markings and lunulate submarginal line. ♀ not available.

*Genitalia.* ♂ like *T. teletusa*.

DISTRIBUTION. Ecuador, Bolivia.

*Telenassa flavocincta* (Dognin) **comb. n.**

(Figs 59, 296, 297)

*Phyciodes flavocincta* Dognin, 1887: 174, fig.; Hall, 1929: 119; Forbes, 1945: 179, 183, 190. Lectotype ♀, ECUADOR: Zamora (BMNH), designated by Hall, 1929: 120 [examined].

♂ forewing 16–17 mm, outer margin entire, both wings upperside brown, with postdiscal areas and submarginal lunules orange-yellow. ♀ not seen.

*Genitalia.* ♂ in dorsal view rather massive, like *T. nana*, tegumen short, bilobed scaphial extension short and very fragile.

DISTRIBUTION. Ecuador, N. Peru (Rio Tabacones, 2000 m).

*Telenassa catenaria* (Godman & Salvin) **comb. n.**

(Figs 60, 298)

*Phyciodes catenarius* Godman & Salvin, 1880: 123, 131, pl. 4, fig. 11; Hall, 1929: 124; Forbes, 1945: 179, 190. Holotype ♂, COLOMBIA: Sierra Nevada de Santa Marta, Chinchicua Valley (*Simons*) (BMNH, Type no. Rh. 8465; Gabriel, 1927: 27), [examined].

♂ forewing 17 mm, upperside dark grey-brown, markings yellow-grey, delicate, 2 rings in s1b near anal angle, continued with vestigial lunules to costa, discal markings vestigial if present, series of submarginal lunules complete; hindwing upperside postdiscal and premarginal lunules combine to form a complete series of postdiscal rings, submarginal lunules well defined. Underside pale buff, forewing crossed by brown lines, with small, blind ocelli in s5 and in s6. ♀ similar, slightly larger, forewing upperside with red-brown postdiscal shade.

*Genitalia.* ♂ like *T. teletusa*. ♀ not examined.

**DISTRIBUTION.** Colombia: Sierra Nevada de Santa Marta; recently also found in the Cordillera Occidental (*G. Bernard & M. Adams*).

*Telenassa delphia* (Felder & Felder) **comb. n.**

(Figs 61, 299)

*Eresia delphia* Felder & Felder, 1861: 103. **LECTOTYPE** ♀, COLOMBIA: near Muzo, Bogotá Province (*Uricoechea*) (BMNH), here designated [examined]. [Specimen bears original label of Felders'.]

*Eresia aceta* Hewitson, [1864]: [23], pl. [12], figs 39, 40. **LECTOTYPE** ♂, COLOMBIA: 'New Grenada' (BMNH, Type no. Rh. 8467; Gabriel, 1927: 6), here designated [examined].

*Phyciodes delphia delphia* (Felder & Felder); Röber, 1913: 440, pl. 89, row k [fig. 1].

*Phyciodes delphia aceta* (Hewitson); Röber, 1913: 440.

*Phyciodes delphia* (Felder & Felder); Hall, 1929: 120; Forbes, 1945: 183, 190.

♂ forewing 15–17 mm, outer margin slightly excavate, upperside dark brown, irregular broken discal band fulvous, and dark-pupilled postdiscal ocelli of similar colour in series across both wings, followed by submarginal lunules. ♀ slightly larger with markings better developed.

*Genitalia.* ♂ like *T. teletusa*. ♀ not examined.

**DISTRIBUTION.** Colombia: Muzo, El Baldio (5000 ft [1600 m]), Ecuador?

**NOTE.** In the BMNH there is a single specimen with upperside dark grey-brown and prominent unpupilled ocellar postdiscal spots, otherwise unmarked. It is clearly closely related to *T. delphia*, and possibly represents an unnamed species. Since only a single specimen is known, I have not named it at present.

*Telenassa sepulta* (Hall) **comb. n.**

(Figs 62, 300, 301)

*Phyciodes sepultus* Hall, 1928a: 12; Hall, 1929: 125, pl. 2, fig. 12; Forbes, 1945: 179, 190. **Holotype** ♂, PERU: Chachapoyas (*de Mathan*) (BMNH) [examined].

♂ forewing 19 mm, outer margin excavate, apex truncate and apical angle acute; upperside pale postdiscal and submarginal lunules obscure; underside yellow-brown, markings better defined, forewing with 4 pale postdiscal spots. ♀ not known.

*Genitalia.* Like *T. teletusa*, ♂ base wide, tegumen and scaphial extension well defined, penis with usual generic characters.

**DISTRIBUTION.** Peru.

**ORTILIA gen. n.**

Type-species: *Papilio liriopae* Cramer. Gender: feminine.

Rather small butterflies, uppersides usually dark brown or black with yellow or white markings. Specific characters are often poorly defined in the male genitalia. On the forewing upperside a large white or yellow postdiscal spot is present in s1b, s2, and s3, in several species. Markings and genitalia are somewhat atypical in the divergent species *ithra*.

*Genitalia.* ♂ tegumen usually short, fragile, sometimes vestigial, terminal section of valve curved inwards and a large pre-apical tooth is present in all species, forming a bifid or 'double' apex, harpe variable, exceptionally long in *liriopae* and in *gentina*, saccus always single (entire), penis slender, ostium-keel absent. ♀ examined in all species, bursal support shaped like an egg-cup, and often arising directly from a deeply excavated pocket in the genital plate, post-vaginal scutum large.

**DISTRIBUTION.** French Guiana, Guyana, Surinam, Brazil, Argentina, Bolivia, W. Peru (*O. gentina* only).

**DISCUSSION.** The genus is especially characteristic of the eastern regions of South America. In genitalia preparations the twin apical teeth at the valve apices may prove difficult to display.

Key to species of *Ortilia*

2	Upperside markings fulvous . . . . .	2
-	Upperside markings chiefly white . . . . .	9
2	Fulvous areas very extensive . . . . .	3
-	Fulvous areas macular, not extensive . . . . .	4
3	In dorsal view valve apex almost straight . . . . .	<i>liriope</i> (p. 116)
-	In dorsal view valve apex strongly curved . . . . .	<i>gentina</i> (p. 116)
4	Hindwing upperside discal band tapered to inner margin . . . . .	5
-	Hindwing discal band wide, not tapered . . . . .	6
5	Small, forewing 16 mm, hindwing discal band not well defined . . . . .	<i>polinella</i> (p. 119)
-	Large, forewing 19 mm, hindwing discal band well defined . . . . .	<i>zamora</i> (p. 119)
6	Forewing elongate . . . . .	<i>dicoma</i> (p. 119)
-	Forewing not elongate . . . . .	7
7	Upperside suffused fuscous, markings obscure . . . . .	<i>velica durnfordi</i> (p. 118)
-	Upperside markings well defined . . . . .	8
8	Upperside markings yellow, cell-spot prominent, well formed . . . . .	<i>sejona</i> (p. 118)
-	Upperside markings orange-brown, cell-spot, if present, not prominent, small . . . . .	<i>velica velica</i> (p. 118)
9	Upperside hindwing submarginal spot in s6-7 fulvous . . . . .	<i>orthia</i> (p. 117)
-	Upperside hindwing with this spot white . . . . .	10
10	Upperside forewing postdiscal spot in s4 prominent . . . . .	<i>ithra</i> (p. 120)
-	Upperside forewing postdiscal spot in s4 lacking . . . . .	<i>orticas</i> (p. 117)

*Ortilia liriope* (Cramer) comb. n.

(Figs 63, 302-304)

*Papilio liriope* Cramer, 1775: 2, pl. 1, figs C, D. Syntype(s), SURINAM (depository unknown).? *Argynnis liriope* (Cramer); Fabricius, 1807: 285.? *Dryas reticulata liriope* (Cramer); Hübner, 1808: pl. 40.*Phyciodes liriope* (Cramer); Röber, 1913: 435, pl. 89, row a [figs 1, 2]; ? Hayward, 1964b: 359, pl. 18, fig. 10.? *Phyciodes liriope liriope* (Cramer); Hall, 1929: 64.*Phyciodes (Tritanassa) liriope* (Cramer); Forbes, 1945: 157-158, 188, 190.

♂ forewing 16-17 mm, upperside rather dark fulvous, markings dark brown (? black when fresh); hindwing underside with an irregular reddish discal line. ♀ similar, slightly larger.

*Genitalia.* ♂ tegumen short, fragile, difficult to define; valve with distal section short, apex slightly inturned, harpe rather long; saccus narrow; penis straight, suspensory ligament near mid-point. ♀ genital plate small, ductus not clearly chitinised, bursal support relatively large.

DISTRIBUTION. French Guiana, Guyana, Surinam and N. Brazil.

DISCUSSION. This species is easily confused with *Tegosa orobia*, but *liriope* can be identified by the slightly wavy red line across the discal area on the underside of the hindwing. Forbes (1945: 188-189) discusses the confusion between *liriope* and *claudina* (in which he includes *orobia*).*Ortilia gentina* sp. n.

(Figs 64, 305, 306)

♂ forewing 14-17 mm, upperside ground-colour fulvous-yellow, markings black, slightly variable, wing borders black, 2.5 mm or even more, prominent, subapical band rather irregular, often imperfectly defined medially, extending into submarginal area in s3, some dark striae across cell; hindwing upperside basal area slightly dusky, dark marginal border prominent, including poorly defined submarginal lunules in some specimens, underside postdiscal spots usually well marked.

*Genitalia.* ♂ in dorsal view with organs wider, distal section of valve longer, apex slender, strongly curved inwards, harpe placed further forwards at centre of valve. ♀ not examined.

Holotype ♂, **Brazil**: São Paulo, Anhangahy, xi. 1926 (*R. Spitz* genitalia slide no. 2698) (BMNH).

Paratypes. **Brazil**: 1 ♂, Mato Grosso (genitalia slide no. 826). **Bolivia**: 1 ♂, no further data (genitalia slide no. 1082); 1 ♂, Santa Cruz de la Sierra (genitalia slide no. 825); 1 ♂, Bueyes (genitalia slide no. 1081). **Argentina**: 1 ♂, Tucumán (genitalia slide no. 1083).

**DISTRIBUTION.** Brazil, Argentina (Tucumán), Peru, Bolivia, Paraguay. Collected in November, February, April, July. Probably emerges in two or perhaps three annual broods.

**DISCUSSION.** This species resembles *O. liriopoe* closely. Distinctive features include the paler upperside ground colour, and on the hindwing the better-defined basal dark area. On the hindwing underside the reddish oblique line is prominent in *liriopoe*, and the series of postdiscal spots is obvious in *gentina*, while the oblique line is vestigial and is not prominent. The male genitalia are easily distinguished.

### *Ortilia orthia* (Hewitson) **comb. n.**

(Figs 65, 307)

*Eresia orthia* Hewitson, [1864]: [19], pl. [10], figs 21, 22. **LECTOTYPE** ♂, **BRAZIL**: Minas Geraes (BMNH, Type no. Rh. 8449; Gabriel, 1927: 91), here designated [examined].

*Phyciodes poltis* Godman & Salvin, 1878b: 261; Godman & Salvin, 1882: 200, pl. 21, figs 28, 29; Röber, 1913: 438, pl. 88, row i [fig. 3] (very poor fig.); Hall, 1929: 81). **LECTOTYPE** ♂ [**BRAZIL**: Minas Geraes] (BMNH, Type no. Rh. 8450; Gabriel, 1927: 98), here designated [examined]. [For locality see Hall, 1929: 81.]

*Phyciodes orthia* (Hewitson) Röber, 1913: 438, pl. 89, row h [figs 8–10]; Hall, 1929: 80; Hayward, 1964b: 346, pl. 18, fig. 17.

*Phyciodes orthia* ab. *evanescens* Röber, 1913: 438. Syntype(s), [? **BRAZIL**] (depository unknown).

*Phyciodes orthia* f. *roeberi* Hall, 1935: 221. Holotype ♀, **BRAZIL**: Santa Maria, Rio Grande do Sul, 1200 ft [420 m], i. 1920 (*A. Hall*) (BM, Brighton).

*Phyciodes (Tritanassa) orthia* (Hewitson); Forbes, 1945: 177, 190.

♂ forewing 15 mm, upperside dark brown, markings pale yellow, sometimes shading to white, cell-spot well developed, postdiscal spots in s1b, s2 and s3 rather small with smaller spot placed more distally and well separated in s1b; hindwing discal band usually darker orange anteriorly in s7. ♀ larger, submarginal markings often better defined.

*Genitalia.* ♂ like *O. liriopoe*, in dorsal view slightly narrower, harpe shorter, straight, posterior border of juxta gently convex.

**DISTRIBUTION.** S. Brazil, Paraguay, Argentina.

**NOTE.** The form *evanescens* (black and white) is mostly found in Minas Gerais (Prof. Keith Brown, pers. comm.).

### *Ortilia orticas* (Schaus) **comb. n.**

(Figs 71, 308–309)

*Phyciodes orticas* Schaus, 1902: 394; Röber, 1913: 445. Holotype ♂, **BRAZIL**: Castro, Parana (USNM, Type no. 5888) [examined].

*Phyciodes orticas orticas* Schaus; Hall, 1929: 105.

*Phyciodes (Tritanassa) orticas orticas* Schaus; Forbes, 1945: 182, 190.

♂ forewing 18 mm, upperside black, markings white, cell-spot minute, vestigial, oblique bar in s5–s7 short, postdiscal spot in s1b–s3 large; hindwing upperside white discal band crossed by black veins, submarginal lunules vestigial or absent; forewing underside base orange-fulvous. ♀ similar, slightly larger.

*Genitalia.* ♂ in dorsal view like *O. orthia* but base wider, discal section of valve longer. ♀ bursal support well chitinized.

**DISTRIBUTION.** Brazil (Parana, Rio de Janeiro, etc.), Argentina (Entre Rios).

*Ortilia sejona* (Schaus) comb. n., sp. rev.

(Figs 66, 310)

*Phyciodes sejona* Schaus, 1902: 393; Röber, 1913: 438, pl. 89, row i [figs 2, 3] (♂, ♀). Holotype ♀, BRAZIL: São Paulo (USNM, Type no. 5886).

[*Phyciodes velica velica* (Hewitson); Hall, 1929: 81. Misidentification.]

Upperside brown, markings yellow, like *Telenassa teletusa*. ♂ forewing 16–17 mm, cell spot prominent, submarginal markings present, postdiscal oval mark in s1, s2 and s3 entire (distinction from *O. orthia*); hindwing upperside transverse band usually wide, blending anteriorly with submarginal lunules in s7; underside pale transverse band well defined. ♀ similar, larger.

*Genitalia*. In dorsal view ♂ organs narrow, like *O. orticas*, tegumen fragile, vincula wide, posterior section of valve relatively stout. ♀ not examined.

**DISTRIBUTION.** Brazil, restricted to the states of Goiás and Minas Gerais, to the border of Parana and Santa Catarina (*Ebert*).

**DISCUSSION.** This species was misidentified by Hall as a synonym of *velica*, and consequently overlooked by Forbes (1945).

*Ortilia velica* (Hewitson) comb. n.

(Figs 67, 311, 312)

*Eresia velica* Hewitson, [1864]: [20], pl. 10, figs 25, 26.

♂ forewing 15 mm, upperside dark brown, with or without fulvous markings arranged as in *O. orthia*. ♀ similar, usually larger.

*Genitalia*. ♂ in dorsal view, like *O. orthia*, harpes slightly curved, vincula appear wider.

**DISTRIBUTION.** S. Brazil, Uruguay, Paraguay, Argentina.

Two subspecies with similar genitalia.

*Ortilia velica velica* (Hewitson)

*Eresia velica* Hewitson, [1864]: [20], pl. [10], figs 25, 26. LECTOTYPE ♂, [BRAZIL: Minas Gerais] (BMNH, Type no. Rh. 8451; Gabriel, 1927: 121], here designated [examined].

*Phyciodes velica velica* (Hewitson) Röber, 1913: 438; Hall, 1929: 81; Forbes, 1945: 172, 175, 179, 190.

♂ forewing 16 mm, markings of upperside dull fulvous, arranged as in *O. orthia*, hindwing upperside fulvous discal area wide.

**DISTRIBUTION.** S. Brazil (only in southern Minas Gerais and São Paulo), and Uruguay (here often with dark upperside suffusion forming transition to following subspecies).

*Ortilia velica durnfordi* (Godman & Salvin)

*Phyciodes durnfordi* Godman & Salvin, 1878b: 263. LECTOTYPE ♂, ARGENTINA: Buenos Aires (*H. Durnford*) (BMNH, Type no. Rh. 8452; Gabriel, 1927: 43), here designated [examined].

*Phyciodes velica dictynna* Röber, 1913: 438, pl. 89, row k [figs 5–7]. Syntypes ♂, ♀, BRAZIL; ARGENTINA: Palermo, Gardens of Agriculture (*Seitz*) (? MNHU, Berlin).

*Phyciodes velica durnfordi* Godman & Salvin; Hall, 1929: 82; Forbes, 1945: 179; Hayward, 1964b: 348, pl. 18, fig. 19.

♂ upperside fulvous markings reduced by dark suffusion, markings almost absent in extreme examples.

**DISTRIBUTION.** Brazil (São Paulo and southwards), Argentina, Uruguay and Paraguay. Specimens with intermediate characters common in northern localities.



*Ortilia zamora* (Hall) **comb. n., stat. rev.**

(Figs 68, 313)

*Phyciodes zamora* Hall, 1917: 161. Lectotype ♂, 'Venezuela' [S. Brazil] (BM, Brighton), designated by Hall, 1929: 105 [examined].

*Phyciodes orticas zamora* Hall; Hall, 1929: 105, pl. 1, fig. 13 (♂); Forbes, 1945: 182.

♂ forewing 19 mm, outer margin slightly excavated, upperside dark brown, markings orange-yellow, like *O. orticas* but with vestiges of basal markings, small spot present in cell before disco-cellular vein, a smaller spot on the vein, postdiscal markings in darker tone of orange-brown in s3-s5; hindwing yellow discal band as in *O. orticas*, extending to inner margin, not crossed by dark veins. ♀ not seen.

*Genitalia.* ♂ like *O. orticas*, tegumen very fragile, short, posterior border of juxta gently curved, saccus tapering.

**DISTRIBUTION.** Brazil: restricted to the mountains from central Espirito Santo southwards to central São Paulo (Prof. Keith Brown, Pers. comm.).

*Ortilia dicoma* (Hewitson) **comb. n.**

(Figs 69, 314-316)

*Eresia dicoma* Hewitson, [1864]; [23], pl. [12], figs 41, 42. LECTOTYPE ♂, [BRAZIL] (BMNH, Type no. Rh. 8546; Gabriel, 1927: 40), here designated [examined].

*Phyciodes dicoma* (Hewitson) Röber, 1913: 445, pl. 90, row g [fig. 6] (♂); Hall, 1929: 138; Forbes, 1945: 187, 190; Hayward, 1964b: 360, pl. 18, fig. 18.

♂ forewing 19 mm, elongate, upperside orange-yellow, costa and outer margin bordered black, a black oblique postdiscal bar; hindwing with outer margin broadly black and base narrowly black. ♀ similar, upperside with fulvous tone paler.

*Genitalia.* ♂, in dorsal view, base wide, then tapering, valve apex strongly inturned, posterior border of juxta convex with deep central notch, harpe slender, inclined at an angle of 45°, penis with apical section slender, lacking ostium-keel. ♀ like *O. velica*.

**DISTRIBUTION.** S. Brazil (from Dist. Federal southwards to Rio Grande do Sul, always in forest), Paraguay, Argentina (Hayward, 1964b: 361).

*Ortilia polinella* (Hall) **comb. n.**

(Figs 70, 317)

*Phyciodes polinella* Hall, 1928a: 12, Hall, 1929: 139, pl. 2, figs 10 (♂), 11 (♀); Forbes, 1945: 188, 190. Holotype ♀, BRAZIL: San Jacintho Valley, Minas Geraes (BMNH) [examined].

♂ forewing c. 15 mm, upperside dark brown, obscurely marbled with orange; hindwing with rather broad discal orange band (Fig. 70), and faint, very fine submarginal lunules; brownish orange below, with the fine pattern rather indistinct. ♀ forewing 16-17 mm, upperside dark brown, markings orange-yellow, postdiscal spot in s1b-s2 present, paler spot in s4; hindwing discal band orange-yellow, becoming pale yellow and very narrow near inner margin; underside pattern rather better defined than in male.

*Genitalia.* ♂ like *O. dicoma*, in dorsal view tegumen fragile, narrow, with central sulcus, valve apex less curved, harpe more massive. (N. B. tegumen slightly distorted in figure.)

**DISTRIBUTION.** Brazil: Minas Geraes, Rio de Janeiro and Espirito Santo. A rare and local species; there are three males and six females in the BMNH.

**DISCUSSION.** Hall's original description refers only to the female sex, the 'type ♀' of the original description being stated to be in the Rothschild (Tring) collection. Later, Hall (1929: 139) claims that the holotype is a male in the National (BMNH) collection. Finally, I have seen a male in the Booth Museum, Brighton (Hall coll.) which also appears to be a 'holotype'! The true holotype ♀, labelled 'type' by Hall and now in the BMNH, has now been clearly and unequivocally so labelled.

***Ortilia ithra* (Kirby) comb. n.**

(Figs 72, 318–320, 490)

[*Argynnis ianthe* (Fabricius); Godart, [1824]: 818. Misidentification.][*Acca hera* (Cramer); Hübner, [1826]: pl. 44, figs 1–4. Misidentification.]*Nepesithra* Kirby, 1871: 252. Syntypes ♂, ♀, BRAZIL (lost). [*N. ithra* was named by reference to Hübner's misidentified figures of *Papilio* (as *Acca*) *hera* Cramer; these specimens are lost.]*Phyciodes ithra* (Kirby) Kirby, 1900: 18; Hayward, 1964: 357, pl. 18, figs 20 (♂), 21.[*Phyciodes ianthe ianthe* (Fabricius); Röber, 1913: 443, pl. 90, row d [fig. 9], row e [fig. 1]. Misidentification.]*Phyciodes ianthe atra* Röber, 1913: 443, pl. 90, row b [fig. 7], row c [fig. 8]. [Hall, 1929: 104 considers *atra* to be a misprint for *ithra*.]*Phyciodes janthe* ab. *nigra* Giacomelli, 1928: 679. Holotype ♂, ARGENTINA: Rioja, Cosquin (depository unknown).*Phyciodes ithra rufocincta* Hall, 1928a: 11; Hall, 1929: 104, pl. 1, fig. 3; Forbes, 1945: 182. Holotype ♂, ARGENTINA: Cordoba Hills (BM, Brighton) [examined]. **Syn. n.***Phyciodes ithra ithra* (Kirby); Hall, 1929: 103; Forbes, 1945: 182, 187, 190.*Phyciodes janthe* ab. *schaeferi* Köhler, 1945: 256, pl. 20, fig. 4. Holotype, ARGENTINA: Catamarca, Sierra de Ambato, 2000 m ('Schaeffer Coll.').

♂ forewing 17–20 mm, elongate, upperside markings white, cell-spot small, postdiscal spot in s1b, s2 s3 large; hindwing upperside discal band narrow, crossed by dark veins, small submarginal spot in s7 clearly marked, other submarginal spots variable, well developed in Mato Grosso specimens; forewing underside base bright orange-yellow, enclosing white, dark-ringed cell-spot. ♀ similar.

**Genitalia.** ♂ organs large, in dorsal view tegumen short, but well defined, scaphial extension very short, saccus long, massive, apical section of valve short; penis in side view slender. ♀ bursal duct partly chitinized.**DISTRIBUTION.** Brazil, Argentina, Paraguay, Uruguay, Bolivia. Absent from most western regions, but one of the commonest and most widely distributed species in the East.**NOTE.** Two figures giving the dorsal view of male genitalia are included. In Fig. 318 from Paraguay, the apical section of the valve is slightly longer and the harpe less massive than that shown in Fig. 319 from the Mato Grosso.***TISONA* gen. n.**Type-species: *Phyciodes saladillensis* Giacomelli. Gender: feminine.The single known species is a small butterfly with superficial resemblance to species of *Tegosa*, but differing from all other known Phycioidini in wing-markings and in genital structure.

♂ upperside of both wings orange-fulvous, markings black in a rather complicated pattern defining a series of submarginal spots on both wings. Underside paler, yellow, markings orange, hindwing with a prominent brown postdiscal stripe. Sexes similar.

**Genitalia.** ♂, in dorsal view, tegumen bilobed, short and very fragile, valve wide, tapering abruptly to a short posterior process, posterior border of juxta convex, saccus entire (lingulate) with a shallow terminal notch; penis about 3 times the length of valve, slender, apex with 2 twisted tapering processes. ♀ bursal duct partly chitinized, bursal support well formed.***Tisona saladillensis* (Giacomelli) comb. n.**

(Figs 73, 74, 321–324)

*Phyciodes saladillensis* Giacomelli, 1911: 22.

For description of the species, the main features are covered in the generic diagnosis.

**DISTRIBUTION.** N. Argentina, Bolivia.

Two subspecies with similar genitalia.

*Tisona saladillensis saladillensis* (Giacomelli)

(Figs 73, 321–324)

*Phyciodes saladillensis* Giacomelli, 1911: 22; Röber, 1913: 437, pl. 89, row f [figs 1, 2]; Hall, 1929: 55; Forbes, 1945: 187, 190; Hayward, 1964b: 355, pl. 18, fig. 8 (♂). Holotype (sex ?), ARGENTINA: Saladillo-Santa Cruz (MACN, Buenos Aires).

♂ forewing 17 mm, upperside bright fulvous yellow, black markings heavy and complex on both wings.

DISTRIBUTION. N. Argentina: Tucumán, Catamarca, La Rioja, Salta.

*Tisona saladillensis clarior* subsp. n.

(Fig. 74)

Differs from nominate race in the following aspects: upperside paler yellow, black markings more delicate; ♂ hindwing upperside with wide discal area unmarked, black postdiscal lunules vestigial or absent, but series of submarginal lunules complete; underside paler, discal band grey-brown. ♀ not available.

*Genitalia* examined (genitalia prep. no. 878).

Holotype ♂, **Bolivia**: Cochabamba, Yunga del Espiritu Santo (*P. Germain*) (BMNH).

Paratypes. **Bolivia**: 3 ♂, same data as holotype; 2 ♂, 'Bolivia', ex *Germain*; (BMNH).

DISTRIBUTION. Bolivia: Cochabamba.

*TEGOSA* gen. n.

Type-species: *Acraea claudina* Eschscholtz. Gender: feminine.

Small butterflies, forewing length 13–18 mm, uppersides characteristically yellow-buff, wing margins black, forewing with an oblique, black postdiscal bar, often incomplete, enclosing a sub-apical band or bar of ground-colour. Venation and other anatomical characters show the usual tribal features, forewing outer margin gently convex, never excavate. Sexes similar, or nearly so.

*Genitalia*. ♂ tegumen well formed, chitinized, followed by a relatively long scaphial extension, well defined, ending abruptly with minute spines at the posterior lateral angles, which appear in dorsal view as spiny bosses; valves oval, tapering to a slender terminal process with a small tooth immediately above it; harpe slender, in dorsal view usually almost straight; saccus deeply cleft or entire, or with a terminal notch; penis straight, with a small ostium-keel. The shape of the posterior border of the juxta may be useful. ♀ (examined in *T. fragilis* and *T. anieta*) with bursal duct chitinized, arising from a deep antevaginal pit, bursal support globular.

DISTRIBUTION. The species are very widely distributed through Central and South America, from southern Mexico to about 43°S in Argentina and Peru.

DISCUSSION. The male genitalia show a striking difference between the species of the eastern and western regions of South America. In the eastern region, from Trinidad across Brazil and Argentina, southwards to Buenos Aires, and including part of Venezuela, Paraguay and Bolivia, the saccus is deeply cleft and the tegumen elongate, wide, tapering gradually to an abrupt, truncate apex, with minor variation in all eastern species, and including two rare species endemic in Ecuador and N. Peru. In the western region, from Mexico through Central America and along the Andes, the saccus is entire, the tegumen and scaphial extension raquet-shaped, i.e. the extension abruptly tapered and then expanded again to its apex, in dorsal view appearing forked with spiny boss at the end of each lateral rib. These differences might suggest a generic distinction, but there are some species with intermediate characters and the wing-patterns are so similar that a close relationship is clearly present between all species within the group.

While there is not an obvious mimetic association with protected species, there is a remarkable similarity in wing-markings between *Tegosa claudina* and two species of a distinct genus, *Ortilia liriope* and *O. gentina*. The general structure of the genitalia in *Tegosa* suggests

relationship with *Eresia*, and it is interesting that the colour scheme and upperside wing-markings of *Eresia selene* are similar to those of *Tegosa*, e.g. *T. etia*, probably indicating a mimetic relationship.

The male genitalia of *Tegosa* species are among the smallest known among the Rhopalocera. Examination is difficult as the globular shape does not present a flat surface to support the parts in a constant position for close comparison. The organs are too small for successful dissection, and they should be mounted entire. A dorsal view showing the shape of the tegumen and the scaphial extension is the most helpful.

### Key to species of *Tegosa*

*Note.* It has not been practicable to include *T. tissoides* (p. 120) and *T. pastazena* (p. 125) in this key.

- |    |  |  |
|----|--|--|
| 1  | Male tegumen racquet-shaped (Fig. 346)   | 2  |
| -  | Male tegumen not racquet-shaped (Fig. 334)   | 12   |
| 2  | Upperside unmarked except forewing apex black, hindwing outer margin with or without black marginal border | <i>guatemalena</i> (p. 125)                        |
| -  | Upperside not so marked  | 3  |
| 3  | Forewing upperside black costal bar incomplete or vestigial  | <i>anieta luka</i> (p. 126)                        |
| -  | Forewing not so marked   | 4  |
| 4  | Wing-base, costa and marginal borders broadly black, postdiscal bar isolating narrow subapical orange band | <i>anieta anieta</i> (p. 126)                      |
| -  | Upperside not so marked  | 5  |
| 5  | Like <i>T. anieta anieta</i> , but black upperside markings extended, forewing pointed                     | <i>anieta cluvia</i> (p. 126)                      |
| -  | Like <i>T. anieta cluvia</i> , but forewing upperside with small orange cell-spot                          | <i>nazaria</i> (p. 127)                            |
| 6  | Upperside ground-colour pale yellow  | <i>flavida</i> (p. 124)                            |
| -  | Upperside not so marked  | 7  |
| 7  | Upperside forewing with additional markings at base and in cell  | <i>ursula</i> (p. 124)                             |
| -  | Forewing not so marked   | 8  |
| 8  | Upperside hindwing with coloured area reduced to discal band   | 9  |
| -  | Upperside hindwing black   | 11   |
| 9  | Hindwing upperside discal band orange  | <i>nigrella</i> f. <i>niveonotis</i> (p. 128)      |
| -  | Hindwing not so marked   | 10   |
| 10 | Hindwing discal band white   | <i>nigrella</i> f. <i>niveonotis</i> (p. 128)      |
| -  | Hindwing discal band obscured by general fuscous suffusion   | <i>nigrella</i> f. <i>nigrella</i> (p. 128)        |
| 11 | Forewing upperside with orange markings  | <i>etia</i> f. <i>etia</i> (p. 128)                |
| -  | Forewing upperside entirely black  | <i>etia</i> f. <i>tissa</i> (p. 128)               |
| 12 | ♂ tegumen base wide, tapering evenly to truncate apex (Fig. 334)   | 13   |
| -  | ♂ tegumen base wide, tapering abruptly with angle at point of contraction (Fig. 325)                       | 14   |
| 13 | Forewing upperside markings well developed   | <i>orobia</i> (p. 123), <i>infrequens</i> (p. 124) |
| -  | Forewing upperside postdiscal markings vestigial   | <i>fragilis</i> (p. 124)                           |
| 14 | Forewing upperside markings well developed   | <i>claudina</i> (p. 122)                           |
| -  | Forewing upperside markings incomplete   | <i>similis</i> (p. 123)                            |

### *Tegosa claudina* (Eschscholtz) **comb. n.**

(Figs 75, 325, 326)

*Acraea claudina* Eschscholtz, 1821: 212, pl. [8], figs 18a, b. Syntype(s), [ARGENTINA] (depository unknown).

? *Argynnis flavia* Godart, [1824]: 818. Syntype(s), BRAZIL (? MNHN, Paris).

? [*Phyciodes liriopae* (Cramer)]; Hall, 1929: 63, *in part.* Misidentification.]

? *Phyciodes liriopae claudina* (Eschscholtz); Hall, 1929: 65.

? *Phyciodes (Eresia) claudina* (Eschscholtz); Forbes, 1945: 157-160, 188-9, *in part.*

? *Phyciodes claudina* (Eschscholtz); Hayward, 1964b: 334, pl. 18, fig. 9.

Upperside fulvous yellow; ♂ forewing 15-16 mm, cell crossed by black striae, post-discal black bar complete, subapical yellow bar divided into two almost equal areas, wing apex and outer margin black; hindwing black marginal border about 2 mm wide with vestigial submarginal lunules near anal angle,

postdiscal dots in each space almost always present; hindwing underside with reddish striae in a confused pattern, almost always with a small, darker spot at cell-end, postdiscal spots in complete series, spot in s3 emphasised, often with a small dark suffusion. ♀ similar, forewing 18 mm, upperside slightly paler.

*Genitalia.* ♂ in dorsal view, tegumen short, scaphial extension tapered with a blunt lateral angle, spiny bosses well defined as rather small spiny knobs, posterior border of juxta slightly prominent, saccus deeply cleft; penis in side view slender, ostium keel present, morulae small.

**DISTRIBUTION.** Brazil (Parana), Argentina (especially in north-west; Chaco, Resistencia, Villa Ana etc.), Paraguay (common), ? Peru.

**NOTE.** Eight males have been checked by dissection (3 ♂, Paraguay, slide nos 821, 2711, 2763; 1 ♂, Peru, no. 1074; 1 ♂, Brazil, Parana, no. 863; 3 ♂, Argentina, slide nos 2764, 2766(1), 2766(2)).

### *Tegosa similis* nom. n.

(Figs 76, 327–333)

*Papilio thymetus* Fabricius, 1787: 30. LECTOTYPE ♂, [BRAZIL: Minas Geraes] 'Indiis' (UM, Glasgow), here designated [examined]. [Junior primary homonym of *Papilio thymetus* Cramer, 1777.]

[*Phyciodes fragilis* (Bates); Röber, 1913: 445, pl. 89, row a [fig. 9] (♂). Misidentification.]

? *Phyciodes liriopae thymetus* (Fabricius); Hall, 1929: 66.

[*Phyciodes (Eresia) claudina fragilis* (Bates); Forbes, 1945: 157–160. 189. ? Misidentification.]

Upperside usually pale orange-yellow; ♂ forewing 16–18 mm, costa dark with striae running into cell, postdiscal dark bar incomplete, often vestigial, then defined only by a mark on costa, apex and outer margin dark, subapical yellow band not divided; hindwing dark marginal border prominent, including marginal lunules, dark postdiscal dots usually present in each space; underside paler yellow, with faint brownish markings. ♀ similar, slightly larger.

*Genitalia.* ♂ tegumen short, in dorsal view scaphial extension tapered with blunt lateral angle, apex truncate, spiny bosses conspicuous, close together, lying transversely, posterior of juxta with low central prominence, saccus cleft often incomplete. ♀ ductus chitinized, arising from a deep pit, surmounted by globular bursal support.

**DISTRIBUTION.** Trinidad, Brazil, N. Argentina, Venezuela, Colombia, Guatemala, Peru, Ecuador, Cayenne, Paraguay, Mexico.

**NOTE.** Identification has been confirmed by genital examination of the following specimens. Mexico, Santos (slide no. 894); Colombia, Cauca V. (no. 2716); Venezuela (no. 856); Peru, Huancamayo (no. 2759); Ecuador (no. 2715); Guatemala (no. 858); Brazil, Para (no. 874); Trinidad. (no. 893); Brazil, Bahia (♀, slide no. 1080); Rio de Janeiro (no. 2701).

### *Tegosa orobia* (Hewitson) comb. n., sp. rev.

(Figs 77, 334–336)

*Eresia orobia* Hewitson, [1864]: [19], pl. [10], figs 23, 24. LECTOTYPE ♀, [BRAZIL] (BMNH, Type no. Rh. 8532; Gabriel, 1927: 91), here designated [examined].

[*Phyciodes liriopae claudina* (Eschscholtz); Röber, 1913: 435, pl. 89, row a [fig. 4] (♀). Misidentification.]

*Phyciodes liriopae orobia* (Hewitson); Röber, 1913: 435, pl. 89, row b [fig. 7].

*Phyciodes liriopae claudina* f. *orobia* (Hewitson); Hall, 1929: 66.

? *Phyciodes liriopae claudina* ab. *immaculata* Hayward, 1935: 223. Holotype, ARGENTINA: Santiago del Estero ('Breyer Coll.').

*Phyciodes (Eresia) claudina anieta* ab. *orobia* (Hewitson); Forbes, 1945: 160, 189.

Upperside fulvous-yellow to darker orange-fulvous; ♂ forewing 15–19 mm, black markings rather extensive with black striae at wing-base and in cell, subapical orange bar divided into two or three areas; hindwing upperside marked with basal striae, postdiscal dots and submarginal lunules; hindwing underside with brown markings, a dark marginal patch in s4 often extended basally.

*Genitalia.* ♂ in dorsal view, tegumen wide, scaphial extension evenly tapered to truncate apex, terminal bosses appearing as small, round spiny knobs, posterior border of juxta gently convex, harpe slender, saccus deeply cleft; penis slender, ostium keel small. ♀ not figured.

**DISTRIBUTION.** Brazil (Parana etc.), Paraguay (Sapucay), Argentina (Buenos Aires).

*Tegosa fragilis* (Bates) **comb. n., stat. rev.**

(Figs 78, 337, 338)

*Melitaea fragilis* Bates, 1864b: 189. LECTOTYPE ♂, BRAZIL: banks of Cupari, branch of the Tapajos (H. W. Bates) (BMNH, Type no. Rh. 8531; Gabriel, 1927: 52), here designated [examined].  
 [*Phyciodes guatemalena* (Bates); Röber, 1913: 435, pl. 89, row b [figs 1–3]. Misidentification.]  
 [*Phyciodes liriopae thymetus* (Fabricius); Hall, 1929: 66. Misidentification.]  
*Phyciodes* (*Eresia*) *claudina fragilis* (Bates); Forbes, 1945: 160, 189.

Upperside fulvous-yellow, markings black; ♂ forewing 15–17 mm, elongate, costa narrowly dark with black striae running into cell, postdiscal bar incomplete, dark suffusions at wing-bases minimal; hindwing underside markings yellow-brown, a strongly convex postdiscal line usually well developed. ♀ similar, upperside markings better defined.

*Genitalia*. ♂ in dorsal view like *T. orobia*, tegumen evenly tapering to truncate apex, saccus deeply cleft; penis in side view slender.

DISTRIBUTION. Venezuela (Siapure), Brazil.

NOTE. Identification has been confirmed by genitalic examination of the following specimens: 2 ♂, Venezuela, Siapure (slide nos 848, 866); 1 ♂, Brazil, Alta Mira (no. 2595).

*Tegosa infrequens* sp. n.

(Figs 79, 339, 340)

♂ upperside fulvous, like *T. anieta*, forewing 16 mm, oblique postdiscal bar complete, enclosed fulvous bar not divided; hindwing underside markings very faint, pale orange-brown. ♀ slightly larger, markings as in ♂.

*Genitalia*. ♂ like *T. claudina*, apex of scaphial extension of tegumen slightly narrower, posterior border of juxta with low central prominence; penis slender. ♀ not dissected.

Holotype ♂, **Brazil**: São Paulo, Bahuru (*Hempel*) (genitalia slide no. 1075) (BMNH).

Paratypes. **Brazil**: 2 ♂, Petropolis (genit. sl. nos 2764); 2 ♂, same data as holotype (genit. sl. no. 857); 1 ♂, Minas Gerais, San Jacintho Valley (genit. sl. no. 2765); 1 ♀, Quipapa, Pernambuco. **Bolivia**: 2 ♂, R. Tanampaya (genit. sl. no. 2714, 2759). **Peru**: 1 ♂, Chanchamayo (genit. sl. no. 1074). (All in BMNH.)

DISTRIBUTION. Brazil, Bolivia (R. *Tanampaya*), Peru (Chanchamayo).

*Tegosa ursula* (Staudinger) **comb. n.**

(Figs 80, 341)

*Phyciodes ursula* Staudinger, 1894: 70, pl. 2, fig. 3; Röber, 1913: 435, pl. 89, row c [fig. 3] (♂); Hall, 1929: 54; Forbes, 1945: 158, 189; Hayward, 1964b: 333, pl. 18, fig. 11 (♂). 1 ♂, 2 ♀ syntypes, **BOLIVIA**: Cocapata; Bueyes (*Garlepp*) (MNHU, Berlin).

♂ forewing 15–16 mm, upperside fulvous with irregular reticulate markings black; hindwing black marginal lunules and marginal border conspicuous. ♀ similar.

*Genitalia*. ♂ tegumen wide in dorsal view, slightly tapered posteriorly, apex truncate, terminal bosses represented by slightly oblique dense bars each with 5 or 6 short teeth on each side, dorsal and ventral plates lightly chitinized, harpes sharply curved, saccus deeply cleft. ♀ not examined.

DISTRIBUTION. Argentina (Tucuman, Salta, Jujuy—specimens in BMNH), Bolivia (no specimens seen).

*Tegosa flavida* (Hewitson) **comb. n.**

(Figs 81, 342)

*Eresia flavida* Hewitson, [1868]: [34], pl. [19], fig. 61. LECTOTYPE ♂, **ECUADOR** (BMNH, Type no. Rh. 8527; Gabriel, 1927: 51), here designated [examined].

*Phyciodes albescens* Röber, 1913: 444, pl. 90, row f [fig. 4]. Holotype ♀, **ECUADOR**: Quevedo (*Buchwald*) (BMNH) [examined].

*Phyciodes flavida* (Hewitson) Röber, 1913: 444, Hall, 1929: 75; Forbes, 1945: 158, 189.

♂ forewing 14–15 mm, upperside pale yellow, apex and outer margin dark brown (? black when fresh); hindwing outer margin dark; no other markings. ♀ similar, slightly larger.

*Genitalia.* Like *T. claudina*, ♂ tegumen moderately tapered in dorsal view, spinous areas of scaphial extension small, approximately rounded, harpes slender, slightly curved, saccus pedunculate, partially cleft (single preparation). ♀ not examined.

DISTRIBUTION. Ecuador, N. Peru.

*Tegosa tissoides* (Hall) comb. n.

(Figs 90, 343)

*Phyciodes tissoides* Hall, 1928a: 11; Hall, 1929: 72, pl. 1, fig. 1 (♂); Forbes, 1945: 158, 189. Holotype ♂, ECUADOR: Angamarca, Salidero, 350 ft [110 m] (BMNH) [examined].

♂ forewing 14 mm, uppersides of both wings black with brown reflections; forewing underside brown, marginal markings vestigial if present; hindwing underside anal area and disc white shading into brown near outer margin.

*Genitalia.* In dorsal view ♂ tegumen slightly elongate, tapered, scaphial extension with terminal bosses not prominently spined but appearing on each side as oblique oval structures; harpe relatively stout; saccus elongate, entire, with shallow terminal notch, preparation no. 1117 (single preparation).

DISTRIBUTION. Ecuador. BMNH collection includes 4 males with holotype, all from Angamarca, 110 m, February (Hall, 1929: 73 records one of these specimens as a female).

*Tegosa pastazena* (Bates) comb. n., stat. n.

(Figs 82, 344, 345)

*Melitaea liriopae* var. *pastazena* Bates, 1864b: 189 (footnote). LECTOTYPE ♂, ECUADOR: Canelos, banks of the Pastaza (*Spruce*) (BMNH, Type no. Rh. 8530; Gabriel, 1927: 94), here designated [examined].

*Phyciodes liriopae pastazena* (Bates); Hall, 1929: 67.

*Phyciodes* (*Eresia*) *claudina anieta* f. *pastazena* (Bates); Forbes, 1945: 160.

♂ forewing 16–17 mm, like *T. anieta* but slightly larger; upperside tawny orange, costa black to origin of oblique costal bar, enclosed orange subapical band not divided, outer margin broadly black; hindwing dark border along outer margin narrow but clearly defined; hindwing underside postdiscal dark spots well developed in s1b–s6. ♀ similar, slightly larger.

*Genitalia.* ♂ tegumen rather narrow, scaphial extension narrow, elongate, lateral walls almost parallel, each posterior spiny angle scarcely defined as a boss, saccus single with terminal notch.

DISTRIBUTION. Bolivia, Peru, Ecuador.

DISCUSSION. This species appears to be very local but widely distributed in the south-western area of generic distribution. In four specimens examined the characters of the genitalia are constant and the external markings also recognisable, but identification must be confirmed by examination of the genitalia.

*Tegosa guatemalena* (Bates) comb. n., stat. n.

(Figs 83, 346–348)

*Melitaea fragilis* var. *guatemalena* Bates, 1864b: 192–193. LECTOTYPE ♂, GUATEMALA: central valleys (BMNH, Type no. Rh. 8529; Gabriel, 1927: 56), here designated [examined].

[*Phyciodes fragilis* (Bates); Godman & Salvin, 1882: 198, pl. 21, fig. 23 (♂). Misidentification.]

[? *Phyciodes liriopae pastazena* (Bates); Röber, 1913: 435, pl. 89, row b, [fig. 4] (♂). Misidentification.]

*Phyciodes liriopae guatemalena* (Bates); Hall, 1929: 67.

*Phyciodes* (*Eresia*) *claudina guatemalena* (Bates); Forbes, 1945: 160, 189.

♂ forewing 16–17 mm, upperside orange-yellow, almost unmarked, apex slightly shaded black; hindwing with narrow dark marginal border in some specimens; underside with confused pale reddish striae. ♀ slightly larger, forewing upperside dark markings more complete.

*Genitalia.* ♂ tegumen wide, tapered rather abruptly to narrow scaphial extension, apex forked and expanded with spiny terminal bosses on each side, posterior border of juxta gently curved, saccus conical, entire or rarely apex slightly notched. ♀ not examined.

DISTRIBUTION. Guatemala, Mexico, Ecuador, Belize.

*Tegosa anieta* (Hewitson) **comb. n., stat. rev.**

(Figs 84–88, 349–356)

*Eresia anieta* Hewitson, [1864]: [23].

♂ forewing 14–15 mm, upperside orange-fulvous, costa, base and wing-borders black, oblique postdiscal bar variable, typically well developed but incomplete or even vestigial in many areas, subapical orange band, when defined, rather small, narrow, rarely partly divided; hindwing margin black, otherwise unmarked. ♀ upperside usually slightly paler, often with small submarginal yellowish spots in s5 and s6.

*Genitalia.* ♂ tegumen wide, abruptly tapered to a narrow neck and expanded again at apex, saccus single, posterior border of juxta almost straight, penis straight, slender, morula small. ♀ not examined.

Four subspecies.

*Tegosa anieta anieta* (Hewitson)

(Figs 84, 85, 349, 350, 351, 355, 356)

*Eresia anieta* Hewitson, [1864]: [23], pl. [12], figs 43, 44. LECTOTYPE ♂, VENEZUELA: Caraccas (BMNH, Type no. Rh. 8528; Gabriel, 1927: 14), here designated [examined].

*Phyciodes anieta* (Hewitson) Godman & Salvin, 1882: pl. 21, fig. 20 (♂); Röber, 1913: 435, pl. 89, row a [fig. 6], row b [fig. 5, 6].

*Phyciodes liriopae anieta* (Hewitson); Hall, 1929: 68.

*Phyciodes (Eresia) claudina anieta* (Hewitson); Forbes, 1945: 159, 189.

♂ upperside with all black markings well defined; forewing subapical orange band not divided; hindwing postdiscal black dots and vestiges of submarginal lunules often present.

*Genitalia.* As described above.

DISTRIBUTION. Panama, Costa Rica, Venezuela.

*Tegosa anieta cluvia* (Godman & Salvin)

(Figs 86, 352, 353)

*Phyciodes cluvia* Godman & Salvin, 1882: 198, pl. 21, figs 21, 22; Röber, 1913: 435; Hall, 1929: 70. LECTOTYPE ♂, GUATEMALA: Cerro Zunil (*Champion*) (BMNH, Type no. Rh. 8524; Gabriel, 1927: 32), here designated [examined].

*Phyciodes liriopae* f. *lirina* Röber, 1913: 435. Syntype(s), BOLIVIA (? MNHU, Berlin). **Syn. n.**

*Phyciodes liriopae lirina* Röber; Hall, 1929: 68; Forbes, 1945: 188, 190.

*Phyciodes (Eresia) claudina cluvia* Godman & Salvin; Forbes, 1945: 159, 189.

Like *T. anieta anieta* but upperside with all black markings extended; forewing subapical orange band reduced, often partly divided, discal fulvous area reduced; hindwing marginal black border wide.

*Genitalia.* As described above.

DISTRIBUTION. Guatemala, ? Bolivia.

*Tegosa anieta luka* **subsp. n.**

(Figs 87, 354)

[*Phyciodes liriopae flavia* (Godart); Röber, 1913: 435, pl. 89, row a [fig. 6] (♂). Misidentification.]

♂ upperside fulvous-yellow; forewing costa usually dark to postdiscal bar, the latter, although often extending only halfway across the wing and then tapering to a point, is variable and sometimes vestigial; hindwing underside often with darker marginal shade in s3 and s4. ♀ slightly larger, upperside dark markings often more extensive.



*Genitalia.* Compared with nominate *anieta*, the scaphial expansion may be slightly wider.

Holotype ♂, **Mexico**: Tamazunchale, San Luis Potosé, i.1963 (*E. C. Welling*) (genitalia slide no. 2596) (BMNH).

Paratypes. **Colombia**: 5 ♂ (genitalia slide nos. 1223, 2708, 839, 1224, 2709. **Mexico**: 1 ♀, same data as holotype. **Ecuador**: 2 ♂ (genitalia slide nos. 1068, 886). (All in BMNH.)

**DISTRIBUTION.** Mexico, Panama, Ecuador, Honduras, Belize, Costa Rica, Colombia, Peru. The most widely distributed form of *Tegosa* and often common.

*Tegosa anieta serpia* subsp. n.

(Fig. 88)

♂ forewing 15–16 mm, apex rounded, hindwing relatively small; upperside pale orange-fulvous, black markings not heavy; forewing oblique black postdiscal bar short; hindwing black margin well defined, underside postdiscal ocellar spots well marked in s1b, s1c, and in s2, bordered proximally by darker suffusion. ♀ not identified.

*Genitalia.* ♂ like *T. anieta anieta*.

Holotype ♂, **Peru**: Rio Chuchurras, R. Palcazu, 320 m (*W. Hoffmanns*) (genitalia slide no. 1070) (BMNH).

Paratype. **Bolivia**: 1 ♂, Cochabamba (*Germain*) (genitalia slide no. 2761) (BMNH).

**DISTRIBUTION.** Peru (Tarapoto), Bolivia (Cochabamba), W. Columbia?

**DISCUSSION.** *T. anieta*, in its various forms, is very widely distributed in the western mountains, especially in the form or subspecies *anieta luka*. The relationship of this phenotype remains rather uncertain, with the small difference in genitalia present in most specimens, but wing markings are variable and the transformation series to typical *anieta anieta* appears to be complete. *T. anieta serpia*, which shows quite striking features in wing-shape and markings, is perhaps specifically distinct, but with only 7 male specimens I think it is better included with *anieta* in the absence of more information about distribution.

*Tegosa nazaria* (Felder & Felder) comb. n., stat. rev.

(Figs 89, 357, 358)

*Eresia nazaria* Felder & Felder, 1867: 394. LECTOTYPE ♂, COLOMBIA: Bogotá (*Lindig*) (BMNH), here designated [examined].

*Phyciodes mazaria*; Kirby, 1871: 172. [Misspelling.]

*Phyciodes nazaria* (Felder & Felder); Röber, 1913: 439; Hall, 1929: 69, pl. 1, fig. 12 (♂).

*Phyciodes aquila* Hall, 1917: 162. 7 ♂ syntypes, COLOMBIA: El Baldio, 5400 ft [1750 m] (BM, Brighton) [examined].

*Phyciodes (Eresia) claudina nazaria* (Felder & Felder); Forbes, 1945: 159, 189.

♂ forewing 16 mm, upperside base broadly black, extending across cell, a small orange cell-spot present, black marginal borders wide, orange discal area extending from inner margin to v3, subapical orange band composed of 3 small spots; hindwing base and outer margin broadly black, vestigial submarginal lunules present. ♀ similar.

*Genitalia.* ♂ in dorsal view like *T. anieta*, scaphial extension wider, terminal spiny bosses small, saccus single with small apical notch.

**DISTRIBUTION.** Colombia.

*Tegosa etia* (Hewitson) comb. n., stat. rev.

(Figs 91, 92, 359, 360)

*Eresia etia* Hewitson, [1868]: [33], pl. [19], figs 56, 57. LECTOTYPE ♂, [BOLIVIA] ('Ecuador') (BMNH, Type no. Rh. 8526; Gabriel, 1927: 47), here designated [examined].

*Eresia tissa* Hewitson, 1869a: 27 [index]. LECTOTYPE ♂, ECUADOR: Mapoto (*Buckley*) (BMNH, Type no. Rh. 8517; Gabriel, 1927: 119), here designated [examined]. **Syn. n.**

*Phyciodes etia* (Hewitson) Röber, 1913: 445, pl. 90, row g [fig. 1].

*Phyciodes etia selenoides* Hall, 1928a: 11; Hall, 1929: 71, pl. 1, fig. 4 (♂). Holotype ♂, PERU: Cachapoyas (de Mathan) (BMNH) [examined]. **Syn. n.**

*Phyciodes etia etia* (Hewitson); Hall, 1929: 70.

*Phyciodes etia tissa* (Hewitson); Hall, 1929: 72.

*Phyciodes (Eresia) claudina etia* (Hewitson); Forbes, 1945: 159, 189.

*Phyciodes (Eresia) claudina tissa* (Hewitson); Forbes, 1945: 189.

*Phyciodes (Eresia) claudina selenoides* Hall; Forbes, 1945: 159, 189.

♂ forewing 14–15 mm, upperside with or without fulvous discal and subapical markings; underside fulvous markings replaced by paler yellow, forewing margins and all hindwing brown. ♀ similar.

The wing markings of this small species are very variable, with 3 named forms.

1. Fulvous markings present on upperside of forewing only, f. *etia*.
2. Markings present on hindwing, reduced on forewing, f. *selenoides*.
3. Markings present on uppersides of both wings, but partly obscured by dusky suffusion, f. *tissa*.

All forms occur, with intermediates, throughout the range.

**Genitalia.** ♂ like *T. nazaria*, scaphial extension of tegumen shorter and wider, saccus short with apical notch.

**DISTRIBUTION.** In the mountains of Ecuador, Bolivia and Peru.

### *Tegosa nigrella* (Bates) comb. n., stat. rev.

(Figs 93, 94, 361–363)

*Melitaea nigrella* Bates, 1866: 133. LECTOTYPE ♂, GUATEMALA: central valleys (BMNH, Type no. Rh. 8521; Gabriel, 1927: 86), here designated [examined].

*Phyciodes niveonotis* Butler & Druce, 1872: 100; Godman & Salvin, 1882: 200; Röber, 1913: 441, pl. 90, row a [fig. 7] (♂). Holotype '♀' [♂], COSTA RICA: Cartago (*van Patten*) (BMNH, Type no. Rh. 8518; Gabriel, 1927: 87) [examined]. **Syn. n.**

*Phyciodes lutescens* Godman & Salvin, 1882: 199, pl. 21, fig. 26; Röber, 1913: 444. LECTOTYPE ♂, GUATEMALA: Purula (*Champion*) (BMNH, Type no. Rh. 8519; Gabriel, 1927: 76), here designated [examined]. **Syn. n.**

*Phyciodes nigrella* (Bates) Godman & Salvin, 1882: 199, pl. 21, fig. 24 (♂); Röber, 1913: 444, pl. 88, row i [fig. 8].

? *Phyciodes drusinilla* Röber, 1913: 441, pl. 90, row a [fig. 8]. Syntype(s), ARGENTINA (depository unknown).

*Phyciodes nigrella nigrella* (Bates); Hall, 1929: 73.

*Phyciodes nigrella* f. *lutescens* Godman & Salvin; Hall, 1929: 74.

*Phyciodes nigrella niveonotis* Butler & Druce; Hall, 1929: 74.

*Phyciodes (Eresia) claudina nigrella* (Bates); Forbes, 1945: 158–159, 189.

*Phyciodes (Eresia) claudina niveonotis* Butler & Druce; Forbes, 1945: 159, 189.

♂ forewing 14 mm, upperside black, markings white or yellow, large discal spot and small subapical spots; hindwing with coloured discal band on black ground. ♀ similar.

The wing markings vary in colour, with three named forms.

1. Markings more or less obscured by dusky suffusion, f. *nigrella*.
2. Upperside markings white, f. *niveonotis*.
3. Upperside markings yellow, f. *lutescens*.

**Genitalia.** Like *T. anieta*, small, with similar tegumen and scaphial extension raquet-shaped, posterior border of juxta gently convex, harpe almost straight. ♀ not examined.

**DISTRIBUTION.** Guatemala, Costa Rica (f. *niveonotis* only).

**DISCUSSION.** All forms of *T. nigrella* are rare; their distribution and relationships are not well understood. I have not seen any specimen which agrees with the figure of *Phyciodes drusinilla* Röber (1913: 441, pl. 90, row a [fig. 8]), described from Argentina, and included by Hall (1929: 73) as a possible synonym of *nigrella*.

***ERESIA* Boisduval**

*Eresia* Boisduval, [1836]: pl. 11 [= pl. 7B], fig. 8. Type-species: *Nereis eunice* Hübner, by monotypy. Gender, feminine.

Butterflies of moderate size, forewings elongate, upperside markings very varied. In females the forewings are often more ample, apices more rounded, sometimes with striking sexual dimorphism. Astonishing mimicry is a prominent feature, with the genera *Eueides* Hübner, *Ceratonia* Hübner, and *Mechanitis* Fabricius the most frequent models, but a precise specific model is often difficult to establish, especially in western Brazil, N. Peru, Guatemala and Colombia, where many species of various families appear to be unstable. The genus is extensive and includes the largest species of the tribe.

**Genitalia.** In males the outstanding feature is the long scaphial extension which overhangs the valves like a roof (Fig. 383). Slight dorsal constrictions in the lateral margins represent the posterior limit of the 9th tergum (tegumen) in many species, beyond which the anal compartment is roofed by a curtain of delicate fibrous tissue, while the strongly chitinised lateral margins are continued to terminate on each side in a spiny area, forming a prominent boss when viewed from above. The oval valve tapers to a single terminal tooth, usually preceded by one or more smaller teeth upon the costal border. The medial border proximal to the apex usually bears bristles or fine, short spines, not visible in the small figures reproduced on the plates. In all species the sacculus is single, without any cleft or terminal notch; penis straight, sometimes massive, with a small ostium-keel. In dorsal view the female genitalia are sculptured to form a deep pit, from which arises a lightly chitinised cone representing the ductus bursae, surmounted by a cup-shaped bursal support. The post-vaginal scutum is not well developed.

**LARVAL FOOD PLANT.** *Fittonia* (Acanthaceae) is recorded for *E. eunice* by Hayward (1966).

**DISTRIBUTION.** The genus is widely distributed through Central and South America, from Mexico in the north, across the tropical regions to northern Argentina (*E. lansdorfi*), Bolivia and Peru. *Eresia eunice*, with its different modifications, is the most widely distributed species. In the eastern districts of Brazil, and in the Guyanas, it flies with six other species, *E. perna*, *E. lansdorfi*, *E. erysice* (excessively rare), *E. nauplius*, *E. plagiata* and *E. clara*. The remaining species, numbering about 30, are all restricted to Central America and to the countries of western South America, with a marked concentration of species in Colombia, Costa Rica, Venezuela and Peru.

**DISCUSSION.** Throughout the genus polymorphism is often confusing, and associating the sexes correctly may be difficult. In about half the known species the male genitalia do not show specific characters in a convincing manner and therefore are useless for specific definition. In several of the most variable species the status of certain phenotypes is uncertain; these are recorded here as subspecies in all doubtful cases. Specific characters of the male genitalia are probably constant, except in the case of *E. nauplius*, in which confusing variation has been observed.

**Key to species of *Eresia* (males).**

*Note.* It has not been practicable to include *E. coela* (p. 135), *E. mimas* (p. 138), *E. phaedima* (p. 143), *E. melaina* (p. 139), *E. anomala* (p. 141) and *E. etesia* (p. 146) in this key.

The species *E. datis* keys out twice.

- |   |  |                                   |
|---|--|-----------------------------------|
| 1 | Hindwing upperside black with transverse band of white, yellow or fulvous . . . . .      | 2                                 |
| - | Hindwing not so marked . . . . .   | 12                                |
| 2 | Band white or pale cream . . . . .   | 3                                 |
| - | Band yellow or fulvous . . . . .   | 7                                 |
| 3 | Veins crossing white band firmly lined with black . . . . .                              | <i>leititia</i> (p. 133)          |
| - | Veins crossing white band not prominent . . . . .  | 4                                 |
| 4 | Hindwing underside lacks brown basal stripe in s7 . . . . .                              | <i>clara</i> (p. 131)             |
| - | Hindwing underside brown basal stripe in s7 present . . . . .                            | 5                                 |
| 5 | Forewing underside cell-base yellow-brown . . . . .                                      | <i>nauplius nauplius</i> (p. 132) |
| - | Forewing underside cell-base white or pale yellow . . . . .                              | 6                                 |
| 6 | Hindwing upperside transverse white band 3 mm broad, posterior border concave . . . . .  | <i>plagiata</i> (p. 133)          |
| - | Hindwing upperside transverse white band 4 mm broad, posterior border straight . . . . . | <i>nauplius extensa</i> (p. 132)  |

7	Hindwing upperside transverse band yellow . . . . .	8
-	Hindwing upperside transverse band fulvous . . . . .	10
8	Forewing extremely narrow . . . . .	<i>perna</i> (p. 150)
-	Forewing of usual shape . . . . .	9
9	Forewing upperside postdiscal area shaded brown . . . . .	<i>lansdorfi</i> (p. 134)
-	Forewing upperside black, 3 yellow discal spots in oblique row . . . . .	<i>polina</i> (p. 136)
10	Forewing upperside with wide longitudinal fulvous band from base to postdiscal area . . . . .	<i>sestia</i> (p. 134)
-	Forewing not so marked . . . . .	11
11	Hindwing upperside fulvous band tapered from costa to inner margin . . . . .	<i>carne</i> (p. 135)
-	Hindwing upperside slightly or not at all tapered . . . . .	<i>oblita</i> (p. 135)
12	Hindwing upperside disc yellow, crossed by black veins . . . . .	<i>cissia</i> (p. 137)
-	Hindwing not so marked . . . . .	13
13	Forewing upperside black, with or without small fulvous basal suffusion . . . . .	14
-	Forewing not so marked . . . . .	19
14	Forewing with broad yellow oblique discal band . . . . .	15
-	Forewing not so marked . . . . .	16
15	Forewing underside with pale submarginal spots . . . . .	<i>margaretha</i> (p. 144)
-	Forewing underside without submarginal spots . . . . .	<i>datis</i> (p. 143)
16	Forewing upperside with many white or yellowish spots, apex truncate . . . . .	17
-	Forewing upperside markings similar, apex rounded . . . . .	18
17	Forewing underside spots well defined . . . . .	<i>sticta</i> (p. 140)
-	Forewing underside spots replaced by stripes . . . . .	<i>nigripennis</i> (p. 141)
18	Hindwing underside space 8 completely white . . . . .	<i>poecilina</i> (p. 139)
-	Hindwing underside pale basal mark very small (Note: markings variable, fulvous basal area of forewing extensive in some specimens.) . . . . .	<i>ithomioides</i> (p. 140)
19	Forewing upperside fulvous, marked with 2 or 3 black oblique stripes . . . . .	20
-	Forewing not so marked . . . . .	21
20	Forewing proximal black stripe arises very near wing-base . . . . .	<i>alsina</i> (p. 137)
-	Forewing proximal black stripe, sometimes incomplete, arises more distally . . . . .	<i>eutropia</i> (p. 137)
21	Forewing fulvous, apex broadly black with prominent white mark in s4, s5 and s6 . . . . .	<i>emerantia</i> (p. 142)
-	Forewing not so marked . . . . .	22
22	Wings partly translucent . . . . .	23
-	Wings not so marked . . . . .	24
23	Forewing basal and postdiscal black bands present . . . . .	<i>datis</i> (p. 143)
-	Forewing lacking basal and postdiscal markings . . . . .	<i>moesta</i> (p. 142)
24	Hindwing underside grey-brown, veins radiating, heavily scaled black . . . . .	<i>actinote</i> (p. 150)
-	Hindwing not so marked . . . . .	25
25	Hindwing upperside fulvous, with black transverse band . . . . .	26
-	Hindwing not so marked . . . . .	36
26	Forewing exceedingly narrow . . . . .	<i>aveyrona</i> (p. 149)
-	Forewing of usual shape . . . . .	27
27	Forewing apex truncate . . . . .	<i>phillyra</i> (p. 148)
-	Forewing of usual shape, apex rounded . . . . .	28
28	Forewing upperside fulvous basal area restricted to s2 . . . . .	<i>casiphia</i> (p. 147)
-	Forewing upperside fulvous basal area larger, including cell . . . . .	29
29	Forewing upperside apex black . . . . .	30
-	Forewing upperside apex not so marked . . . . .	34
30	Forewing apical black area unmarked . . . . .	31
-	Forewing apical area pale markings more or less developed . . . . .	32
31	Forewing upperside black discal band reduced to 2 black spots . . . . .	<i>pelonia</i> f. <i>pelonia</i> (p. 148)
-	Forewing upperside black discal band wide, prominent . . . . .	<i>eunice esora</i> (p. 145)
32	Forewing upperside black discal band short, restricted to cell . . . . .	<i>erysice</i> (p. 146)
-	Forewing not so marked . . . . .	33
33	Forewing upperside with short black mark in cell, another mark at cell-end, yellow post-discal area extensive . . . . .	<i>quintilla</i> (p. 138)
-	Forewing upperside postdiscal black band complete, reaching outer margin . . . . .	34
34	Forewing upperside apical markings present, forming short, yellow band . . . . .	<i>mechanitis</i> (p. 147)

- Forewing apical markings absent, rarely vestigial . . . . . 35
- 35 Forewing upperside black markings well defined, oblique costal bar complete to outer margin  
  - eunice eunice* (p. 145)
- Forewing upperside black markings reduced, costal black bar incomplete *eunice olivencia* (p. 145)
- 36 Upperside black, with a blue discal band on forewing . . . . . *levina* (p. 150)
- Upperside black, markings fulvous . . . . . 37
- 37 ♂ forewing 27 mm; hindwing with wide fulvous area along distal margin *pelonia* f. *ithomiola* (p. 148)
- ♂ forewing 16 mm; fulvous discal mark on hindwing not extending to outer margin (upperside marking resembles *Telenassa teletusa*) . . . . . *selene* (p. 151)

***Eresia clara* Bates sp. rev.**

(Figs 177, 183, 184, 364–367)

[*Papilio nauplius* Linnaeus; Clerck, [1764]: pl. 46 [fig. 2]; Cramer, [1780]: 55, pl. 316, figs D–G. Misidentifications.]

[*Eresia clio* (Linnaeus); Doubleday, 1850: 184; Aurivillius, 1882: 172; Röber, 1913: pl. 92, row h [figs 1, 2]. Misidentifications.]

*Eresia clara* Bates, 1864b: 192. LECTOTYPE ♂, BRAZIL: Belem ('Para') (*H. W. Bates*) (BMNH, Type no. Rh. 8536; Gabriel, 1927: 32), here designated [examined].

[*Phyciodes clio* (Linnaeus); Kirby, 1871: 177; Röber, 1913: 446; Hall, 1929: 144. Misidentifications.]

*Phyciodes clio estebana* Hall, 1929: 146. Holotype ♂, VENEZUELA: San Esteban Valley, nr Puerto Cabello (ex *Hahnel*) (BMNH) [examined]. **Syn. n.**

*Phyciodes clio reducta* Hall, 1929: 146. Holotype ♂, ECUADOR: La Chima, Rio de las Juntas, pr. Bahahoyo, vi–vii. 1893 (*de Mathan*) (BMNH) [examined]. **Syn. n.**

[*Phyciodes (Eresia) clio* (Linnaeus); Forbes, 1945: 165–166, 189. Misidentification.]

♂ forewing 17–19 mm, upperside black, forewing with 4 well-defined white or yellowish spots; on hindwing upperside a white discal band of variable width; hindwing underside base narrowly white with broader white stripe below, above the white discal band. ♀ similar, usually slightly larger.

**Genitalia.** ♂, in dorsal view, tegumen wide, lateral shoulders well developed, posterior border of juxta gently convex, terminal bosses of scaphial extension small, spines not prominent; penis with large ostium-keel.

**DISTRIBUTION.** From S. Mexico through central and western South America to Peru and Bolivia, and in all the Amazon region, including the Guyanas, and southwards to western Mato Grosso.

**DISCUSSION.** External markings may be white or slightly yellowish; the extent of markings, especially that of the white transverse bar on the hindwing, may be slightly enlarged (*estebana*), or reduced in small specimens (*reducta*); the hindwing outer margin may be straight or gently convex. These variants appear to represent clinal phases with only minor taxonomic significance.

**NOMENCLATURE NOTE.** The name *Papilio clio* Linnaeus, used for this species by many authors, is based upon the figure by Merian (1705: pl. 35), and placed by Linnaeus in his group 'Heliconii', with *Papilio apollo*, etc. Merian's figure shows an Ithomiine, and was so recorded by Butler (1870: 126), possibly *Leucothyris aegle* (Fabricius) as later figured in 'Seitz' (pl. 38f). Confusion was introduced by Doubleday (1850: 184) when '*Papilio clio* L.(?)' was included in the list of species of *Eresia*, and again by Kirby (1871: 177) when he transferred *P. clio* L. to *Phyciodes* with the usual references, but now without the interrogation mark. Perhaps this incorrect identification led Aurivillius (1882) to introduce the name *clio* for the common *Phyciodes* species, as later accepted by Röber in 'Seitz', and by Hall. I imagine that Aurivillius never saw Merian's original figure, nor the paper by Bates (1864b), in which action was taken to give valid names to the two species figured as *nauplius* by Clerck and by Cramer.

*Papilio clio* was recorded by Linnaeus as a species represented in the collection of Queen Ludovica Ulrica, now preserved at Uppsala. I understand that there is no species in the collection today under this name, but there is a specimen of *Eresia clara* Bates under the name *P. nauplia* which corresponds in every way with the lower figure in Clerck ([1764]: pl. 46).

*Eresia nauplius* (Linnaeus) **comb. rev.**

(Figs 95, 96, 368–374)

*Papilio nauplius* Linnaeus, 1758: 488.*Eresia nauplia* (Linnaeus) Bates, 1864b: 192.

♂ forewing 20–22 mm, narrow, outer margin slightly concave; upperside grey-black with chalk-white markings like *E. clio* and additional small white submarginal mark in s3, s4; hindwing rather elongate, outer margin scalloped and fringes slightly chequered pale and dark; upperside with a broad white discal band extending from inner margin into s7; forewing underside grey with orange-brown and large white markings as on upperside; hindwing underside costa broadly white, divided by black-lined v8, followed by narrow brown and black stripes before the white discal band, then a white submarginal band divided into discrete lunules.

*Genitalia.* ♂, in dorsal view, variable, tegumen generally narrow, shoulders little developed (Fig. 369), lateral borders of scaphial extension straight or slightly divergent, terminal bosses well developed, rarely very large (Fig. 368) or otherwise modified (Fig. 370), posterior border of juxta prominent, penis slender, ostium-keel well developed. ♀ bursal duct chitinised, rather long, conical, bursal support cup-shaped, scutum well defined.

DISTRIBUTION. Brazil, the Guyanas.

Two subspecies, with similar genitalia.

*Eresia nauplius nauplius* (Linnaeus)

(Figs 95, 368–374)

*Papilio nauplius* Linnaeus, 1758: 488; Clerck, [1764]: pl. 46, fig. [1]. Syntype(s), [?SURINAM] ('In Indiis') (University of Uppsala).

*Papilio nauplia* Linnaeus; Linnaeus, 1767: 783; Aurivillius, 1882: 105.

[*Phyciodes clara* (Bates); Röber, 1913: 446, pl. 92, row h [fig. 5]. Misidentification.]

*Phyciodes nauplia nauplia* (Linnaeus); Hall, 1929: 147 [note: Hall's synonymy is in part erroneous]; Forbes, 1945: 165–6, 189.

Forewing underside cell-base orange-brown to round white cell-spot, with orange mark beyond; width of hindwing upperside white discal band about 3 mm.

DISTRIBUTION. Probably restricted to the Guyana shield, and Amazon region of Brazil.

*Eresia nauplius extensa* (Hall)

(Fig. 96)

*Phyciodes nauplia extensa* Hall, 1929: 148. Holotype ♂, BRAZIL: Chapada, Mato Grosso (*H. H. Smith*) (BMNH) [examined].

*Phyciodes* (*Eresia*) *nauplia extensa* Hall; Forbes, 1945: 166.

Like *E. nauplius nauplius*, but hindwing upperside white discal band about 4 mm wide; forewing underside cell-base white, sometimes fusing with round cell-spot; underside of both wings with white markings wider, more extensive.

DISTRIBUTION. Brazil: Mato Grosso (5 specimens), lower R. Madeira (1 specimen).

DISCUSSION. The six specimens in the BMNH show constant characters, and others in the Hall Coll. (BM, Brighton) are similar. Accepted by Prof. Keith Brown (pers. comm.) as a geographical subspecies, distributed from central Mato Grosso westwards.

*E. nauplius* has proved to be, taxonomically, the most difficult species of the genus. The external features appear to be well defined, but the male genitalia show marked variation in the shape of the dorsal structures and of the posterior border of the juxta, to an extent not seen in any other species. It may be that two or more species are present in the complex. Four figures of male genitalia are included to show the extent of variation found in a series of 14 preparations.

*Eresia plagiata* (Röber) comb. n., stat. n.

(Figs 97, 375–379)

*Phyciodes nauplia plagiata* Röber, 1913: 446; Hall, 1929: 148; Forbes, 1945: 166. ♀ syntype(s), PERU: upper Madre de Dios, 1500–3000 ft [500–1000 m] (*A. H. Fassi*) (depository unknown).  
 [*Eresia nauplia* (Linnaeus); Röber, 1913: pl. 92, row h [fig. 5]. Misidentification.]

♂ forewing 23–24 mm, like *E. nauplius*; upperside white markings slightly larger; hindwing outer margin not scalloped, fringes brown, white discal band about 3.5 mm wide, rarely invades *s7*; forewing underside with cell white, fusing with white cell-spot, brown mark beyond vestigial, if present; hindwing underside markings as in *E. nauplius*, brown postdiscal line and white submarginal line both continuous, not lunulate as in *E. nauplius*. ♀ slightly larger, underside marginal markings better defined.

*Genitalia*. ♂ in dorsal view, tegumen wide, lateral walls of scaphial extension divergent, strongly chitinized, terminal bosses large, posterior border of juxta curved; penis slender; only minor variation has been seen. ♀ like *E. nauplius*, bursal duct perhaps shorter and wider (single preparation).

DISTRIBUTION. Brazil (including Amazon regions, Iquitos, Teffe etc.), Colombia (Florida), Peru (R. Chuchurras, La Merced), Ecuador. Not seen from the Guyanas, or lower Amazon.

*Eresia letitia* Hewitson comb. rev.

(Figs 98, 99, 380–384)

*Eresia letitia* Hewitson, 1869a: 24 [index].

*Phyciodes letitia* (Hewitson); Röber, 1913: 448.

♂ forewing 24 mm, outer margin gently convex, upperside black, markings white or pale grey; hindwing transverse discal band white or yellowish, submarginal striae flat. ♀ ground-colour yellow-brown or white (form *leucophaea*), forewing 26 mm or more, markings as in ♂, often enlarged.

*Genitalia*. Variable, see below.

DISTRIBUTION. Colombia, Ecuador, Peru.

Two subspecies with similar genitalia.

*Eresia letitia letitia* Hewitson

(Figs 98, 382, 384)

*Eresia letitia* Hewitson, 1869a: 24 [index]; Hewitson, [1870]: [38], pl. [21], figs 70, 75, 76; Röber, 1913: pl. 91, row a [fig. 3]. LECTOTYPE ♀, ECUADOR: St. Inez, Buckley (BMNH, Type no. Rh. 8538; Gabriel, 1927: 73), here designated [examined].

? *Eresia leucophaea* Weymer, 1890: 54. ♀ syntypes, ECUADOR (? MNHU, Berlin).

*Phyciodes letitia letitia* (Hewitson); Hall, 1929: 149; Forbes, 1945: 165.

♂ upperside markings well defined, hindwing transverse white band 4 mm wide in specimens from Colombia, slightly narrower in those from Ecuador.

*Genitalia*. ♂ tegumen wide, lateral shoulders prominent in three examples from Colombia, scaphial extension wide in two specimens but narrower in a third specimen.

DISTRIBUTION. Colombia, Ecuador (hindwing upperside white discal band often narrower).

*Eresia letitia ocellata* (Röber) stat. rev.

(Figs 99, 380, 381, 383)

*Phyciodes letitia ocellata* Röber, 1913: 448. Syntype(s), PERU: Chanchamayo (depository unknown).

*Eresia neptoides* Rosenberg & Talbot, 1914: 675. Holotype ♂, PERU: El Porvenir, 900 m, April 1908 (BMNH) [examined].

*Eresia letitia nigra* Rosenberg & Talbot, 1914: 676. Holotype ♂, PERU: Huancabamba, Cerro del Pasco (BMNH) [examined]. Syn. n.

[*Phyciodes leucophaea* (Weymer); Röber, 1913: 448. Misidentification.]

[*Eresia leucophaea* Weymer; Röber, 1913: pl. 91, row a [fig. 4]. Misidentification.]

*Phyciodes letitia nigra* (Rosenberg & Talbot); Hall, 1929: 150; Forbes, 1945: 165.

*Phyciodes letitia nigra* f. *leucophaeoides* Hall, 1929: 151. Holotype ♀, PERU: Chanchamayo (BM, Brighton).

*Phyciodes ocellata* Röber; Hall, 1929: 151; Forbes, 1945: 165; 189.

♂ upperside darker, pale markings suffused with dark scales; hindwing upperside pale transverse band narrow, 2.5 mm, widest at centre, white or yellowish.

*Genitalia.* Of five preparations, the lateral shoulders of the tegumen are prominent in three, but in two examples they do not project laterally; scaphial extensions wide, or narrower and longer (Fig. 381).

**DISTRIBUTION.** Peru, in which it appears to be rather widely distributed. The nominate form has not been seen from this region.

**DISCUSSION.** Specimens with discal band yellowish on upperside of the hindwing are typical of *ocellata*, later named *neptoides* by Rosenberg & Talbot. In the *neptoides* type-series, seven specimens all from El Porvenir in Peru, the outer margin of the hindwing is straight.

### *Eresia lansdorfi* (Godart) **comb. rev.**

(Figs 100, 385)

*Heliconia lansdorfi* Godart, 1819: 209. Syntype(s), BRAZIL (depository unknown).

*Melinaea langsdorffii* (Godart) Hübner, [1821–1822]: pl. [68], figs 389, 390; 1823: 31.

*Heliconia langsdorffii* Godart; Godart, [1824]: 806.

*Phyciodes lansdorfi* (Godart) Staudinger, 1885: 92, pl. 36 (♂); Röber, 1913: 448; Hall, 1929: 154; Forbes, 1945: 162, 164, 189; Hayward, 1964b: 338, pl. 18, fig. 12.

*Eresia lansdorfi* (Godart) Röber, 1913: pl. 92, row a [figs 1, 2].

*Phyciodes lansdorfi* f. *jacinthica* Röber, 1913: 448, pl. 90, row k [fig. 6]. LECTOTYPE ♀, BRAZIL: San Jacintho, Theophilo Ottoni, Minas Geraês (*F. Birch*) (BMNH), here designated [examined].

*Phyciodes lansdorfi* f. *veternosa* Ferreira d'Almeida, 1922: 181. Holotype ♀, BRAZIL: Jacarépaguá (*Tanque*) (depository uncertain).

*Phyciodes lansdorfi* ♀ f. *sulphurata* Zikán, 1937: 386. Holotype ♀, BRAZIL: 'Südabhang des Itatiaya, 700 m., 27th December' (depository uncertain).

*Phyciodes lansdorfi* (Latreille); Hayward, 1952: 290.

♂ forewing upperside black, obscure basal stripe yellowish, post-discal area light red-brown, including costal bar; hindwing upperside black, transverse band pale yellow. ♀ variable, usually like ♂, but in some areas (form *jacinthica*) forewing upperside basal stripe well defined, light brown, and hindwing upperside submarginal lunules present in s1b–s4. More rarely upperside forewing red-brown markings more or less replaced by yellow (? f. *sulphurata*).

*Genitalia.* ♂ distinctive, tegumen wide, shoulders not defined, lateral walls of scaphial membrane chitinised, diverging, terminal bosses small, posterior border of wide juxta almost straight, harpes short, tapering. ♀ not examined.

**DISTRIBUTION.** Brazil (from Espirito Santo and Bahia southwards through Parana to Rio Grande do Sul), N. and C. Argentina, Paraguay, Uruguay (and Peru?).

### *Eresia sestia* Hewitson **comb. rev.**

(Figs 101, 102, 386, 387)

*Eresia sestia* Hewitson, 1869a: 26 [index]; Hewitson, [1870]: [37], pl. [21], figs 68, 69, 74; Fassl, 1912: 122.

LECTOTYPE ♂, ECUADOR: Jorge (*Buckley*) (BMNH, Type no. Rh. 8548; Gabriel, 1927: 109], here designated [examined].

*Phyciodes sestia* (Hewitson) Röber, 1913: 446, pl. 90, row g [fig. 9], row h [figs 1, 2].

*Phyciodes saturata* Röber, 1913: 446, pl. 90, row h [fig. 3] [valid name?—apparently proposed in synonymy of *P. sestia* (Hewitson)]. LECTOTYPE ♀, ECUADOR: 'Cachabé, low c., xi. 1896, ex *Rosenberg*' (BMNH), here designated [examined].

*Phyciodes sestia sestia* (Hewitson); Hall, 1930: 171; Forbes, 1945: 170.

*Phyciodes sestia sestia* ♀ f. *satura* Röber; Hall, 1930: 172; Forbes, 1945: 170.



♂ forewing 23–24 mm, upperside black with fulvous markings in a pattern very like *E. letitia* ♀, a curved longitudinal streak from wing-base to s2 prominent. ♀ wings broader, postdiscal markings white, discal markings as in ♂, cream-yellow or fulvous (f. *saturata*).

*Genitalia.* ♂, in dorsal view, tegumen shoulders not prominent, scaphial extension rather narrow but spiny terminal bosses well defined, posterior border of juxta prominent, saccus slender, harpe slender, almost straight. ♀ not examined.

DISTRIBUTION. Ecuador (also recorded from Colombia by Hall, 1929: 172).

*Eresia coela* Druce **comb. rev., stat. rev.**

(Figs 103, 104, 388, 389)

*Eresia coela* Druce, 1874b: 37; Godman & Salvin, 1882: 187, pl. 21, figs 2, 3; Schaus, 1913: 344, pl. 50, fig. 8; Röber, 1913: p. 91, row c [fig. 4]. LECTOTYPE ♀ (♂), COSTA RICA: Limon (BMNH, Type no. Rh. 8550, Gabriel; 1927: 33), here designated [examined].

*Phyciodes coela* (Druce) Röber, 1913: 444.

*Phyciodes sestia coela* (Druce); Hall, 1930: 172; Forbes, 1945: 170.

♂ forewing 22 mm, like *E. sestia*, upperside black, markings fulvous; hindwing upperside fulvous discal band wider, submarginal spots not prominent; hindwing underside discal band terminating before black marginal border, submarginal spots small, discrete and well defined. ♀ forewing 23–25 mm, broad, apex rounded, upperside black, markings white as in *E. sestia* but lacking basal coloured area; hindwing fulvous discal field larger, otherwise as in *E. sestia*.

*Genitalia.* ♂ tegumen wide, shoulders defined, scaphial extension narrow, spiny bosses not well formed, posterior border of juxta slightly prominent, saccus narrow, posterior section of valve slender, harpes slender, almost straight. ♀ with rami of the bursal support unusually large.

DISTRIBUTION. Costa Rica, coastal regions (Schaus).

NOTE. I have examined 5 ♀ in the BMNH, and 2 ♂ and 1 ♀ in the Hall Coll. (BM, Brighton).

*Eresia oblita* (Staudinger) **comb. rev., stat. rev.**

(Figs 105, 390)

*Phyciodes oblita* Staudinger, 1885: 93; Röber, 1913: 446. 1 ♂, 6 ♀ syntypes, VENEZUELA: Puerto Cabello (MNHU, Berlin).

*Eresia oblita* (Staudinger); Röber, 1913: pl. 92, row d [fig. 5].

*Phyciodes carme oblita* Staudinger; Hall, 1929: 141; Forbes, 1945: 164.

♂ forewing 21 mm, upperside dark brown, markings fulvous yellow, large spots in oblique row as in *E. polina*, additional spots in cell and a costal bar less prominent; hindwing upperside discal bar 4–5 mm wide at cell, tapering slightly to inner margin, narrow post-discal and *submarginal lunules well defined*; forewing underside markings similar, paler; hindwing underside markings like *E. polina* but submarginal band orange with black proximal border. ♀ similar, slightly larger.

*Genitalia.* ♂ tegumen in dorsal view rather narrow, shoulders not prominent, scaphial bosses large, spines numerous, posterior border of juxta gently convex. ♀ not examined.

DISTRIBUTION. Venezuela (San Esteban Valley) (Hall, 1929: 141 erroneously indicates Staudinger's material as coming from Colombia).

*Eresia carme* Doubleday **comb. rev.**

(Figs 106–108, 391–393)

*Eresia carme* Doubleday, [1847]: pl. 20.

*Phyciodes carme* (Doubleday) Staudinger, 1885: 93.

♂ forewing 20–23 mm, upperside dark brown, markings fulvous, large spots in s1b–s2, and in s4 in an oblique series; hindwing upperside discal band usually tapers sharply to inner margin, white or pale in

s1a-s1c; underside hindwing and forewing markings yellow-buff, usually gleaming. ♀ larger, forewing upperside with additional postdiscal costal mark, spots yellow, hindwing fulvous discal band wider.

*Genitalia.* See below.

**DISTRIBUTION.** Venezuela and Colombia.

Two subspecies, genitalia probably differ slightly.

*Eresia carme carme* Doubleday

(Figs 106, 107, 391, 392)

*Eresia carme* Doubleday, [1847]: pl. 20, fig. 5; [1848]: 183. LECTOTYPE ♀, VENEZUELA (BMNH, Type no. Rh. 8541; Gabriel, 1927: 26), here designated [examined].

*Phyciodes carme* (Doubleday); Staudinger, 1885: 93; Röber, 1913: 446.

*Phyciodes carme carme* (Doubleday); Hall, 1929: 140; Forbes, 1945: 164.

♂ forewing upperside fulvous markings scanty, post-discal spot in s1b quadrilateral, spot in s2 similar but displaced slightly distad, spot in s4 similar, spot in s5 and costal markings vestigial.

*Genitalia.* ♂, in dorsal view, tegumen wide, shoulders variable, scaphial extension short, terminal spines large but bosses not well defined, posterior border of juxta gently curved, saccus tapering; penis robust, ostium-keel small.

**DISTRIBUTION.** Venezuela, Colombia (?).

*Eresia carme laias* Godman & Salvin, **comb. rev.**

(Figs 108, 393)

*Eresia laias* Godman & Salvin, 1879: 151, pl. 14, fig. 1. LECTOTYPE ♂, COLOMBIA: Frontino, Antioquia (T. K. Salmon) (BMNH, Type no. Rh. 8542; Gabriel, 1927: 70), here designated [examined].

*Phyciodes laias* (Godman & Salvin) Röber, 1913: 446, pl. 90, row g [figs 7, 8].

*Phyciodes laias lycus* Hall, 1928a: 12; Hall, 1929: 144. Holotype ♂, COLOMBIA: Rio Aguaca Valley (BM, Brighton) [examined]. **Syn. n.**

*Phyciodes laias laias* (Godman & Salvin); Hall, 1929: 143.

*Phyciodes (Eresia) carme laias* (Godman & Salvin); Forbes, 1945: 164.

*Phyciodes (Eresia) carme lycus* Hall; Forbes, 1945: 164.

♂ like *carme carme* but forewing upperside markings differ slightly; fulvous postdiscal spots in s1b + s2 + s3 united to form an elongate macule, spot in s5 and small submarginal spots in s3 and s4 all well defined (3 specimens); markings may be extended by a cell-spot and a postdiscal costal spot, both well defined (form *lycus*). ♀ unknown.

*Genitalia.* ♂, in dorsal view, like *carme carme* but posterior section of valve very slender (*E. carme laias (lycus)*, single preparation).

**DISTRIBUTION.** W. Colombia.

**DISCUSSION.** *E. carme* is a rare species, not well represented in the BMNH. *E. laias* was described as an independent species, with *lycus* as a subspecies. I have followed Forbes and retained *laias* as a subspecies of *carme*, but it seems more likely that it simply represents a local form of minor taxonomic importance. The BMNH includes three specimens of *laias* and two specimens sufficiently well marked to be placed as f. *lycus*. The additional markings can often be seen, vaguely outlined, on normal ♀ specimens of *carme*. The underside wing-markings show close relationship to *E. polina* (included by Forbes as a subspecies of *carme*).

*Eresia polina* Hewitson **comb. rev., stat. rev.**

(Figs 109, 394, 395)

*Eresia polina* Hewitson, [1852]: [60], pl. [30], fig. 6. LECTOTYPE ♂, ECUADOR: 'Quito' (BMNH, Type no. Rh. 8540; Gabriel, 1927: 98), here designated [examined].

*Eresia encina* Felder & Felder, 1861: 103. LECTOTYPE ♂, ECUADOR (BMNH), here designated [examined]. [Specimen bears Felders' original determination label.]

*Phyciodes polina* f. *intermedia* Röber, 1913: 446, pl. 92, row g [fig. 5]. ♂ syntype(s), BOLIVIA (depository unknown).

*Phyciodes polina* (Hewitson) Staudinger, 1885: 93; Röber, 1913: 445; Hall, 1929: 142.

*Phyciodes* (*Eresia*) *carne polina* (Hewitson); Forbes, 1945: 164.

♂ forewing 27–28 mm, upperside black with 3 large yellow spots placed obliquely in s1b, s2 and s4, discoidal and costal markings vestigial; on hindwing a wide yellow transverse band tapering slightly to inner margin; underside forewing base fulvous, additional yellow spots at cell-end, on costa beyond cell and small apical markings; hindwing underside pale yellow, gleaming, veins brown, and basal, sub-basal, post-discal and submarginal stripes brown, the last proximally bordered black and wide. ♂ similar, yellow markings often enlarged.

*Genitalia.* ♂ organs large, in dorsal view tegumen strongly chitinised, scaphial extension short, terminal bosses large with prominent spines, juxta with posterior border gently curved, harpes slender, almost straight. ♀ not examined.

DISTRIBUTION. Colombia, Ecuador, Peru, Bolivia.

*Eresia alsina* Hewitson **comb. rev.**

(Figs 110, 111, 396–398)

*Eresia alsina* Hewitson, 1869b: 33; Hewitson, [1870]: [35], pl. [20], figs 62, 63; Godman & Salvin, 1882: 186; 1901: 671. LECTOTYPE ♀, NICARAGUA: Chontales (*T. Belt*) (BMNH, Type no. Rh. 8552; Gabriel, 1927: 10), here designated [examined].

*Phyciodes alsina* (Hewitson); Röber, 1913: 448, pl. 90, row k [fig. 5]; Hall, 1930: 174; Forbes, 1945: 169, 189.

[*Eresia heliconina* Röber; Röber, 1913: pl. 91, row a [fig. 2] (♂). Misidentification.]

[*Phyciodes* (*Eresia*) *eutropia* Hewitson; Young, 1973: 87. Misidentification.]

♂ forewing 25–26 mm, upperside orange-fulvous, wing margins black, 3 very oblique black bars, proximal bar narrow, tapering to a single line as it meets the outer margin, apical markings and marginal spots yellowish. ♀ larger, forewing 28–29 mm, wider, apex more rounded, markings similar.

*Genitalia.* ♂ like *E. eunice*, tegumen short, in dorsal view shoulders well defined, lateral walls of scaphial extension slightly divergent, terminal spiny bosses rounded, posterior border of juxta almost straight, saccus wide, tapering. ♀ like *E. eunice* (not figured).

DISTRIBUTION. Nicaragua, Costa Rica.

BIOLOGY. Young (1973) describes the early stages, host plant, mimicry and other aspects of the biology of what appears to be this butterfly, under the name *eutropia* Hewitson.

*Eresia cissia* (Hall) **comb. n., stat. n.**

(Figs 112, 399–401)

*Phyciodes ithomioides cissia* Hall, 1928a: 12; Hall, 1930: 181, pl. 2, fig. 5 (♂); Forbes, 1945: 169.

Holotype ♂, COLOMBIA: Juntas, Cauca Valley (*de Mathan*) (BMNH) [examined].

♂ forewing 25 mm, apex rounded, compared with *E. ithomioides* by Hall, but upperside ground-colour yellow, forewing markings more regular, basal area yellow, with black postdiscal costal bar followed by small yellow postdiscal and submarginal markings; hindwing base and discal area yellow, series of yellow submarginal spots regular, enclosed in wide black marginal band. ♀ not examined.

*Genitalia.* ♂ in dorsal view, tegumen short, shoulders prominent, terminal bosses with a few large spines but not really well defined, posterior border of juxta straight, saccus wide, tapering rapidly to pointed apex; penis as in Fig. 401.

DISTRIBUTION. Colombia (Cauca Valley, Juntas (2 ♂)).

*Eresia eutropia* Hewitson **comb. rev.**

(Figs 113, 114, 402)

*Eresia eutropia* Hewitson, 1874b: 56. LECTOTYPE ♂, PANAMA: Santa Fé (BMNH, Type no. Rh. 8553; Gabriel, 1927: 48), here designated [examined].

[*Phyciodes eutropia* (Hewitson); Godman & Salvin, 1882: 187, pl. 21, fig. 1; Röber, 1913: 447; Hall, 1930: 175; Forbes, 1945: 169–70, 189. Misidentifications: all referred to *E. melaina*.]

♂ forewing 22–24 mm, outer margin slightly excavate, upperside black, markings pale yellow or white, much of s1b and lower half of cell fulvous, but inner margin black, oblique discal band yellow or white, irregular, broken into spots by black veins, spot at base of s3 out of line, postdiscal band usually somewhat irregular, spot in s4 more or less divided, submarginal spots small; hindwing upperside fulvous, costa and outer margin black, series of submarginal spots complete from s1c–s7; underside markings enlarged, often confluent; hindwing costa black. ♀ forewing 27 mm, wide, apex rounded, outer margin convex, markings as in ♂, submarginal spots well developed, hindwing underside submarginal spots white.

*Genitalia.* ♂ tegumen rather wide in dorsal view, shoulders developed, lateral walls of scaphial extension slightly divergent, terminal bosses not well defined, spines large, posterior border of juxta prominent, saccus tapering. ♀ not examined.

DISTRIBUTION. Panama, W. Colombia.

NOTE. This species was incorrectly identified by Godman & Salvin, Röber, Hall and Forbes; their descriptions and figures refer to the new species described below under the name *melaina*.

*Eresia mimas* (Staudinger) **comb. n., stat. rev.**

(Figs 116, 174)

*Phyciodes mimas* Staudinger, 1885: 93; Röber, 1913: 448. ♂, ♀ syntypes, COLOMBIA: Rio San Juan (*E. Troetsch*) (? MNHU, Berlin; BM, Brighton) [♂ syntype in BM, Brighton, examined].

*Phyciodes alsina subfasciata* Röber, 1913: 448, pl. 92, row c [fig. 3] (as *mimas*). Syntype(s), COLOMBIA (depository unknown). **Syn. n.**

*Phyciodes eutropia subfasciata* Röber; Hall, 1930: 177; Forbes, 1945: 170.

*Phyciodes eutropia mimas* Staudinger; Hall, 1930: 178; Forbes, 1945: 170.

♂ forewing 26 mm, like *E. eutropia*, but differs on forewing upperside, postdiscal (subapical) band regular, crossed by v5 and v6, slightly curved and continued by enlarged submarginal spot in s3 (perhaps variable), black mark in mid-cell terminates abruptly at median vein, inner margin not black, pale submarginal spots vestigial or absent. ♀ not identified (Hall, 1930: 178, records 1 ♀ in BMNH).

*Genitalia.* Not examined.

DISTRIBUTION. W. Colombia (R. San Juan).

DISCUSSION. Röber appears to have been confused about the identity of *mimas*, of which the type-locality is not Rio Dagua as he states. His name *subfasciata* is accepted here for the figure on his pl. 92, row c [fig. 3], which shows nominate *mimas*. There is a single specimen in BMNH and two specimens in Hall Coll., all ex Staudinger, one of the latter recorded as a 'co-type' (Hall, 1930: 178), and all labelled Rio San Juan. The phenotype is easily recognisable, the markings constant, clearly related to *E. eutropia*, which also occurs in Colombia. No specimen is available for dissection.

*Eresia quintilla* Hewitson **comb. rev., stat. rev.**

(Figs 122, 403, 404)

*Eresia quintilla* Hewitson, [1872]: [30], pl. [15], fig. 83. LECTOTYPE ♀, ECUADOR (*Buckley*) (BMNH, Type no. Rh. 8554; Gabriel, 1927: 102), here designated [examined].

*Phyciodes quintilla* (Hewitson) Röber, 1913: 447, pl. 90, row i [fig. 2].

*Phyciodes eutropia quintilla* (Hewitson); Hall, 1930: 178; Forbes, 1945: 170.

♂ like *E. mimas* but forewing upperside discal and post-discal markings bright yellow, fused and expanded to enclose the short postdiscal costal mark at cell-end, subapical orange band absent and submarginal pale spots present, especially well defined at wing apex; hindwing underside with or without black basal shade in s7. ♀ similar, usually slightly larger.

*Genitalia* (single preparation). ♂ tegumen wide, tapering, shoulders well defined, scaphial extension lateral

walls not diverging, terminal bosses with large spines, posterior border of juxta gently convex, saccus tapering, harpes slightly sinuous (slide no. 2576). ♀ with usual generic characters, bursal support well defined.

DISTRIBUTION. Ecuador.

*Eresia poecilina* Bates comb. rev., stat. rev.

(Figs 115, 121)

*Eresia poecilina* Bates, 1866: 133; Godman & Salvin, 1882: 188, pl. 20, figs 19, 20 [lectotype].

LECTOTYPE ♀, PANAMA: Veragua, Santa Fé (*Arcé*) (BMNH, Type no. Rh. 8566; Gabriel, 1927: 98), here designated [examined].

*Phyciodes poecilina* (Bates) Röber, 1913: 448.

*Phyciodes ithomioides poecilina* (Bates); Hall, 1930: 181; Forbes, 1945: 169.

*Phyciodes eutropia confirmans* Hall, 1930: additional page. Holotype ♂, COSTA RICA (*A. G. M. Gillott*) (BMNH) [examined]. Syn. n.

♂ upperside black, markings white or yellowish, forewing 26 mm, a short red basal flush present, 3 pale spots in s2, basal and submarginal spots in s3, oval spot in cell, 2 spots in s4 (an additional basal spot may be present), 3 spots in s5, series of small submarginal spots complete from s1b-s8; hindwing upperside orange-red, costa and outer margin black, tapering to anal angle, with prominent white submarginal spots in s6 and s7; underside forewing spots similar, slightly larger. ♀ forewing wider, markings slightly larger but arrangement similar, hindwing submarginal white spots in complete series; hindwing underside often with disk flushed grey-blue (absent in lectotype).

*Genitalia*. Not examined.

DISTRIBUTION. Panama (Santa Fé, Chiriqui, Laguna River), Costa Rica.

DISCUSSION. The postdiscal spots grouped together in s1b + s2 and in s4 + s5 form a useful character. The area between the postdiscal costal bar and the apical submarginal spots is unmarked. I have examined 1 ♂, 3 ♀ in the BMNH, and 1 ♂, 1 ♀ in the Hall coll. (BM, Brighton). Both males and 3 ♀ show the blue-grey, slightly vitreous ('violaceous-grey') suffusion on the hindwing underside referred to by Hall in his description of *confirmans*; this does not appear in the ♀ lectotype of *poecilina*, although this looks identical in all other respects.

*Eresia melaina* sp. n.

(Figs 117, 118)

[*Eresia eutropia* Hewitson; Godman & Salvin, 1882: 187, pl. 21, fig. 1 (♂); Röber, 1913: pl. 92, row b [fig. 5] (♂). Misidentifications.]

[*Eresia dimorphina* Butler; Godman & Salvin, 1882: 187, pl. 20, figs 17, 18 (♀). Misidentification.]

[*Phyciodes eutropia* (Hewitson); Röber, 1913: 447. Misidentification.]

[*Phyciodes eutropia eutropia* (Hewitson); Hall, 1930: 176; Forbes, 1945: 170. Misidentifications.]

*Phyciodes eutropia eutropia* ab. *nivifera* Hall, 1930: 177. Syntypes 4 ♀, PANAMA, COLOMBIA (BMNH) [examined].

♂ forewing 25-26 mm, upperside black, with scanty yellowish markings, a fulvous flush below cell in s1b, pale mark near cell-end usually elongate, followed by a small spot at base of s3, post-discal spots in s2 and s4 prominent, isolated, forming a useful specific character, postdiscal bar from costa to s4, submarginal spots small, often indistinct but series usually complete from s1b-s8; hindwing upperside fulvous, costa black, continued narrowly along outer margin, enclosing white spots in s6 and s7; underside markings similar. ♀ similar, upperside markings yellowish or white, slightly enlarged; forewing base of cell and much of s2 fulvous but base of s3 black; hindwing black marginal border wider, series of submarginal spots complete, a faintly yellow flush often present internal to marginal border in s5.

*Genitalia*. Not examined.

Holotype ♂, Panama: Veraguas (*Arcé*), ex Godman & Salvin Coll. (BMNH).

Paratypes. Panama: 1 ♀, same data as holotype; 2 ♀, Santa Fé (*Arcé*); 2 ♀, Lion Hill (*McLeannan*) (BMNH). Colombia: 1 ♀ (BMNH).

DISTRIBUTION. Panama (Veragua, El Valle, Santa Fé), Colombia.

NOTE. No male specimen is available for dissection. The ♂ figured by Godman & Salvin and erroneously named *eutropia* was accepted as 'type' by Röber and later by Hall, which has led, for many years, to confusion in identification of these species. This specimen is now fixed as the holotype of *melaina*.

*Eresia sticta* Schaus comb. rev., stat. rev.

(Figs 119, 405)

*Eresia sticta* Schaus, 1913: 344, pl. 50, fig. 7. ♂, ♀ syntypes, COSTA RICA (? BMNH) [identity of these types not confirmed].

[*Eresia coela* Druce; Röber, 1913: pl. 91, row c [fig. 5] (♀). Misidentification.]

*Phyciodes sticta* (Schaus) Röber, 1924: 1030, pl. 192, row h [fig. 4] (♂).

*Phyciodes ithomioides sticta* (Schaus); Hall, 1930: 181; Forbes, 1945: 169.

♂ forewing 26–27 mm, narrow, apex elongate, slightly truncate, upperside black with white markings consisting of small spots; a prominent spot over discoidal vein and many spots in postdiscal and submarginal areas; hindwing upperside orange-red, costa and inner margin broadly black, margin tapering in anal angle; underside similar, but hindwing black borders extended and series of white submarginal spots complete. ♀(?) larger, forewing 30 mm, wide, apex rounded.

*Genitalia*. ♂ tegumen short, wide, scaphial bosses not well defined, posterior border of juxta gently curved (slide no. 1023).

DISTRIBUTION. Costa Rica, ? Colombia (Hall, 1930: 182).

DISCUSSION. In my opinion, the ♀-form attributed to this species by Hall may be incorrectly placed. The species seems to be rare; 2 ♂ in BMNH, 1 ♂ in Hall Coll. (BM, Brighton). The fate and identity of Schaus' original syntypes are uncertain; a pair from Carillo in the BMNH, collected in February (the female certainly by Schaus) may represent the original material, described from specimens in the BMNH.

*Eresia ithomioides* Hewitson comb. rev.

(Figs 120, 124, 124a, 406, 407)

*Eresia ithomioides* Hewitson, [1864]: [18].

*Phyciodes ithomoides* [sic] (Hewitson) Röber, 1913: 448.

♂ forewing 28–29 mm, narrow, apex rounded, outer margin straight, markings consisting of white or yellow spots in discal and postdiscal areas; hindwing oval, disc fulvous, black outer margin enclosing pale submarginal spots; hindwing underside with black basal mark in s7, black marginal border extended along v7. ♀ differs, larger, forewing 36 mm, broad, apex rounded; upperside markings as in ♂ but spots larger; hindwing upperside orange-fulvous, submarginal spots obscure in wider dark border; underside black borders wide, series of submarginal spots prominent and complete (described from single specimen in BMNH).

*Genitalia*. ♂ organs wide, tegumen short, in dorsal view scaphial bosses not well defined, posterior border of juxta wide, gently convex, base of saccus wide; penis in side view slender, ostium-keel prominent.

DISTRIBUTION. Colombia, ? Panama.

Two subspecies.

*Eresia ithomioides ithomioides* Hewitson

(Figs 120, 124a)

*Eresia ithomioides* Hewitson, [1864]: [18], pl. [9], fig. 20. LECTOTYPE ♂, COLOMBIA: 'New Granada',

Bogotá (*E. Birchell*) (BMNH, Type no. Rh. 8565; Gabriel, 1927: 66), here designated [examined].

*Phyciodes ithomoides* [sic!] (Hewitson); Röber, 1913: 448, pl. 90, row k [fig. 2].

*Phyciodes ithomioides ithomioides* (Hewitson); Hall, 1930: 179; Forbes, 1945: 169.

♂ upperside forewing base black; hindwing fulvous discal area reduced by extension of black marginal border, rarely entirely black.

DISTRIBUTION. Colombia.

*Eresia ithomioides pseudocelemina* (Strand) **stat. n.**

(Fig. 124)

*Phyciodes pseudocelemina* Strand, 1916: 6, pl. 16, fig. 13. Holotype ♂, COLOMBIA (BMNH) [examined].

*Phyciodes ithomioides ithomioides* ♂ f. *pseudocelemina* Strand; Hall, 1930: 180.

♂ differs from nominate form: forewing upperside base and discoidal cell bright fulvous; hindwing fulvous area extending to black marginal border, black extension along v7 variable, sometimes vestigial; hindwing underside black mark in s7 reduced.

DISTRIBUTION. Colombia (Magdalena Valley, May (*C. Allen*); 5 ♂ in BMNH).

DISCUSSION. The BMNH has two males of the nominate form, and five males of *pseudocelemina*, all from Colombia, and it may be that they represent a simple cline, but with so little material it is not possible to be sure of the best taxonomic rank. There is a single ♂ in the Hall Coll. (BM, Brighton).

The *Eresia* species *poecilina*, *sticta*, *ithomioides* and *melania* form a difficult group. It is especially difficult to assemble the females with the appropriate male. The arrangement adopted here may need revision when more material is available. The species are all rare, poorly represented in collections, most often by single specimens taken at long intervals by different collectors, in various localities. I have accepted the precise arrangement of spots on the upperside of the forewing as the most reliable character for definition of species and for association of sexes. It seems possible that one or more of the females may be polymorphic, but I have had to describe as a distinct species (*anomala*) one well-known but previously unnamed ♀ form, for which I have not been able to identify a male.

*Eresia anomala* **sp. n.**

(Fig. 123)

[*Phyciodes ithomioides* (Hewitson); Röber, 1913: 447, pl. 90, row k [figs 3, 4] (♀, as *Eresia* on pl.).

Misidentification.]

[*Phyciodes ithomioides ithomioides* (Hewitson); Hall, 1930: 180 (♀ only). Misidentification.]

♀ forewing 30 mm, upperside dark grey-brown, markings yellowish spots arranged as in *E. poecilina* but spot at base of s2 constantly absent, postdiscal spot in s2 well separated from submarginal spot; hindwing upperside dark grey-brown, series of submarginal spots yellowish, large, complete, a slightly variable fulvous flush extending along inner margin and across s2, a postdiscal series of yellow, rectangular marks present in s2-s5. All markings similar on underside.

Holotype ♀, Colombia: Muzo, 1924 (*Apollinar Maria*) (ex Joicey Coll.) (BMNH).

Paratypes. Colombia: 4 ♀, (no further data); 3 ♀, Bogata; 2 ♀, Valdevia, 1897 (*Pratt*) (BMNH); 3 ♀, 'Colombia' (BM, Brighton).

There is little variation in the series of ten specimens in the BMNH and three specimens in the Hall Coll. (BM, Brighton). Compared with other species in this section, *E. anomala* appears to be relatively common. It was attributed to *ithomioides* by Röber, but the absence on the forewing of the spot at base of s2 makes this attribution doubtful.

*Eresia nigripennis* Salvin **comb. rev., stat. rev.**

(Figs 125, 125a, 408)

*Eresia nigripennis* Salvin, 1869: 170; Godman & Salvin, 1882: 186, pl. 20, figs 15, 16. LECTOTYPE ♂, COSTA RICA: Cache (*Carmiol*) (BMNH, BM Type no. Rh. 8563; Gabriel, 1927: 86), here designated [examined].

*Eresia dimorphina* Butler, 1872: 78; Butler, 1874: 182, pl. 63, fig. 1 (♀). LECTOTYPE ♀, COSTA RICA: (van Patten) (BMNH; BM Type no. Rh. 8564), here designated [examined].  
*Phyciodes nigripennis* (Salvin) Röber, 1913: 447, pl. 90, row i [fig. 4] (♂); Hall, 1929: 169.  
*Phyciodes (Eresia) phillyra nigripennis* (Salvin); Forbes, 1945: 168.

♂ forewing 26–27 mm, elongate, apex truncate, outer margin excavate; upperside black with rather small postdiscal and submarginal white or yellowish spots; hindwing orange-red, costal and marginal borders black, enclosing pale submarginal spots in s7 and s8; ♀ larger, forewing 30–31 mm, wider, less abruptly truncate, pale markings usually yellowish, fulvous basal stripe indistinct; hindwing as in ♂.

*Genitalia*. ♂ like *E. phillyra*, shoulders of tegumen not greatly developed, posterior border of juxta curved, saccus rather slender (slide no. 896). ♀ not examined.

DISTRIBUTION. Restricted to Costa Rica.

*Eresia emerantia* Hewitson comb. rev.

(Figs 126, 127, 409, 410)

*Eresia emerantia* Hewitson, [1857]: [43], pl. [22], figs 7, 11; Röber, 1913: pl. 92, row d [fig. 6] (♂). LECTOTYPE ♂, COLOMBIA: 'New Grenada' (BMNH, Type no. Rh. 8551; Gabriel, 1927: 45), here designated [examined].

*Eresia emerantia* [sic!] Hewitson; Hewitson, [1864]: pl., fig. 14 (♂).

*Phyciodes emerantia* (Hewitson); Röber, 1913: 446.

*Phyciodes celemina* Röber, 1913: 448, pl. 90, row k [fig. 1] (♀). LECTOTYPE ♀, COLOMBIA: Cundinamarca, vii. 1903 (*de Mathau*) (BMNH), here designated [examined].

*Phyciodes emerantia* [sic!] (Hewitson); Hall, 1930: 173; Forbes, 1945: 170, 189.

♂ forewing 25 mm, upperside fulvous, black margins wide, apex black, enclosing 3 white subapical spots; hindwing underside yellowish, marginal spots pale yellow, large. ♀ differs: forewing wider, postdiscal area black with irregular white spots, submarginal spots white, series complete on both wings, resembling *E. ithomioides pseudocelemina* ♂.

*Genitalia*. ♂ in dorsal view elongate, shoulders of tegumen not conspicuous, inferior lamina of scaphial membrane well developed, spiny bosses defined, posterior border of juxta prominent, falces relatively very slender (slide no. 2740). ♀ with usual generic characters, rami of bursal support long.

DISTRIBUTION. Colombia.

*Eresia moesta* Salvin & Godman comb. rev.

(Figs 173, 411, 412)

*Eresia moesta* Salvin & Godman, 1868: 145. LECTOTYPE ♀, ECUADOR: Canelos (*Pearce*) (BMNH, Type no. Rh. 8577; Gabriel, 1927: 82), here designated [examined].

*Eresia ildica* Hewitson, 1869a: 24 [index]; Hewitson, [1872]: [30], pl. [15], fig. 84 (♀). LECTOTYPE ♀, ECUADOR: Aguano (*Buckley*) (BMNH, Type no. Rh. 8578; Gabriel, 1927: 62), here designated [examined].

*Eresia cerquita* Dognin, 1894: 680. LECTOTYPE ♂, ECUADOR: environs de Loja (BMNH), here designated [examined]. [Specimen bears Dognin's m/s type label.]

*Eresia (Phyciodes) ildica* var. *heliciformis* Strand, 1912a: 143. Holotype, ECUADOR: Macas ('Niepelt Coll. '; MNHU, Berlin ?).

*Phyciodes ildica fassli* Röber, 1913: 447, pl. 90, row i [figs 5, 6]. ♂, ♀ syntypes, COLOMBIA: Upper Rio Negro, 2500 ft [830 m] (*A. H. Fassli*) (Rothschild Coll., BMNH; Hall, 1930: 189; not found, but one ♂ from Bogota, ex Rothschild, is labelled 'Phyciodes fassli Rüb./Type' in Röber's handwriting). *Syn. n.*

*Phyciodes moesta moesta* (Salvin & Godman); Hall, 1930: 187; Forbes, 1945: 170.

*Phyciodes moesta moesta* f. *cerquita* (Dognin); Hall, 1930: 188; Forbes, 1945: 171.

*Phyciodes moesta moesta* f. *ildica* (Hewitson); Hall, 1930, 1930: 188, Forbes, 1945: 171.

*Phyciodes moesta fassli* Röber; Hall, 1930: 188; Forbes, 1945: 170.

♂ forewing 27–28 mm, upperside grey or rarely with slight reddish basal flush, more or less translucent, costa and outer margin rather broadly black, otherwise unmarked; hindwing usually similar, occasionally with red discal flush, costa and outer margin black, white submarginal spots usually present. ♀ similar, slightly larger.



The following colour forms have been named: 1, inner margin of hindwing red, f. *cerquita*; 2, forewing base and discal field of hindwing brick-red, f. *ildica*; 3, hindwing inner margin red, shading to yellow over disc, f. *fassli*.

*Genitalia*. ♂ organs large, tegumen short, shoulders not well developed, scaphial extension short, terminal bosses well defined with large spines, saccus base wide, tapering rapidly; penis with usual generic characters (slide no. 2793).

DISTRIBUTION. S. Colombia, Ecuador, Peru.

*Eresia phaedima* Salvin & Godman **comb. rev.**

(Figs 128, 413)

*Eresia phaedima* Salvin & Godman, 1868: 146. LECTOTYPE ♂, PERU: POZZUZO (*Pearce*) (BMNH, Type no. Rh. 8579; Gabriel, 1927: 97; genitalia slide no. 639), here designated [examined].

*Eresia prisca* Hopffer, 1874: 349; Röber, 1913: pl. 92, row e [fig. 1] (♂). ♂ syntypes, 'MEXICO'; PERU: Chanchamayo (*Thamm*) (MNHU, Berlin).

*Phyciodes prisca* (Hopffer); Röber, 1913: 447.

*Melitaea* (*Phyciodes*) *magniplaga* Röber, 1927: 98, fig. LECTOTYPE ♂, COLOMBIA: Canungucho, iii.-vi. 1926 (BMNH), here designated, [examined]. **Syn. n.**

*Phyciodes phaedima* (Salvin & Godman) Hall, 1930: 185; Forbes, 1945: 169, 189.

*Phyciodes magniplaga* (Röber) Hall, 1930: 186; Forbes, 1945: 170, 189.

♂ forewing 29–30 mm, like *moesta*, costa and outer margin black, base with fulvous extending along s1b to outer margin, short, oblique black band across cell, cell apex and postdiscal area translucent except postdiscal black band from costa to v4; hindwing like *moesta* but disc fulvous-brown, costa and outer margin broadly black, white submarginal spots prominent, apex of s6 usually yellow. ♀ similar, larger.

A single colour form has been named: upperside pale areas yellow, not fulvous-brown, f. *magniplaga*.

*Genitalia*. ♂ organs wide, tegumen narrow, scaphial extension longer than that of *moesta*, saccus rather narrow, elongate. ♀ not examined.

DISTRIBUTION. Peru, Colombia. According to Hall (1930: 186), Hopffer's record for Mexico is erroneous.

*Eresia datis* Hewitson **comb. rev.**

(Figs 129, 414)

*Eresia datis* Hewitson, [1864]: [17].

*Phyciodes datis* (Hewitson) Hall, 1930: 182.

♂ forewing 29–30 mm, upperside black, a broad discal band cream-white, a short basal streak below cell and field of hindwing brown or orange-brown; hindwing black marginal border rather wide, enclosing white submarginal dots, more distinct on underside. ♀ unknown.

DISTRIBUTION. Peru, Bolivia.

Two subspecies.

*Eresia datis datis* Hewitson

(Fig. 129)

*Eresia datis* Hewitson, [1864]: [17], pl. [9], fig. 14. LECTOTYPE ♂ [UPPER AMAZON—see Hall, 1930: 183] (BMNH, Type no. Rh. 8575, Gabriel, 1927: 38), here designated [examined].

? *Phyciodes fenestrata* Röber, 1914: 450, pl. 91, row c, fig. 3. Lectotype ♂, PERU: Huayabamba, SE. of Chachapoyas, 3500 ft [1300 m] (*O. T. Baron*) (BMNH) [examined]. [Specimen bears Röbers M/S determination labels.]

*Phyciodes datis datis* (Hewitson); Hall, 1930: 182; Forbes, 1945: 169, 189.

? *Phyciodes datis fenestrata* Röber; Hall, 1930: 183; Forbes, 1945: 169.

? *Phyciodes fenestrata derivata* Bryk, 1953: 92. Holotype ♀, PERU: Roque (NR, Stockholm).

♂ upperside basal streak of forewing and field of hindwing orange-brown.

*Genitalia*. ♂, in dorsal view, like *clara*, tegumen with a curious small central hiatus in two specimens examined, shoulders defined, scaphial extension with moderately divergent lateral walls, posterior border of juxta with small central prominence, saccus linguulate (slide no. 623).

DISTRIBUTION. 'Upper Amazon' (lectotype), Peru.

*Eresia datis corybassa* Hewitson

(Fig. 414)

*Eresia corybassa* Hewitson, 1874a: 6. LECTOTYPE ♂, BOLIVIA (*Buckley*) (BMNH, Type no. Rh. 8574; Gabriel, 1927: 35), here designated [examined].

*Phyciodes cornelia* Staudinger in litt.; Röber, 1914: 450, pl. 92, row g [fig. 1] (as *Eresia*). [Invalid: proposed in synonymy with *corybassa*.]

*Phyciodes datis corybassa* (Hewitson); Hall, 1929: 184; Forbes, 1945: 169.

? *Phyciodes corybassa mimicry* Bryk, 1953: 91. Holotype ♂, PERU: Roque (NR, Stockholm).

Like *E. datis datis*, but ♂ upperside basal streak of forewing and field of hindwing dark mahogany brown. ♀ similar, but larger.

*Genitalia*. Like *E. datis datis*, lateral walls of scaphial extension more divergent (single preparation).

DISTRIBUTION. S. Peru, Bolivia.

*Eresia margaretha* Hewitson comb. rev.

(Figs 130, 415)

*Eresia margaretha* Hewitson, [1872]: [29], pl. [15], fig. 77. LECTOTYPE ♂, COLOMBIA: Bogota ('New Granada') (*Chesterton*) (BMNH, Type no. Rh. 8576; Gabriel, 1927: 78), here designated [examined].

*Phyciodes margaretha* (Hewitson) Röber, 1914: 450, pl. 91, row b [fig. 1] (as *Eresia*).

*Phyciodes margaretha manto* Hall, 1930: 185. Holotype ♂, COLOMBIA: Rio Dagua (BMNH) [examined].

Syn. n.

*Phyciodes margaretha margaretha* (Hewitson); Hall, 1930: 184; Forbes, 1945: 169.

*Phyciodes (Eresia) margaretha manto* Hall; Forbes, 1945: 169.

♂ forewing 25 mm, upperside black, discal band and subapical spots yellow; basal streak and discal field of hindwing brick-red. ♀ unknown.

*Genitalia*. ♂, in dorsal view, organs wide, tegumen wide, scaphial extension and terminal spiny bosses well defined, posterior border of juxta almost straight, saccus wide, tapering rapidly to a pointed apex (slide no. 2718).

DISTRIBUTION. Colombia.

*Eresia eunice* (Hübner) comb. rev.

(Figs 131, 132, 135, 416–420)

*Nereis fulva eunice* Hübner, [1807]: pl. 9.

*Eresia eunice* (Hübner) Hewitson, [1857]: [44].

♂ forewing 22–25 mm, upperside base fulvous, distally paler, yellowish, markings black, a short stripe on median vein, a wide oblique band across end of cell which terminates abruptly in s3, but continues narrowly along v3 to blend with black outer margin, apex black, sometimes with traces of yellowish markings; hindwings similar, yellowish anterior to the wide black subcentral transverse band, submarginal area usually darker fulvous, subcostal stripe and outer margin black. ♀ similar, often slightly larger.

*Genitalia*. ♂ tegumen wide, tapering to well-formed shoulders, lateral walls of scaphial extension divergent, terminal bosses well defined with small spines, posterior border of juxta convex, valve apex slender, penis apex slender, ostium-keel prominent. ♀ bursal duct chitinised, short, bursal support globular, supporting rami short.

DISTRIBUTION. Brazil, the Guyanas, Panama, Venezuela, Colombia, Bolivia, Peru, Ecuador.

DISCUSSION. Three subspecies (or major colour phenotypes) are described below. It is difficult

to define these forms on a geographical basis although one or other of them may preponderate in a given area. Hall (1929: 157) states that nominate *eunice* is almost constant in Guyana and W. Brazil if the form *pella* is excluded. Intermediates between the several forms are very common and in some districts, according to Hall, two or more may fly together.

*Eresia eunice eunice* (Hübner)

(Figs 131, 418–420)

*Nereis fulva eunice* Hübner, [1807]: pl. 9, 4 figs. Syntype(s) ♂, ♀, [SOUTH AMERICA] (depository unknown).  
*Eresia pella* Hewitson, [1852]: [59], pl. [30], fig. 2. Syntypes, [BRAZIL] ('Amazon'): W. W. Saunders & W. C. Hewitson Colls (not in BMNH, probably in UM, Oxford).  
*Eresia eunice* (Hübner) Hewitson, [1857]: [44]; Bates, 1864b: 191.  
 [Eresia olivencia Bates; Röber, 1913: pl. 92, row b [fig. 1] (♀). Misidentification.]  
*Phyciodes eunice eunice* (Hübner); Hall, 1929: 156; Forbes, 1945: 167, 171.

♂ upperside fulvous, distal areas slightly paler in tone; hindwing yellow transverse discal band with black band posteriorly, followed by fulvous area. ♀ similar, often showing greater colour contrast, on forewing distal pale areas may be yellow.

*Genitalia.* As described above.

DISTRIBUTION. Brazil (including Lower Amazon), the Guyanas, Colombia, Peru, Ecuador.

*Eresia eunice olivencia* Bates

(Fig. 132)

*Eresia eunice* var. *olivencia* Bates, 1864b: 191. LECTOTYPE ♂, BRAZIL: São Paulo de Olivença (H. W. Bates) (BMNH, Type no. Rh. 8555; Gabriel, 1927: 89), here designated [examined].  
*Eresia drypetis* Godman & Salvin, 1878: 269; Godman & Salvin, 1882: 184, pl. 20, figs 11, 12. Holotype ♂, PANAMA: Lion Hill (*McLeannan*) (BMNH, Type no. Rh. 8556; Gabriel, 1927: 43) [examined]. **Syn. n.**  
*Phyciodes olivencia* (Bates) Staudinger, 1885: 193.  
*Ecesia* [sic!] *klagesii* Weeks, 1906: 195. Syntypes, VENEZUELA: Suapure (? MCZ, Cambridge).  
*Eresia klagesii* Weeks; Weeks, 1911: 1, pl. 1 (? ♂).  
*Phyciodes olivencia* f. *gudruna* Röber, 1913: 447, pl. 92, row b [fig. 2] (as *Eresia*). Syntype(s), 'Upper Amazon' (depository unknown).  
*Phyciodes olivencia* f. *brunhilda* Röber, 1913: 447, pl. 92, row b [fig. 3] (as *Eresia*). Syntype(s), 'Upper Amazon' (depository unknown).  
*Phyciodes olivencia polymnia* Röber, 1913: 447. ♂, ♀ syntypes, COLOMBIA: Medina, 1600 ft [530 m] (*Fassl*) (depository unknown).  
*Phyciodes eunice eunice* f. *olivencia* (Bates); Hall, 1929: 157.  
*Phyciodes eunice eunice* f. *klagesii* (Weeks); Hall, 1929: 158.  
*Phyciodes eunice eunice* f. *brunhilda* Röber; Hall, 1929: 158.  
*Phyciodes eunice drypetis* (Godman & Salvin); Hall, 1929: 158; Forbes, 1945: 167, 171.  
*Phyciodes (Eresia) eunice brunhilda* Röber; Forbes, 1945: 166.  
*Phyciodes (Eresia) eunice olivencia* (Bates); Forbes, 1945: 167.  
*Phyciodes (Eresia) eunice gudruna* Röber; Forbes, 1945: 167.  
 ? *Phyciodes eunice homogena* Bryk, 1953: 89–90. ♂, ♀ syntypes, BRAZIL: Amazonas, Taracua (NR, Stockholm).

♂ Upperside orange-brown, variable, black markings often reduced, pale areas prominent but without colour-contrast. Several named phenotypes, as noted in synonymy above. ♀ similar.

DISTRIBUTION. Brazil (locally), Venezuela, Guatemala, Colombia, Peru, Panama.

*Eresia eunice esora* Hewitson

(Figs 135, 417)

*Eresia esora* Hewitson, [1857]: [44], pl. [22], fig. 12. LECTOTYPE ♂, BRAZIL: [Espírito Santo] (BMNH, Type no. Rh. 8558; Gabriel, 1927: 47), here designated [examined].  
*Phyciodes esora* (Hewitson) Röber, 1913: 446.

[*Eresia eunice* (Hübner); Röber, 1913: pl. 92, row a [fig. 3] (♀). Misidentification.]

*Phyciodes eunice esora* (Hewitson); Hall, 1929: 158; Forbes, 1945: 167, 171; Hayward, 1964b: 340, pl. 18, fig. 13.

? *Phyciodes eunice* ♀ f. *albella* Zikán, 1937: 385. Holotype ♀, BRAZIL: [Fazenda] 'Jerusalem', Alegre, Espirito Santo, May (? Rio de Janeiro).

♂ forewing 22–23 mm, upperside apex solid black, oblique black costal bar wide, tapering, pale discal and postdiscal markings yellow, with marked colour-contrast; hindwing upperside yellow anterior to the black transverse band, ♂ genitalia examined, slide no. 2717. ♀ similar, usually larger.

DISTRIBUTION. Brazil (constant from Pernambuco, Bahia and Mato Grosso southwards; northern and north-western populations are more variable but remain distinct from *eunice eunice*), Ecuador, Paraguay, NE. Argentina.

DISCUSSION. Of all the modifications of this variable species, *esora* most nearly shows the characters and distribution of a true geographical race.

*Eresia etesia* (Hall) comb. n., stat. n.

(Figs 133, 134, 421)

*Phyciodes erysice etesia* Hall, 1929: 160, pl. 1, figs 8, 9. Holotype ♂, FRENCH GUIANA: 'Cayenne' (BMNH) [examined].

*Phyciodes (Eresia) erysice etesia* Hall; Forbes, 1945: 168.

♂ like *E. eunice*, forewing 25–26 mm, base fulvous, including most of cell and base of s<sub>2</sub>, oblique mark in mid-cell and irregular discal bar black, the last followed by yellow postdiscal band heavily suffused black, round yellow spots in s<sub>2</sub> and in s<sub>4</sub> rather prominent; hindwing upperside fulvous, costa and postdiscal band black, narrow submarginal lunules present from sic–s<sub>8</sub>; forewing underside markings expanded, pale yellow.

*Genitalia*. ♂ tegumen like *eunice*, slightly wider, posterior border of juxta gently convex, valve apex more robust, penis more massive, slightly sinuous (slide no. 1026). ♀ not examined.

DISTRIBUTION. French Guiana, N. Brazil.

*Eresia erysice* (Geyer) comb. n.

(Fig. 136)

*Melinaea erysice* Geyer, 1832: 28, figs 717, 718. Syntype(s), 'SOUTH AMERICA' (depository unknown) [For date and authorship see Hemming, 1937(1): 478.]

*Phyciodes erysice* Hübner; Kirby, 1871: 176.

*Phyciodes erysice erysice* Geyer; Hall, 1929: 160

*Phyciodes (Eresia) erysice erysice* (Hübner); Forbes, 1945: 168, 189.

♂ forewing 27 mm, upperside like *E. etesia*, forewing black discal band irregular but complete from costa to outer margin at v<sub>2</sub>, followed by well-developed, regular yellow oblique band, pale postdiscal spots in s<sub>2</sub> and s<sub>4</sub> absent (prominent in *etesiae*). Hindwing upperside transverse fulvous band broadly suffused with yellow; underside markings similar, hindwing underside submarginal spots white, series complete. ♀ larger, wings more rounded, pattern paler and more diffuse.

*Genitalia*. Not available for dissection.

DISTRIBUTION. Brazil, restricted to dense forest in Bahia, very rare and local (K. Brown, pers. comm.).

NOTE. The original figures 717, 718 were published by Hübner in [1826], but the name was published by Geyer in 1832, who also indicates that the original material was in the Franck Collection (Strasbourg). Hübner's anonymous catalogue of the Franck Collection ([Hübner], [1825]) does not list the species by name, but it may have been included by him as one of the un-named entries; it is possible that Hübner made his figures of the insect during his visit to Strasbourg.

*Eresia casiphia* Hewitson comb. rev.

(Figs 137, 138, 422)

*Eresia casiphia* Hewitson, 1869a: 25, [index]; Hewitson, [1870]: [38], pl. [21], figs 72, 73. LECTOTYPE ♂, ECUADOR: Jorge (*Buckley*) (BMNH, Type no. Rh. 8561; Gabriel, 1927: 27), here designated [examined].  
*Phyciodes casiphia* (Hewitson) Röber, 1913: 446; Hall, 1929: 166, pl. 1, fig. 7 (♀).  
*Phyciodes (Eresia) casiphia* (Hewitson); Forbes, 1945: 167, 189.

♂ upperside fulvous, markings black; forewing 23 mm, apex and wing-margins black, proximal oblique bar wide at costa, tapering to anal angle, distal oblique bar shorter, wider, fusing with outer margin, yellowish preapical bar present but rather obscure; hindwing post-discal transverse bar complete, fusing with marginal black border, a small white spot at *s*7 enclosed within the border. ♀ similar, forewing 27 mm, wider, upperside postdiscal band pale yellow, series of white submarginal spots complete around both wings.

*Genitalia*. Like *E. eunice*, slightly wider, in dorsal view posterior border of juxta almost flat (slide no. 1027). ♀ genitalia not examined.

DISTRIBUTION. Ecuador.

*Eresia mechanitis* Godman & Salvin comb. rev., stat. rev.

(Figs 139, 423)

*Eresia mechanitis* Godman & Salvin, 1878a: 269; Godman & Salvin, 1882: 183, pl. 20, figs 13, 14. Lectotype ♀, NICARAGUA: Chontales (*Janson*) (BMNH, Type no. Rh. 8557; Gabriel, 1927: 79), designated by Godman & Salvin, 1882: 184 [examined].

*Phyciodes mechanitis* (Godman & Salvin) Röber, 1913: 447, pl. 90, row h [fig. 5] (♂).

? *Phyciodes mechanitis* f. *daguana* Bargmann, 1928: 236. Holotype ♂, COLOMBIA: Rio Dagua (via Joicey to BMNH?—not found).

*Phyciodes eunice mechanitis* (Godman & Salvin); Hall, 1929: 159; Forbes, 1945: 167.

Like *E. eunice*, ♂ forewing 27 mm, upperside first oblique band continues to outer margin (in *eunice* ceases abruptly in *s*3, or dwindles to a narrow line along *v*3), apical yellow band defined, forming a wide black preapical band (in *eunice* yellow apical markings are vestigial or absent); hindwing outer margin angled at *v*7 (less acutely angled in *eunice*). ♀ similar.

*Genitalia*. Like *E. eunice*, scaphial extension short, spiny bosses relatively large, posterior border of juxta convex (slide no. 1243). ♀ not examined.

DISTRIBUTION. Nicaragua, Costa Rica, ? Colombia.

DISCUSSION. Hall considered *E. mechanitis* to be a subspecies of *E. eunice*. Represented in the BMNH by 4 ♂, 3 ♀, in which the markings are constant; the series does not associate well with *E. eunice*. The genitalic characters are equivocal in this group.

*Eresia pelonia* Hewitson comb. rev.

(Figs 140–142, 424, 425)

*Eresia pelonia* Hewitson, [1852]: [59], pl. [30], fig. 3. LECTOTYPE ♂, ECUADOR: 'Quito' (BMNH, Type no. Rh. 8559; Gabriel, 1927: 95), here designated [examined].

*Eresia ithomiola* Salvin, 1869: 171. LECTOTYPE ♂, PERU: Cosnipata Valley (*H. Whitely*) (BMNH, Type no. Rh. 8560; Gabriel, 1927: 66), here designated [examined].

*Eresia pelonia* Hewitson; Hewitson, [1870]: [35], pl. [20], figs 64–67 [fig. 66, f. *ithomiola*].

*Phyciodes callonia* Staudinger, 1885: 92, pl. 36. 2 ♂, 1 ♀ syntypes, PERU: Pebas; Jurimaguas (*Hahnel*) (MNHU, Berlin).

*Phyciodes callonia* var. *murena* Staudinger, 1885: 92. 2 syntypes, PERU: Chanchamayo (? MNHU, Berlin).

*Eresia callonioides* Strand, 1912b: 181. Holotype ♀, PERU (BMNH) [examined].

*Phyciodes pardalina* Röber, 1913: 447, pl. 90, row h [fig. 6]. LECTOTYPE ♂, PERU: Pebas, xii. 1906 (*de Mathan*) (BMNH) here designated [examined]. [Specimen bears Röber's M/S determination label.]

*Phyciodes pardalina apicalis* Röber, 1913: 447, pl. 90, row i [fig. 1]. LECTOTYPE ♂, PERU: Rio Chuchurras, R. Palcazu, 320 m (*W. Hoffmanns*) (BMNH) here designated [examined]. [Specimen bears Röber's M/S determination label.]

- Phyciodes murena heliconina* Röber, 1913: 447. LECTOTYPE ♀, PERU: Pebas, xii. 1906 (*de Mathan*) (BMNH), here designated [examined]. [Specimen bears Röber's M/S' determination label.]
- Phyciodes murena* Staudinger; Röber, 1913: 447, pl. 92, row c [fig. 1] (♀—as *Eresia*).
- Phyciodes pella* [sic!] (Hewitson) Röber, 1913: 446, pl. 92, row b [fig. 4] (as *Eresia*).
- Eresia callonioides* var. *pastazana* Strand, 1920: 147. Holotype ♀, ECUADOR: Upper Pastaza, c. 1000 m, x-xii. 1906 (BMNH) [examined].
- Phyciodes pelonia* f. *hewitsonii* Hall, 1929: 164. Holotype ♀, ECUADOR (BMNH) [examined].
- Phyciodes pelonia pelonia* (Hewitson); Hall, 1929: 161; Forbes, 1945: 167.
- Phyciodes pelonia* f. *callonia* Staudinger; Hall, 1929: 162.
- Phyciodes pelonia* f. *pardalina* Röber; Hall, 1929: 163.
- Phyciodes pelonia* f. *apicalis* Röber; Hall, 1929: 163.
- Phyciodes pelonia* f. *ithomiola* (Salvin); Hall, 1929: 163.
- Phyciodes pelonia* f. *heliconina* Röber; Hall, 1929: 163.
- Phyciodes pelonia* f. *callonioides* (Strand); Hall, 1929: 164.
- Phyciodes (Eresia) pelonia apicalis* Röber; Forbes, 1945: 167.
- Phyciodes (Eresia) pelonia callonia* Staudinger; Forbes, 1945: 168.
- Phyciodes (Eresia) pelonia callonioides* (Strand); Forbes, 1945: 168.
- Phyciodes (Eresia) pelonia heliconina* Röber; Forbes, 1945: 168.
- Phyciodes (Eresia) pelonia hewitsonii* Hall; Forbes, 1945: 168.
- Phyciodes (Eresia) pelonia ithomiola* (Salvin); Forbes, 1945: 168.

♂ forewing 26–28 mm, upperside fulvous, with or without yellow postdiscal band, and with black markings, forewing apex usually broadly black; hindwing upperside fulvous, subcostal and discal stripes black, submarginal spots white (if present), best developed on underside. ♀ similar, larger. (For principal colour forms see 'Discussion'.)

*Genitalia*. ♂, in dorsal view, tegumen rather narrow, shoulders not prominent, scaphial bosses appear incompletely developed with large spines on the external aspects on each side, posterior border of juxta almost straight; penis specifically distinctive, posterior section massive, slightly sinuous (slide no. 2558). ♀ not examined.

DISTRIBUTION. Peru, Ecuador, Bolivia, Brazil ('Amazonas').

DISCUSSION. This species is extremely variable. Three principal phenotypes are recognised which, according to Hall (1929), may all fly together; their genitalia are similar. These are described below as 'forms'.

1. ♂ upperside fulvous, forewing postdiscal band yellow, wing apex black; hindwing fulvous, costal and transverse bars black.

Recorded from Upper Amazon, Peru and Ecuador, f. *pelonia*.

2. ♂ upperside as in f. *pelonia*, but forewing upperside without yellow post-discal band; hindwing broadly black, by extension of costal and transverse black bars, submarginal black border absent. This form occurs in both sexes.

Recorded from Peru, Ecuador and Bolivia, f. *ithomiola* (= *murena*; *apicalis* is similar).

3. Like f. *pelonia*, but forewing apical areas enclose yellow subapical spots which may be large; hindwing upperside often more or less suffused with black. A form close to f. *pelonia*, but with forewing apical areas slightly spotted, was named *pardalina* by Röber.

Recorded from Ecuador (most common in ♀), f. *callonia* (= *hewitsonii*).

### *Eresia phillyra* Hewitson comb. rev.

(Figs 143, 144, 185, 426, 427)

*Eresia phillyra* Hewitson, [1852]: [59], pl. [30], fig. 1. ♀ syntype(s), MEXICO (W. W. Saunders Coll.; probably in UM, Oxford), several ♀ specimens of 'phillyra' ex Hewitson in BMNH.

*Eresia ezorias* Hewitson, [1857]: [44], pl. [22], fig. 13. Lectotype ♂, MEXICO (BMNH, Type no. Rh. 8562; Gabriel, 1927: 49), here designated [examined].

*Phyciodes phillyra* (Hewitson) Röber, 1913: 448; pl. 92, row c [figs 3, 4] (as *Eresia*); Hall, 1929: 167.

*Phyciodes (Eresia) phillyra phillyra* (Hewitson); Forbes, 1945: 168, 189.

♂ upperside fulvous, markings black; ♂ forewing 26–27 mm, narrow, apex truncate, outer margin excavate, wing margins black, oblique post-discal band complete; hindwing with black transverse bar below centre, prominent. ♀ larger, forewing 32 mm, broader, apex more rounded, outer margin straight, upperside markings as in ♂, but apical and marginal spots pale yellow.

*Genitalia.* ♂ like *E. eunice*, terminal bosses of scaphial extension well defined, posterior border of juxta almost straight; penis massive (slide no. 2569).

**DISTRIBUTION.** Mexico, Guatemala, ? Honduras, ? Brazil.

*Eresia aveyrona* Bates comb. rev., stat. rev.

(Figs 145, 428)

*Eresia aveyrona* Bates, 1864: 192.

♂ forewing very narrow, upperside fulvous, oblique costal bar and wing margins black. ♀ similar, forewing slightly wider.

*Genitalia.* ♂ like *E. perna*, scaphial extension narrower, spiny bosses less prominent (single preparation). ♀ not examined.

**DISTRIBUTION.** The Guyanas, Brazil (on Lower Amazon), Venezuela, Costa Rica, Ecuador.

Two subspecies, with similar genitalia.

*Eresia aveyrona aveyrona* Bates

(Figs 145, 428)

*Eresia aveyrona* Bates, 1864b: 192, pl. 10, fig. 4. Holotype ♀, BRAZIL Aveyros, on the Tapajos (*H. W. Bates*) (BMNH, Type no. Rh. 8543; Gabriel, 1927: 20), [examined].

*Phyciodes aveyrona* (Bates) Staudinger, 1885: 93; Röber, 1913: 446, pl. 92, row d [fig. 3] (as *Eresia*).

*Phyciodes perna aveyrona* (Bates); Hall, 1929: 153; Forbes, 1945: 165.

♂ forewing 24 mm, outer margin slightly excavate, upperside fulvous yellow, veins lined black, fulvous apical macule divided. ♀ forewing wider, upperside hindwing orange submarginal line more prominent.

**DISTRIBUTION.** The Guyanas, Brazil, Venezuela, Costa Rica.

*Eresia aveyrona mylitta* Hewitson nom. rev., stat. n.

*Eresia mylitta* Hewitson, 1869a: 26 [index], LECTOTYPE ♂, ECUADOR: St. Ines (*Buckley*) (BMNH, Type no. Rh. 8544; Gabriel, 1927: 21, as *bella*), here designated [examined].

*Eresia bella* Hewitson, 1869a: ii. [Unjustified replacement name for *Eresia mylitta* Hewitson; originally proposed by Kirby who intended to place *mylitta* Hewitson in the same genus as the older proposed nominal species *Melitaea mylitta* Edwards.]

[*Eresia bella* Hewitson; Hewitson, [1870]: [37], *Eresia* pl. 9, fig. 71.]

*Phyciodes bella* Kirby, 1871: 177. [Replacement name proposed by Kirby on transferring *mylitta* (Hewitson) and the older established *mylitta* (Edwards) both to *Phyciodes*; Kirby was apparently unaware that Hewitson had already published the name in the form of an unjustified replacement.] Syn. n.

*Phyciodes bella* Kirby; Röber, 1913: 446, pl. 88, row i [fig. 2] (♂).

*Phyciodes perna bella* (Hewitson); Hall, 1929: 153; Forbes, 1945: 162, 166.

♂ forewing 22.5 mm, smaller, upperside bright fulvous, veins not lined black, apical fulvous macule not divided. ♀ not seen.

**DISTRIBUTION.** Ecuador.

**DISCUSSION.** *Eresia mylitta* is placed here as a subspecies with *E. aveyrona*. It appears to be present only in Ecuador, and rather isolated from nominate *aveyrona*, which is not recorded from this region. The butterflies are rare and more information is required before their true relationship can be decided.

*Eresia perna* Hewitson comb. rev.

(Figs 146, 429)

*Eresia perna* Hewitson, [1852]: [60], pl. [30], fig. 5. LECTOTYPE ♂, BRAZIL: Rio de Janeiro (BMNH, Type no. Rh. 8545; Gabriel, 1927: 95), here designated [examined].

*Phyciodes alma* Staudinger, 1885: 93, pl. 36 (♂). ♂, ♀ syntypes, BRAZIL: Sta Catharina, Blumenau (MNHU, Berlin).

*Phyciodes perna* (Hewitson) Röber, 1913: 446, pl. 92, row g [figs 4, 5] (as *Eresia*).

*Phyciodes perna perna* (Hewitson); Hall, 1929: 152; Forbes, 1945: 165.

♂ forewing 21 mm, very elongate, upperside black, markings yellow to cream, an obscure basal stripe across cell terminates in a yellow spot in s<sub>2</sub>, a second more distal spot is placed in s<sub>4</sub>; hindwing upperside black, with yellow transverse band. ♀ larger, forewing 25 mm, broader, apex more rounded, post-discal spots tend to cream-white.

*Genitalia*. ♂ tegumen short in dorsal view, shoulders prominent, scaphial terminal bosses appear oval, well defined, spines small and irregular, posterior border of juxta with central prominence, saccus wide, tapering (slide no. 2716). ♀ not examined.

DISTRIBUTION. Brazil (coastal districts from Espirito Santo southwards to Santa Catarina, rare and local, flying in dense vegetation; Keith Brown, pers. comm.).

*Eresia levina* Hewitson comb. rev.

(Figs 151, 430, 431)

*Eresia levina* Hewitson, [1872]: [29], pl. [15], fig. 78; Fassl, 1912: 122 (♀). Syntype(s) ♂, COLOMBIA: 'New Granada' (W. W. Saunders Coll.; probably in UM, Oxford).

*Morpheus felderi* Hopffer, 1874: 351. Holotype ♂, [COLOMBIA] (not 'Bolivia' according to K. S. Brown in litt.) (*Warscewicz*) (MNHU, Berlin).

*Phyciodes levina* (Hewitson) Staudinger, 1885: 94, pl. 36 (♀); Röber, 1914: 450, pl. 92, row e [fig. 3] (♂—as *Eresia*); Hall, 1930: 189; Forbes, 1945: 163, 189.

*Phyciodes levina* f. *decorata* Röber, 1914: 450. Syntypes, COLOMBIA (depository unknown).

? *Phyciodes levina werneri* Hering, in Hering & Hopp, 1925: 193. Holotype ♀, COLOMBIA: Rio Micay (MNHU, Berlin).

*Phyciodes levina* ab. *decorata* Röber; Hall, 1930: 180; Forbes, 1945: 163.

♂ forewing 24 mm, upperside black, discal band gleaming blue, otherwise unmarked. ♀ slightly larger, blue discal band edged white.

*Genitalia*. Distinctive, large, ♂ tegumen firmly chitinized, shoulders prominent, dorsal and ventral aspects of scaphial extension extensively chitinized but spiny bosses weakly developed, posterior border of juxta sinuous, terminal section of valve armed along inner aspect with fine teeth; penis apex rounded, ostium-keel absent (slide no. 98). ♀ not examined.

DISTRIBUTION. Colombia.

*Eresia actinote* Salvin comb. rev.

(Figs 152, 153, 432)

*Eresia actinote* Salvin, 1869: 171. LECTOTYPE ♂, PERU: Cosnipata Valley (*H. Whitely*) (BMNH, Type no. Rh. 8573, Gabriel, 1927: 6), here designated [examined].

*Eresia acraea* Hopffer, 1874: 349. ♂ syntype(s), PERU (MNHU, Berlin).

*Phyciodes actinote* (Salvin) Röber, 1913: 448; pl. 92, row f [fig. 2] (♂—as *Eresia*).

*Phyciodes actinote limbata* Röber, 1913: 448; Hall, 1930: 191. ♂ syntype(s), BOLIVIA (depository unknown)

**Syn. n.**

*Phyciodes actinote actinote* (Salvin); Hall, 1930: 190.

*Phyciodes* (*Eresia*) *actinote* (Salvin); Forbes, 1945: 164, 189.

♂ forewing 24–25 mm, upperside both wings orange-brown, veins and margins black, forewing with a wide black band which runs obliquely from costa to outer margin at s<sub>2</sub>. ♀ unknown.

*Genitalia*. ♂ tegumen narrow in dorsal view, scaphial extension short, shoulders well defined, terminal



bosses large, heavily spined, posterior border of juxta gently convex, saccus short, harpes robust, slightly curved (slide no. 618).

DISTRIBUTION. Peru, Ecuador, Bolivia.

*Eresia selene* (Röber) **comb. n., stat. rev.**

(Figs 154, 433, 434)

*Phyciodes selene* Röber, 1913: 445, pl. 90, row f [figs 7, 8]. LECTOTYPE ♂, COLOMBIA: Cañon de Tolima, 1700 m, i. 1910 (*A. H. Fassl*) (BMNH), here designated [examined]. [Specimen bears Röbers M/S determination label.]

*Phyciodes etia selene* Röber; Hall, 1929: 72.

*Phyciodes (Eresia) claudina selene* Röber; Forbes, 1945: 159, 189.

♂ forewing 16–17 mm, upperside fulvous, margins and costal band black to outer margin; hindwing discal area fulvous, underside paler with confused grey markings. ♀ similar.

*Genitalia.* ♂ tegumen wide, strongly chitinized, scaphial extension well defined, lateral walls and terminal spiny bosses chitinized, posterior border of juxta gently convex, saccus wide, short, posterior process of valve massive but short (slide no. 832). ♀ not examined.

DISTRIBUTION. Colombia, Ecuador.

DISCUSSION. The ♂ genitalia of this species are typical of *Eresia*, but in general habitus and wing-markings there is an approach to species of the genus *Tegosa*, which has led to previous uncertainty as to the position of this species.

**CASTILIA gen. n.**

Type-species: *Eresia castilla* Felder & Felder. Gender: feminine.

In external characters the species are most variable, but they divide naturally into a non-mimetic group, and a mimetic group composed of the first five species described below, all mimics of *Actinote* species. All these occur in the mountainous regions of north-western South America; the females are rare, perhaps unknown in *C. neria* and *C. northbrundii*. In four species (*C. perilla*, *C. castilla*, *C. occidentalis* and *C. neria*) the venation of the forewings is unusual, vein 11 arising at or a little beyond the cell-end. In the hindwings the lower discocellular vein arises at or close to the junction of v2 and v3. These four species also show a distinctive character in the palpi, which are clothed with such long and abundant hair-scales that the terminal segments are almost hidden. The sexes differ.

The non-mimetic species have the forewings elongate, with pale markings on a dark ground, and are variable in size, with one species (*C. angusta*) quite small. Wing venation is normal and the palpal hairs are not conspicuously long, but relationship with the mimetic group is evident in the structure of the male and female genitalia. With the exception of *C. fulgora*, all these species were associated with *C. perilla* by Forbes (1945) in his group 12. In the non-mimetic forms the sexes are usually similar. In the mimetic group the special characters of the palpi and the unusual wing-venation could be taken as calling for generic separation. I have not suggested this as the group is small and generic separation would mask the relationship to the remaining species.

*Genitalia.* ♂ in dorsal view, tegumen short, un-armed, often feebly chitinized, valve terminating in a single point, curved strongly upwards in characteristic fashion, preceded by a slight dilatation and lacking pre-apical teeth, saccus deeply cleft in all species; penis straight, often massive, ostium-keel well developed. ♀ sterigma like *Eresia*, bursal duct usually chitinized and well formed, bursal support large, the usual lateral ribs exceptionally well developed in some species (e.g. *C. eranites*).

DISTRIBUTION. The generic range extends through central and western South America, including Colombia, Venezuela, Peru, Ecuador and Bolivia. The species *C. angusta* reaches NW. Argentina and Brazil in the Mato Grosso. With the exceptions of *C. fulgora* and *C. fausta*, there are adequate series of all species in the BMNH collections, but often from a single locality only. Especially in the non-mimetic group, the external characters of all species seem to be stable.

Key to species of *Castilia*

## Males.

*Note.* It has not been practicable to include *C. griseobasalis* (p. 156) and *C. chinantlensis* (p. 157) in this key.

In *C. eranites*, females are like males with additional white postdiscal spots. Females of *C. neria* and of *C. nortbrundii* are not known; those of *C. occidentalis* are very rare. Females resemble males in *C. angusta*, *C. fulgora*, *C. ofella* and *C. myia* (probably also in *C. fausta*, but not yet described). The species *C. griseobasalis* and *C. chinantlensis* have not been included in the key; the former is closely related to *C. myia*, the latter to *C. eranites*.

- |   |  |  |
|---|--|--|
| 1 | Mimetic of <i>Actinote</i> , hindwing underside lined dark along and between veins | 2  |
| - | Markings variable, not mimetic of <i>Actinote</i>                                  | 5  |
| 2 | Hindwing upperside costal margin white   | <i>nortbrundii</i> (p. 154)                            |
| - | Hindwing upperside costal margin dark  | 3  |
| 3 | Forewing upperside basal area fulvous, postdiscal area black, unmarked             | <i>neria</i> (p. 154)                                  |
| - | Forewing upperside not so marked   | 4  |
| 4 | Forewing upperside postdiscal band red, yellow or white, width 8 mm or more        | <i>perilla</i> (p. 153)                                |
| - | Forewing upperside postdiscal band red, width 4 mm or less                         | <i>castilla</i> (p. 152), <i>occidentalis</i> (p. 153) |
| 5 | Forewing 14 mm, very elongate, width 6 mm, or less                                 | <i>angusta</i> (p. 157)                                |
| - | Forewing wider, species larger   | 6  |
| 6 | Upperside markings fulvous on black  | 7  |
| - | Upperside markings white or pale yellow  | 8  |
| 7 | Forewing upperside wide fulvous band extending from base to post-discal area       | <i>eranites</i> (p. 155)                               |
| - | Forewing upperside base black  | <i>fulgora</i> (p. 155), <i>fausta</i> (p. 155)        |
| 8 | Forewing upperside with white spot at cell-end                                     | <i>ofella</i> (p. 156)                                 |
| - | Forewing upperside lacking white spot at cell-end                                  | <i>myia</i> (p. 156)                                   |

## Females, mimetic species.

- |   |  |                              |
|---|--|------------------------------|
| 1 | Forewing upperside base yellow-buff  | <i>perilla</i> (p. 153)      |
| - | Forewing upperside base black  | 2                            |
| 2 | Hindwing upperside discal area red-brown, black area matt                    | <i>castilla</i> (p. 152)     |
| - | Hindwing upperside inner margin shaded red, black area with blue reflections | <i>occidentalis</i> (p. 153) |

*Castilia castilla* (Felder & Felder) comb. n.

(Figs 155, 156, 435-437)

*Eresia castilla* Felder & Felder, 1862b: 419; Felder & Felder, 1867: 395, pl. 50, figs 7-10; Röber, 1913: pl. 91, row b [fig. 2]; pl. 92, row e [fig. 2]. LECTOTYPE ♂, COLOMBIA: Bogota Cordillera, near Pandi, 5600 ft. [1700 m] (*Lindig*) (BMNH), here designated [examined].

*Phyciodes castilla* (Felder & Felder) Röber, 1914: 450.

*Phyciodes castilla* ♀ f. *virilis* Röber, 1914: 450. ♀ syntype(s), COLOMBIA (depository unknown).

*Phyciodes castilla castilla* (Felder & Felder); Hall, 1930: 191.

*Phyciodes (Tritanassa) castilla castilla* (Felder & Felder); Forbes, 1945: 185, 190.

♂ forewing 25-26 mm, upperside black, discal band red, oblique, 3-5 mm wide; hindwing upperside black, unmarked; hindwing underside yellow-grey, 2 small basal red marks and radiating black stripes along and between veins. ♀ larger, forewing 27-28 mm, upperside dark grey, discal band irregular, yellow, 4-6 mm wide; hindwing upperside dark grey, base and discal area brown with black radiating stripes as on underside; a male-like ♀ form (*virilis*), with upperside dark grey-brown and discal band red, has been recorded by Röber.

*Venation* (Fig. 437). Forewing stalk of veins 7-10 arises with v11 and v6 at cell-end.

*Genitalia*. ♂ tegumen short, scaphial extension weakly chitinised, conical, posterior border of juxta slightly concave, harpe massive at base but tapering rapidly (slide no. 615). ♀ ductus and bursal support firmly chitinised, the large scutum especially noticeable.

DISTRIBUTION. Colombia (not recorded elsewhere).

*Castilia occidentalis* (Fassl) comb. n., stat. n.

(Figs 147, 148, 438–440)

*Eresia castilla* f. *occidentalis* Fassi, 1912: 122. ♂, ♀ syntypes, COLOMBIA: West Cordillera, 1500–2000 m (depository uncertain—MNHU, Berlin?).

*Eresia castilla occidentalis* Fassi; Röber, 1913: pl. 91, row c [fig. 1]; pl. 92, row e [fig. 2].

*Phyciodes castilla occidentalis* (Fassl) Röber, 1914: 450; Hall, 1930: 192; Forbes, 1945: 185.

? *Phyciodes aurora* Röber, 1914: 449; pl. 91, row b [fig. 3] (as *Eresia*); Hall, 1930: 192; Forbes, 1945: 190 (as ? ♀ of *castilla*). LECTOTYPE ♀, ECUADOR: 'Zamora, 3000–4000 ft.' (*O. T. Baron*) (BMNH) here designated [examined]. [Specimen bears Röber's M/S determination label.]

♂ forewing 21 mm, like *C. castilla* but smaller, upperside black, red postdiscal band more oblique and narrower. ♀ larger, upperside gleaming black, forewing discal band slightly wider, red or yellowish; hindwing with red anal mark which fades away near discoidal cell. The nominal species *aurora* Röber may represent a ♀-form of *occidentalis*; specimens of this sex are extremely rare.

*Venation*. Stalk of v7–v11 divides a little beyond cell, first discocellular vein present but short, v6 free.

*Genitalia*. ♂ similar to *C. castilla* but smaller, in dorsal view structure of tegumen less well defined, posterior border of juxta gently convex, valve apex bowed inwards, pre-apical bulge not greatly developed (slide no. 626).

DISTRIBUTION. Colombia, Ecuador.

*Castilia perilla* (Hewitson) comb. n.

(Figs 149, 150, 175, 176, 441–443)

*Eresia perilla* Hewitson, [1852]: [60], pl. [30], fig. 4. LECTOTYPE ♂, ECUADOR: 'Quito' (BMNH, Type no. Rh. 8567; Gabriel, 1927: 95), here designated [examined].

*Eresia acraeina* Hewitson, [1864]: [17], pl. [9], fig. 15. LECTOTYPE ♂, [PERU] 'Upper Amazon' (BMNH, Type no. Rh. 8568; Gabriel, 1927: 6), here designated [examined].

*Eresia aricilla* Hopffer, 1874: 350. ♂ syntypes, PERU: Chanchamayo (*Thamm*) (MNHU, Berlin).

*Eresia heliconoides* Butler, 1877: 120. LECTOTYPE ♂, PERU: Ucayali (*W. Davis*) (BMNH, Type no. Rh. 8569; Gabriel, 1927: 58), here designated [examined].

*Phyciodes perilla* (Hewitson) Staudinger, 1885: 94.

*Phyciodes acraeina* f. *hilarina* Röber, 1913: 448, pl. 92, row e [fig. 5] (as *Eresia acraeina*). Syntypes, 'Andes' (depository unknown).

? *Phyciodes neria* f. *microdryope* Röber, 1913: 448, pl. 92, row e [fig. 4] (as *Eresia*). Syntype(s), COLOMBIA (depository unknown).

*Eresia amoenides* Röber, 1913: pl. 92, row f [fig. 1]. [Published without description.]

*Phyciodes acraeina* ♀ f. *aberrans* Röber, 1913: 448, pl. 91, row a [fig. 5] (as *Eresia acraeina*). ♀ syntype(s), 'Andes' (depository unknown).

*Phyciodes perilla lugubris* Röber, 1914: 450. Syntypes, PERU (depository unknown).

*Phyciodes pellenea* Röber, 1914: 450, pl. 91, row c [fig. 2] (as *Eresia*). LECTOTYPE ♀, BOLIVIA: Reyes (*Stuart*) (BMNH), here designated [examined]. [Specimen bears Röber's M/S determination label.]

*Phyciodes perilla perilla* (Hewitson); Hall, 1930: 194.

*Phyciodes perilla* f. *acraeina* (Hewitson); Hall, 1930: 194; Forbes, 1945: 186.

*Phyciodes perilla* f. *aricilla* (Hopffer); Hall, 1930: 195; Forbes, 1945: 186.

*Phyciodes perilla* f. *lugubris* Röber; Hall, 1930: 195.

*Phyciodes perilla* ♀ f. *aberrans* Röber; Hall, 1930: 196; Forbes, 1945: 185.

*Phyciodes perilla* ♀ f. *pellenea* Röber; Hall, 1930: 196; Forbes, 1945: 185.

*Phyciodes* (*Tritanassa*) *perilla* f. *perilla* (Hewitson); Forbes, 1945: 185, 190.

? *Phyciodes pellenea crucifera* Bryk, 1953: 92. Holotype ♀, PERU: Roque (NR, Stockholm).

A polymorphic and variable species; ♂ forewing 23 mm, upperside black, wing bases usually more or less flushed red, discal band on forewing in various shades of red to yellow and cream-white; hindwing underside yellow-brown, base often flushed reddish, and rayed black along and between veins. ♀ larger, forewing 27–33 mm, upperside dark grey, base yellow-brown, discal band curved, yellow, slightly irregular; hindwing broadly yellow-brown, margin grey, lightly rayed dark along and between veins. For description of colour forms, see 'Discussion'.

*Venation*. Forewing v11 and v7–v10 arise together.

*Genitalia*. ♂ in dorsal view like *C. castilla*, slightly smaller, tegumen weakly chitinised, exposing on each side a broad plate of the inferior lamina of the scaphial extension; posterior border of juxta slightly irregular, convex; valve terminal process short, turned medially (slide no. 627). ♀ ductus short, bursal support with strong ribs.

DISTRIBUTION. Ecuador, Peru, Bolivia, ? Colombia.

DISCUSSION. The polymorphism has not been investigated as far as I know. Hall (1930: 194) states 'forms are not geographically separated, although some are more prevalent in certain localities than others'. The principal colour forms are named as follows.

- 1, ♂ band of forewing pale yellow, bases of both wings broadly flushed red, f. *perilla*;
- 2, ♂ band of forewing and wing-bases red, f. *acraeina*;
- 3, ♂ band of forewing red, base of hindwing black, f. *aricilla*;
- 4, like *aricilla*, but band of forewing yellow (mimic of *Eueides aides* Stichel and *Archonias bella* (Cramer), f. *lugubris*;
- 5, ♀ forewing basal suffusion and band yellow, and vestigial yellow apical markings, f. *pellenea*;
- 6, forewing band and both wing bases yellow, colour extensive on hindwing, f. *aberrans*.

### *Castilia neria* (Hewitson) comb. n.

(Figs 157, 444-446)

*Eresia neria* Hewitson, 1869c: 98; Hewitson, 1869a: 27; [1872]: [29], pl. [15], fig. 80. LECTOTYPE ♂, ECUADOR: Sarayacu (Buckley) (BMNH, Type no. Rh. 8572; Gabriel, 1927: 85), here designated [examined].

*Phyciodes neria* (Hewitson) Röber, 1914: 449; Hall, 1930: 197.

*Phyciodes (Tritanassa) neria* (Hewitson); Forbes, 1945: 185, 190.

♂ forewing 21 mm, upperside black, wide basal area orange-fulvous, hindwing black; underside forewing apex and all hindwing grey-brown, rayed black along and between veins. ♀ unknown.

*Venation*. Forewing v11 and stalk of v7-v10 arise together, beyond cell-end.

*Genitalia*. ♂ like *C. perilla*, tegumen short, scaphial extension fragile, membranous; posterior border of juxta rather prominent; terminal process of valve curved sharply medially; penis robust (slide no. 619).

DISTRIBUTION. Ecuador.

### *Castilia northbrundii* (Weeks) comb. n.

(Figs 158, 447-449)

*Phyciodes northbrundii* Weeks, 1901: 359; Weeks, 1905: 96, pl. 42, fig. 1 (♂). 4 ♂ syntypes, BOLIVIA: Cochabamba district (MCZ, Cambridge).

*Eresia nebrites* Weymer, 1907: 19. Holotype ♂, BOLIVIA: Cochabamba (*Fruhstorfer*) (? MNHU, Berlin).

*Phyciodes actinotina* Röber, 1914: 449; pl. 91, row b [fig. 7] (as *Eresia*). ♂ syntype(s), BOLIVIA (depository unknown).

*Phyciodes northbrundii* Weeks; Hall, 1930: 197.

*Phyciodes (Tritanassa) northbrundii* Weeks; Forbes, 1945: 185, 190.

♂ forewing 19 mm, upperside black, large basal area and oblique subapical band orange-fulvous; hindwing discal area orange-fulvous; underside hindwing pale grey, rather faintly rayed dark brown along and between veins, sometimes a few small orange markings near base. ♀ unknown.

*Venation*. In forewing v11 arises from subcostal vein before end of cell. This is the normal arrangement found in other Phyciadini.

*Genitalia*. ♂ tegumen short, lateral walls of scaphial extension chitinised and projecting posteriorly; posterior border of juxta gently curved, saccus short, posterior process of valve long, slender, curved medially, harpe slender; in side view penis like *C. perilla* (slide no. 611).

DISTRIBUTION. Bolivia.

*Castilia eranites* (Hewitson) **comb. n.**

(Figs 159, 160, 450–452)

*Eresia eranites* Hewitson, [1857]: [43], pl. [22], figs 8–10; Godman & Salvin, 1882: 185; 1901: 673. LECTOTYPE ♂, COLOMBIA: Bogota ('New Granada') (BMNH, Type no. Rh. 8547; Gabriel, 1927: 46), here designated [examined].

*Phyciodes eranites* (Hewitson) Staudinger, 1885: 93; Röber, 1913: 446; Hall, 1929: 164; Forbes, 1945: 184, 190.

*Eresia evanides* [sic!] Hewitson; Röber, 1913: pl. 92, row c [fig. 5]; row d [figs 1, 2].

[*Eresia carme* Doubleday; Röber, 1913: pl. 92, row d [fig. 3]. Misidentification; aberrant specimen with unusual hindwing marking.]

*Phyciodes eranites mejicana* Röber, 1913: 446. Syntype(s), MEXICO: Presidio (depository unknown).

*Phyciodes* (*Eresia*) *eranites mejicana* Röber; de la Maza, 1978: 39–44, figs 2a, b, 3b.

♂ forewing 22 mm, upperside fulvous with black markings along costa and margins, defining a large basal and discal orange area, and smaller orange costal and submarginal spots; hindwing orange, borders black with prominent black macular band almost parallel with the outer margin, equally conspicuous on underside. ♀ larger, markings differ slightly, post-discal area of forewing spots more numerous, white.

*Genitalia.* ♂ apical section of valve slender, apex curved strongly inwards, harpe firmly chitinized, tegumen weakly chitinized, slightly conical, fragile, posterior border of juxta protruding posteriorly, forming an acute angle, saccus large, deeply cleft; penis straight, massive, ostium-keel small (slide no. 2587). ♀ genitalia, ductus short, bursal support large, posterior rib prominent.

DISTRIBUTION. Mexico, Costa Rica, Nicaragua, Salvador, Panama, Guatemala, Venezuela, Colombia.

*Castilia fulgora* (Godman & Salvin) **comb. n.**

(Figs 161, 453, 454)

*Phyciodes fulgora* Godman & Salvin, 1878b: 261; Godman & Salvin, 1882: 206, pl. 22, figs 17, 18; Röber, 1913: 445, pl. 90, row f [fig. 6]; Hall, 1929: 106; Forbes, 1945: 182, 190. LECTOTYPE ♂, COSTA RICA: Rio Sucio (*H. Rogers*) (BMNH, Type no. Rh. 8456; Gabriel, 1927: 52), here designated [examined].

*Phyciodes levana* Röber, 1913: 440, pl. 88, row h [fig. 7]. ♀ syntype(s), COSTA RICA: Orosi, 1280 m (*A. H. Fassl*) (depository uncertain).

♂ forewing 15 mm, like *C. fulgora* but smaller, outer margin slightly excavate, upperside dark brown bar on discoidal vein, a large oval postdiscal spot in s1b, s2 and s3, and a subapical costal bar before a very small, white apical spot; hindwing with a narrow orange transverse band tapering to v1b; underside hindwing pale brown with confused cryptic markings. ♀ similar, forewing upperside orange postdiscal spot expanded to form a wide postdiscal band; hindwing upperside white submarginal spot in s7 prominent.

*Genitalia.* ♂ in dorsal view rather narrow, tegumen and scaphial extension lightly chitinized; posterior border of juxta gently undulant, terminal process of valve curved medially, harpe slender; penis like *C. perilla* (slide no. 1021). ♀ not examined.

DISTRIBUTION. Seen only from Costa Rica.

*Castilia fausta* (Godman & Salvin) **comb. n.**

(Figs 162, 455)

*Phyciodes faustus* Godman & Salvin, 1897: 243; 1901: 680, pl. 108, figs 19, 20 (♂); Röber, 1913: 441; Hall, 1929: 79; Forbes, 1945: 181, 190. ♂ syntype(s), PANAMA: Chiriqui, ex *Staudinger* (MNHU, Berlin).

♂ forewing 15 mm, like *C. fulgora* but smaller, outer margin slightly excavate, upperside dark brown (black when fresh?), markings fulvous, spot at cell-end small; hindwing fulvous transverse band tapering to inner margin, submarginal lunules obscure excepting well-marked spot in s7; underside marbled light and dark brown. ♀ not seen.

*Genitalia.* ♂ in dorsal view like *C. fulgora*, tegumen shorter, scaphial extension not well defined, posterior border of juxta wide with small undulations; falces parallel, not oblique (slide no. 1345).

DISTRIBUTION. Panama (Chiriqui).

A rare species, two males only in BMNH.

*Castilia ofella* (Hewitson) **comb. n.**

(Figs 163, 456–458)

*Eresia ofella* Hewitson, [1864]: [18], pl. [9], figs 18, 19; Godman & Salvin, 1882: 189; 1901: 674. Syntype(s), COLOMBIA: 'New Granada' (E. Birchall Coll.; present depository uncertain, possibly in UM, Oxford; not recorded by Gabriel, 1927, but 'type' noted by Hall, 1929: 135, as being in BMNH).

*Phyciodes ofella* (Hewitson) Röber, 1913: 444, pl. 90, row f [fig. 3] (♂).

*Phyciodes ofella ofella* (Hewitson); Hall, 1929: 134.

? *Phyciodes ofella guaya* Hall, 1929: 135. Holotype ♂, ECUADOR (BM, Brighton) [paratype ♂ in BMNH examined].

*Phyciodes (Tritanassa) ofella ofella* (Hewitson); Forbes, 1945: 183, 185, 190.

*Phyciodes (Tritanassa) ofella guaya* Hall; Forbes, 1945: 183.

♂ forewing 19 mm, outer margin excavate, upperside black, markings white; small spot over cell-end, large postdiscal mark in s1b–s3 which is placed to continue the white transverse band of the hindwing, a few small spots near wing apex; hindwing upperside veins crossing white transverse band not pigmented; hindwing underside distal area marbled brown, a row of small, dark spots present in s1c, s2 and s3. ♀ similar.

*Genitalia*. ♂ in dorsal view with tegumen very short, scaphial extension greatly reduced; posterior border of juxta with low central prominence, apical process of valve very small; harpe slender; penis as in *C. perilla* (slide no. 1063). ♀ distinctive, ductus long, chitinised, bursal support of unusual shape, partly membranous.

DISTRIBUTION. Guatemala, Costa Rica, Panama, Colombia, Venezuela, Trinidad, ? Ecuador.

*Castilia myia* (Hewitson) **comb. n.**

(Figs 164, 459–461)

*Eresia Myia* Hewitson, [1874]: [17], pl. [9], figs 16, 17; Godman & Salvin, 1882: 188; 1901: 674.

LECTOTYPE ♂, MEXICO (BMNH, Type no. Rh. 8534; Gabriel, 1927: 84), here designated [examined].

*Phyciodes myia* (Hewitson) Röber, 1913: 444, pl. 90, row e [figs 4, 5].

*Phyciodes myia myia* (Hewitson); Hall, 1929: 136; Forbes, 1945: 183.

♂ forewing 18 mm, upperside black, markings white, like *C. ofella* but lacking white cell-spot, round postdiscal spot in sb1 and sb2 conspicuous; hindwing transverse band narrow, crossed by black veins, small submarginal spot conspicuous in s7; forewing underside base orange-yellow; hindwing underside marbled brown, with a row of dark submarginal lunules in s1c–s5. ♀ similar.

*Genitalia*. ♂ like *C. eranites*, tegumen fragile, posterior border of juxta wide with small undulations, valve tapering posteriorly to slender, upturned apex, rather sharply curved, harpe gently curved (slide no. 2586). ♀ genitalia: bursal duct chitinised, support well defined with prominent ribs.

DISTRIBUTION. Mexico, Honduras, Nicaragua, Guatemala.

*Castilia griseobasalis* (Röber) **comb. n., stat. n.**

(Figs 165, 462, 463)

*Phyciodes myia* f. *griseobasalis* Röber, 1913: 444. Syntype(s), [CENTRAL AMERICA] (depository unknown).

*Phyciodes myia griseobasalis* Röber; Hall, 1929: 137.

*Phyciodes (Anthanassa) myia griseobasalis* Röber; Forbes, 1945: 183, 190.

♂ forewing 15 mm, variable, upperside like *C. myia*, but smaller, pale markings reduced, especially the white postdiscal spot in s1b–s2; hindwing white transverse band narrow; forewing underside base yellow-grey.

*Genitalia*. ♂ like *C. myia*, in dorsal view posterior section of valve conspicuously long, harpe straight, long and slender (slide no. 1038).

DISTRIBUTION. Guatemala, El Salvador, Costa Rica, ? Mexico.

DISCUSSION. Hall states that *C. griseobasalis* replaces *C. myia* in western Guatemala, El Salvador and Costa Rica. The distinction between the two in size and markings is far from striking, but it appears to be constant; I have not seen specimens with intermediate characters.

*Castilia angusta* (Hewitson) comb. n.

(Figs 166, 464–466)

*Eresia angusta* Hewitson, [1868]: [34], pl. [19], figs 58, 59. LECTOTYPE ♂, locality unknown (BMNH, Type no. Rh. 8535; Gabriel, 1927: 13), here designated [examined].

*Phyciodes angusta* (Hewitson); Röber, 1913: 445, pl. 92, row h [fig. 6] (♂); Hall, 1929: 137.

*Phyciodes (Tritanassa) angusta* (Hewitson); Forbes, 1945: 185, 190.

♂ forewing 14 mm, narrow, elongate, outer margin weakly excavate, upperside black, markings pale yellow, small narrow bar at cell-end, round postdiscal spots in s2 and s3 prominent; hindwing upperside with transverse band and isolated submarginal spot in s7, submarginal lunules vestigial if present. ♀ similar.

*Genitalia*. In dorsal view ♂ organs wide, tegumen fragile, posterior border of juxta very prominent, valve tapering, rather massive, apex inclined medially, harpe slender; penis ostium-keel present, morula small (slide no. 2762). ♀ bursal duct chitinised, support well formed, scutum large.

DISTRIBUTION. Colombia, Ecuador, Peru, Bolivia, Brazil (Mato Grosso), Argentina (Tueumán).

*Castilia chinantlensis* (de la Maza) comb. n.

(Figs 171, 172)

*Phyciodes (Eresia) chinantlensis* de la Maza, 1978: 39, figs 1a–c, 3a [3, 4-cover]. Holotype ♂, MEXICO: La Esperanza, Sierra de Juarez, Oaxaca, 1750 m, 27.xi.1976 (*R. de la Maza*) (Museo de Historia Natural de la Ciudad de Mexico) [1 ♂, 1 ♀ paratypes examined in BMNH].

De la Maza, in his original description, provides good photographs of the adults (including colour figures of both sexes on the rear cover of the journal issue), and a dorsal view of the male genitalia.

*Genitalia* (based on examination of paratype in BMNH). ♂ very close to *C. eranites*; in dorsal view the tegumen is well defined, nearly quadrilateral; valve less curved posteriorly; posterior margin of juxta appears evenly and gently convex.

DISTRIBUTION. Mexico (known only from the Sierra de Juarez, Oaxaca).

DISCUSSION. *C. chinantlensis* is compared by de la Maza with *Eresia phillyra*, and particularly with *C. eranites* (for the Mexican population of which de la Maza retains the subspecies *mejicana*). On account of the close similarity to *C. eranites*, *chinantlensis* is transferred here to *Castilia*.

*JANATELLA* gen. n.

Type-species: *Eresia leucodesma* Felder & Felder. Gender: feminine.

Rather small butterflies, forewing outer margin straight or slightly convex, never excavate, uppersides black with white markings; forewing with costal mark beyond cell and large white mark on centre of inner margin; hindwing upperside discal band prominent; underside dark ocellar postdiscal spots well defined in s3, s4 and s5. Sexes similar.

*Genitalia*. ♂ in dorsal view with tegumen elongate, not tapered, scaphial extension short, posterior angles well defined, each bearing 3–5 teeth or small hooks (Fig. 467); saccus single (lingulate) with shallow apical notch in *J. hera*, posterior border of juxta gently convex, penis slender, morula not prominent, ostium-keel very small (possibly absent in the type-species). ♀ ductus not chitinised, bursal support attached to a low elevation, ribs little developed.

DISTRIBUTION. Nicaragua, Panama, northern South America, St. Vincent and Trinidad.

DISCUSSION. The three species *C. leucodesma*, *C. hera* and *C. fellula* were united by Forbes (1945: 189) as his group 6 (*Eresia*). The facies of all are very different from other species in the *Eresia* series, and by the shape of the dorsal structures of the male genitalia, appear allied more closely to *Phyciodes*. All are clearly related and they form a small group most suitably placed in a separate genus.

**Key to species of *Janatella* (based on Forbes, 1945: 161)**

- 1 Base of forewing beneath light buff, ground colour of hindwing white, except towards the margin 2
- Base of forewing underside ash grey, ground colour of hindwing dull grey; forewing rarely, if ever, with white in cell . . . . . *fellula* (p. 159)
- 2 White the dominant colour, extending over more than half of hindwing, and nearly half of forewing (Colombia to Trinidad) . . . . . *leucodesma* (p. 158)
- White markings limited to spots on forewings and a median band on the hindwings (Guianas) . . . . . *hera* (p. 158)

***Janatella leucodesma* (Felder & Felder) comb. n., stat. rev.**

(Figs 167, 467-470)

*Eresia leucodesma* Felder & Felder, 1861: 103; 1867: 394, pl. 50, figs 11, 12. LECTOTYPE ♀, VENEZUELA: Caracas Province, Moritz (BMNH, specimen ex Felders' Coll., ex Rothschild Coll.), here designated [examined].

*Eresia cincta* Edwards, 1864: 502. ♂ syntypes, U.S.A.: 'Texas, Florida' [C. America?] (lost) (see Brown, 1966: 428).

*Phyciodes leucodesma* (Felder & Felder) Godman & Salvin, 1882: 197; Staudinger, 1885: 92, pl. 36; Röber, 1913: 444, pl. 90, row f [figs 1, 2]; Hall, 1929: 132.

*Phyciodes (Eresia) ianthe leucodesma* (Felder & Felder); Forbes, 1945: 161, 189.

*Anthanassa cincta* Edwards; Holland, 1947: 141. [Holland indicates that this taxon is probably identical with *leucodesma*.]

*Anthanassa (?) leucodesma* (Felder & Felder); Holland, 1947: 141, pl. 73, fig. 7.

♂ forewing 16 mm, upperside wing-base and costa black to postdiscal costal bar, a large white area extends from costal margin to meet costal mark; hindwing upperside white except extreme base and black marginal border. ♀ similar, often slightly larger.

*Genitalia*. ♂ in dorsal view, posterior angles of long, scaphial extension each bears 5 small teeth curved medially, saccus single, valve apex with 2 terminal teeth (slide no. 1349). ♀ genitalia, bursal duct incompletely chitinised.

DISTRIBUTION. Trinidad, Island of St. Vincent, Panama, Nicaragua, Colombia, Venezuela.

DISCUSSION. In spite of the wide distribution, the species is remarkably stable in external characters and genital structure.

***Janatella hera* (Cramer) comb. n.**

(Figs 168, 471, 472)

*Papilio hera* Cramer, [1779]: 108, pl. 253, figs F, G. Syntype(s), [SOUTH AMERICA] ('Sierra Leona') (depository unknown).

*Papilio ianthe* Fabricius, 1781: 80. Syntype(s), FRENCH GUIANA: Cayenne ('Mus Dom Yates', presumably lost, illustrated in 'Jones Icones', Oxford, not listed by Zimsen). [Junior homonym of *Papilio ianthe* Pallas, 1771.]

*Phyciodes hera* (Cramer) Kirby, 1871: 175; Röber, 1913: 443, pl. 90, row e [figs 2, 3].

*Phyciodes ianthe* (Fabricius) Hall, 1929: 133.

*Phyciodes (Eresia) ianthe ianthe* (Fabricius); Forbes, 1945: 161, 189.

♂ forewing 20 mm, upperside markings like *Castilia ofella*, but outer margin of wing not excavate, hindwing upperside white submarginal spot absent (constantly present in *C. ofella*). ♀ similar.

*Genitalia*. ♂ like *J. fellula*, dorsal structures elongate, in dorsal view scaphial angles rather densely chitinised with 3-4 large teeth, saccus apex weakly notched (slide no. 830). ♀ not examined.

DISTRIBUTION. French Guiana, Surinam.

NOTE. The excellent figure in Jones's unpublished Icones (Hope Department of Zoology, Oxford) shows *ianthe* Fabricius to be identical with *hera* Cramer.



*Janatella fellula* (Schaus) **comb. n.**

(Figs 169, 473, 474)

*Phyciodes fellula* Schaus, 1902: 393. Holotype ♂, COLOMBIA (USNM; Type no. 5885) [examined]. [*Phyciodes abas* (Hewitson); Röber, 1913: 443, pl. 90, row e [fig. 6] (♂); Hall, 1929: 115; Forbes, 1945: 161, 189. Misidentifications.]

♂ forewing 17–19 mm, variable, upperside black, markings white, cell-spot very small, larger spots in s2 s3 and s4 in oblique series; hindwing upperside white transverse band 2.0–2.5 mm, extends from s7 to inner margin. ♀ similar.

**Genitalia.** ♂, in dorsal view, tegumen wide, elongate, well chitinised, scaphial terminal angles armed with 3 or 4 teeth, posterior border of juxta gently convex, saccus variable, wide, tapering rapidly, or longer and more uniform in width in some specimens (slide no. 101). ♀ genitalia like *J. leucodesma*, ductus partly chitinised with goblet-shaped bursal support.

**DISTRIBUTION.** Ecuador, Colombia.

**NOTE.** The wing markings of this species are very like those of *Telenassa abas*, in which the white transverse band on the hindwing upperside extends only from s6 to s1b, i.e. it does not quite reach to the inner margin.

**MAZIA gen. n.**

Type-species: *Melitaea amazonica* Bates. Gender: feminine.

In both sexes wings broad, appearing large in comparison with the thorax and abdomen; upperside ground-colour fulvous with delicate black markings, arranged in series parallel with the wing-margins. Antennae less than half the length of forewing, club slender, cylindrical (Fig. 491). Palpi elongate, slightly ascending, terminal segment acicular.

**Venation.** Forewing cell closed, v11 arising beyond cell-end from stalk of v7–10; hindwing cell open.

**Genitalia.** ♂ in dorsal view, tegumen very short, a bunch of strong spines arising at each posterior angle of the scaphial extension, valve in side view wide, posterior process short with 2 terminal teeth, posterior margin of juxta gently convex; saccus elongate, apex notched; penis straight, morula inconspicuous. ♀ genitalia, ductus bursae appears to be firmly chitinised as a saccular structure with bursa attached by a membranous collar, unlike the arrangement present in all other genera.

**DISCUSSION.** The single species, *M. amazonica*, has strongly divergent characters, not only in the structure of antennae, palpi and in venation, but also the wing-markings, which show a pattern dissimilar to that of any other known species. Forbes (1945) placed *amazonica* as the sole species in his *Phyciodes* (*Eresia*) group 7. The distribution is confined to the Amazon Region, but quite extensive, reaching the eastern areas of Ecuador and Peru.

*Mazia amazonica* (Bates) **comb. n.**

(Figs 170, 475–479)

*Melitaea amazonica* Bates, 1864b: 190. LECTOTYPE ♂, BRAZIL: Tapajos (*H. W. Bates*) (BMNH, Type no. Rh. 8522; Gabriel, 1927: 11), here designated [examined].

*Phyciodes amazonica* (Bates) Staudinger, 1885: 91, pl. 36 (♀); Röber, 1913: 435, pl. 89, row b [figs 8, 9] (♂); Hall, 1929: 62, pl. 3, fig. 3 (genit.).

*Phyciodes* (*Eresia*) *amazonica* (Bates); Forbes, 1945: 161, 189.

♂ upperside bright fulvous, markings black, striae arranged partly in series parallel with the black outer margins of the wings, hindwing with a row of postdiscal dots; underside yellowish, markings as on upperside but grey, series more complete. ♀ similar.

**Genitalia.** As described above.

**DISTRIBUTION.** Brazil (including Mato Grosso), E. Peru, Ecuador.

### Species incertae sedis

#### *Phyciodes melini* Bryk

*Phyciodes melini* Bryk, 1953: 88. Holotype ♀, PERU: Roque, 6.iv.1925 (NR, Stockholm)

#### *Phyciodes metharmeoides* Fassl

*Phyciodes metharmeoides* Fassl, 1922: 38. Holotype ♀, BRAZIL: 'Innern von Teffe' (depository unknown).

#### *Phyciodes rima* Hall

*Phyciodes rima* Hall, 1929: 79. Holotype ♂, SURINAM ('interior') (C. W. Ellacombe) (BMNH) [examined].  
*Phyciodes (Tritanassa) rima* Hall; Forbes, 1945: 190.

This taxon is based on a single specimen, now lacking the abdomen. It probably belongs to the genus *Telenassa*.

#### *Phyciodes mirabilis* Hayward

*Phyciodes mirabilis* Hayward, 1967: 13–15, fig. Holotype ♀, ECUADOR: Puyo, ix.1960 (*J. Foerster*) (IML, Tucumán).

#### *Phyciodes eucrasia* Zikan

*Phyciodes eucrasia* Zikan, 1937: 385. 1 ♂, 2 ♀ syntypes, BRAZIL: São Gabriel, Rio Negro, viii, is, x (MNRJ, Rio de Janeiro).

#### *Phyciodes chinchipensis* Hayward

*Phyciodes chinchipensis* Hayward, 1964a: 63, fig. Holotype ♂, PERU: Rio Chinchipe, afluyente norteño del Rio Marañón, 500–700 m (*W. Weyrauch*) (IML, Tucumán).

This species is not represented in the BMNH collection. It is a small butterfly, ♂ wing expanse 20–22 mm, ♀ 23–24 mm. On the upperside the ground colour is yellow, markings black, with a wide postdiscal area of the forewing with small yellow spots and markings; on the hindwing upperside the postdiscal series of spots is rather prominent, as seen from the original figure. Hayward considered *P. chinchipensis* to be closely related to *Phystis simois*. The genitalia have not been figured.

### Supplement on certain genera of Melitaeini

The genus *Gnathotriche*, and the closely related genus *Gnathotrusia*, were not included in my descriptive account of the American *Chlosyne* and related genera (Higgins, 1960). This omission is corrected here, and the butterflies described in similar style and detail. Most of the species were included by Hall (1928b–1930) in *Phyciodes*, but Forbes (1945) corrected this error, grouping them in *Gnathotriche*. The four species involved, together with the small genus *Higginsius*, form a group of special interest, divergent from all other American Melitaeini, although the usual tribal characters are present. Outstanding group characters include the unusual venation of the forewing and the structure of the male genitalia, which are generally elongate, the posterior section of the valve very slender, curved and tapering to a pointed apex. The species all occur in Colombia, Venezuela and N. Peru. In *Gnathotrusia*, wing-markings in the male are mimetic and without any value to show relationships, but the genitalia structure shows, as does that of *Gnathotriche*, an astonishing similarity in general structure, and in several details, to the genitalia of *Didymaeformia didyma* and its allies, with extensive Palaearctic distributions. The similarity includes the shape of the tegumen, the presence of brachia (sub-unci), and the shape of the valve and harpe. Within the subfamily these features are so unusual that a real relationship must be accepted to exist between these species and the *didyma*-group, which suggests very wide dispersal of the *didyma* precursors at some distant epoch.

#### GNATHOTRICHE Felder & Felder

*Gnathotriche* Felder & Felder, 1862b: 420, *nota*. Type-species: *Euterpe exclamationis* Kollar, by monotypy.

Rather small or medium-sized butterflies, forewing outer margin excavate below v5; palpi ascending, middle segment slightly inflated and with dense long black hairs, terminal segment acicular. Upperside ♂ markings dark brown with white or pale yellow spots. The females differ.

*Venation.* Forewing v10 arises near v11 and before cell-end, branching to v9 running to wing-apex, v8 running to outer margin with v7 branching at about one-third of its length; beyond v10 the subcostal continues as first discoidal vein with branch as v6, then continues as middle discoidal vein with branch as v5, and then continues as lower discoidal vein to meet the median vein at v4. Hindwing venation normal, with cell open.

*Genitalia.* ♂, in dorsal view, tegumen weakly chitinised, narrow, tapering, terminal section membranous, posterior border of juxta conical (*exclamationis*) or rounded (*sodalis*), lingulae densely chitinised, saccus cleft, valve elongate, the posterior section slender, strongly curved inwards and tapering gradually to a single point, the saccular element well defined with a small harpe directed forwards; penis slender, slightly longer than saccus plus valve, dilated beyond manica, then tapering to a gaping ostium, lacking ostium crest and morula.

**DISTRIBUTION.** Colombia, Venezuela.

The species are said to inhabit forests in hilly and mountainous country; they do not occur at high altitudes.

### *Gnathotriche exclamationis* (Kollar)

(Figs 480–483)

*Euterge exclamationis*, [1849]: 359, pl. 45, figs 5, 6. ♂ syntype(s), VENEZUELA (NM, Vienna).

*Gnathotriche exclamationis* (Kollar) Felder & Felder, 1862b: 420, *nota*; Staudinger, [1885]: 95, pl. 36;

Röber, 1914: 454, pl. 88, row g [figs 2–5] (♂, ♀); Forbes, 1945: 190; 1946: 196, fig. 1 (genit.).

*Eresia elaea* Hewitson, 1869a: 25 [index]; [1872]: [29], pl. [15], figs 81, 82. Lectotype ♀, ECUADOR: Rio Verde (*Buckley*) (BMNH, Type no. Rh. 8581; Gabriel, 1927: 43), here designated [examined].

*Eresia eleates* Weymer, 1907: 18, pl. 2, fig. 5. Holotype ♀, COLOMBIA, 'coll. Fruhstorfer' (depository uncertain).

*Phyciodes vanessoides* Röber, 1914: 449, pl. 91, row b [fig. 5]. ♀ syntype(s), COLOMBIA: Bogota (NMHU, Berlin).

*Phyciodes eleates* (Weymer) Röber, 1914: 449, pl. 91, row a [figs 6, 7].

*Gnathotriche exclamationis* f. *eresia* Röber, 1914: 454, pl. 88, row g [fig. 6]. ♀ syntypes, COLOMBIA and VENEZUELA (MNHU, Berlin).

*Gnathotriche exclamationis* ♀ f. *eresia* Röber, 1946: 196.

*Gnathotriche exclamationis* ♀ f. *eleates* (Weymer); Forbes, 1946: 196.

*Gnathotriche exclamationis* ♀ f. *elaea* (Hewitson); Forbes, 1946: 196.

*Gnathotriche exclamationis* ♀ f. *vanessoides* (Röber); Forbes, 1946: 196.

♂ forewing 19 mm, apex truncate, outer margin excavate, upperside black, markings cream-white, a short basal streak in cell and a spot at cell-end, postdiscal costal bar of 3 elongate spots, and other postdiscal and submarginal spots; hindwing upperside a wide transverse band from costa to inner margin, crossed by dark veins. ♀ slightly larger, variable and differs greatly. In one form similar to ♂ but all markings orange-fulvous; more often wing-apex rounded, outer margin of forewing less excavate, upperside black with an irregular discal cream-white bar on forewing upperside, designated 'typical' by Röber. In a third female form (f. *eresia* Röber), the upperside is black, except a wide fulvous area on the forewing extending from the base along inner margin and costa about half-way to apex.

*Genitalia.* ♂, in dorsal view, posterior border of juxta conical; harpe of valve well developed. ♀ ostium bursae open, leading directly to bursal duct, bacilli weakly chitinised, bifid, but accompanied by numerous membranous fibrils to compose a single united rod, scutum not large.

**DISTRIBUTION.** Colombia, Venezuela.

**DISCUSSION.** In females the variation is very great and specific attribution is very largely a matter of guesswork.

### *Gnathotriche sodalis* Staudinger

(Figs 484–486)

*Gnathotriche sodalis* Staudinger, [1885]: 95; Röber, 1914: 454, pl. 88, row g [figs 7, 8] (♂); Forbes, 1945: 190; 1946: 196. ♂ syntypes, COLOMBIA: Cauca Valley (MNHU, Berlin).

♂ forewing 20 mm, outer margin deeply excavate; ground-colour brown, markings yellow, rather obscured by brown scales, spot in mid-cell and at cell-end, discal spots in s1b, and at bases of s2 and s3, costal bar of 4 or 5 short stripes, submarginal series of spots often incomplete, but a white spot in s6 constant; hindwing upperside with 4 or 5 small discal spots forming a broken transverse band not suffused brown, postdiscal and submarginal markings vestigial. ♀ not known.

*Genitalia.* ♂ densely chitinised, in dorsal view tegumen fragile, easily distorted, posterior border of juxta semicircular, prominent, harpe very small; penis slender, as long as valve, ostium crest prominent (?everted), morula absent.

DISTRIBUTION. Colombia (Cauca Valley).

NOTE. *G. sodalis* appears to be a very local and rare species. Seven males in the BMNH are all from Staudinger, ex Godman & Salvin, clearly part of the original type-material. The species is not represented in Hall's collection.

### GNATHOTRUSIA gen. n.

Type-species: *Eresia mundina* Druce. Gender: feminine.

Butterflies of medium size, palpi like *Gnathotriche*, hairy, terminal segment acicular; forewing apex rounded, outer margin straight. Upperside markings mimetic of *Actinote* species, polymorphic, underside like *Gnathotriche*, apex of forewing and all hind wing greyish, lined black along and between veins.

*Venation.* Like *Gnathotriche* but in forewing v5 arises close to v6 so that middle discocellular vein is shortened, but remains easily identifiable.

*Genitalia.* Male like *Gnathotriche* but differ in the densely chitinised conical tegumen, produced posteriorly to terminate abruptly; differs also in presence of prominent, cylindrical brachia, strongly chitinised, their medial borders armed with fine spines; saccus cleft.

DISTRIBUTION. Restricted to Colombia and N. Peru.

### *Gnathotrusia mundina* (Druce) comb. n.

(Fig. 487)

*Eresia mundina* Druce, 1876: 221, pl. 18, fig. 4. Holotype ♂, PERU: Huiro, Santana Valley (*H. Whitely*) (BMNH, Type no. Rh. 8570; Gabriel, 1927: 83), [examined].

*Phyciodes fallax* Staudinger, 1885: 94. 1 ♂, 3 ♀ syntypes, PERU: Chanchamayo (MNHU, Berlin).

*Phyciodes rosina* Dognin, 1888: 48, fig.; Röber, 1914: 449. Lectotype ♂, ECUADOR: 'Numbala River' ('environs de Loja' on specimen) (BMNH) here designated [examined]. [Specimen bears Dognin's M/S 'type' label.]

*Eresia crina* Schaus, 1902: 392. Holotype, ECUADOR (USNM, Type no. 5884) [examined].

[*Eresia acraea* Hopffer; Röber, 1913: pl. 92, row f [fig. 3]. Misidentification.]

*Phyciodes erebia* Röber, 1914: 449, pl. 91, row b [fig. 6]. LECTOTYPE, PERU: Cushi, Huanuco province, 1900 m, (*W. Hoffmans*) (BMNH) here designated [examined]. [Specimen bears Röber's M/S determination label.]

*Phyciodes hopfferi* Röber, 1914: 449; pl. 92, row f [fig. 3] (as *Eresia acraea*). Syntype(s), PERU (depository unknown).

*Phyciodes crina* (Schaus) Röber, 1913: 448.

*Phyciodes mundina* (Druce) Röber, 1914: 450.

*Phyciodes mundina peraea* Hall, 1928a: 13. Holotype ♂, ECUADOR (BMNH) [examined].

*Phyciodes mundina f. callianira* Hall, 1930: 200. Holotype ♂, PERU (BM, Brighton) [examined].

*Phyciodes mundina mundina* (Druce); Hall, 1930: 198.

*Phyciodes mundina f. hopfferi* Röber, Hall, 1930: 199.

*Phyciodes mundina f. fallax* Staudinger; Hall, 1930: 199.

*Phyciodes mundina f. rosina* Dognin; Hall, 1930: 200.

*Phyciodes mundina f. crina* (Schaus); Hall, 1930: 201.

*Phyciodes mundina f. erebia* Röber; Hall, 1930: 201.

*Phyciodes mundina f. peraea* Hall; Hall, 1930: 201, pl. 2, fig. 7 (♂).

*Phyciodes mundina f. testacea* Hall, 1935: 221. LECTOTYPE ♂, BOLIVIA: Coroico (BMNH), here designated [examined: Hall stated 'type' to be from Coroico, in BM; I have labelled middle specimen of 3 from Coroico as lectotype, no specimens having been labelled by Hall].

*Gnathotriche mundina* (Druce); Forbes, 1945: 141–5, 190.

? *Phyciodes erebia mima* Bryk, 1953: 90. Holotype ♂, PERU: Roque (NR, Stockholm).

♂ forewing 22–23 mm, upperside black, polymorphic, markings most variable, orange-fulvous, rosy red, pink etc.; in nominate form forewing a wide orange-red postdiscal bar extends from costa to s3; hindwing upperside gleaming blue-black, underside, all veins lined sooty-black; in f. *hopfferi*, upperside forewing basal area orange-fulvous, hindwing with basal area of same colour; in f. *peraea*, forewing upperside postdiscal band narrow, buff, running to s1b, basal colour absent from both wings; f. *rosina* is like *hopfferi*, but with upperside markings rose-red. These and other variants occur at random in individual specimens, and usually an obvious model in *Actinote* can be recognised.

*Genitalia*. ♂ in dorsal view like *Gnathotriche exclamations*, but in dorsal view tegumen large, an elongate conical shape; brachia prominent.

DISTRIBUTION. Restricted to Colombia and N. Peru.

### *Gnathotrusia epione* (Godman & Salvin) comb. n.

(Figs 488, 489)

*Eresia epione* Godman & Salvin, 1878b: 263. Lectotype ♂, COLOMBIA: Antioquia (*Salmon*) (BMNH, Type no. Rh. 8571; Gabriel, 1927: 46), here designated [examined].

*Phyciodes epione* (Godman & Salvin) Staudinger, 1885: 94; Röber, 1914: 449, pl. 91, row b [fig. 4] (as *Eresia*).

*Phyciodes styx* Staudinger, 1885: 94. 10 syntypes, COLOMBIA: Antioquia (MNHU, Berlin).

*Eresia callianthina* Hall, 1921: 279. 2 [♀] syntypes, COLOMBIA: Santa Elena, 2900 m (BM, Brighton).

*Phyciodes epione elenae* Hall, 1928: 13. Holotype ♂, COLOMBIA: Santa Elena, 2900 m (BM, Brighton) [examined].

*Phyciodes epione epione* (Godman & Salvin); Hall, 1930: 202; Forbes, 1945: 190.

*Phyciodes epione* f. *styx* Staudinger; Hall, 1930: 203.

*Phyciodes epione elenae* Hall; Hall, 1930: 203, pl. 2, fig. 8 (♂).

*Phyciodes callianthina* (Hall) Hall, 1930: 203, pl. 2, fig. 9 (♀).

*Phyciodes epione callianthina* Hall; Forbes, 1945: 190.

♂ forewing 23 mm, upperside both wings gleaming metallic deep blue, shading to black along forewing costa and outer margins; hindwing inner margin bright red; underside black, apex of forewing and all hindwing shading to greyish, with black lines along and between veins. Wing-markings variable, in f. *styx* hindwing upperside inner margin black; in f. *elenae* similar with forewing underside with red basal area; f. *callianthina* has forewing upperside base red, underside red area extensive. ♀ illustrated by Hall (1930: pl. 2, fig. 9).

*Genitalia*. ♂ like *G. mundina*, in dorsal view elongate, tegumen firmly chitinised, domed with a narrow central extension ending abruptly, brachia stout, juxta wide, tapering to a rounded apex, lingulae very dense.

DISTRIBUTION. Restricted to Colombia.

### *HIGGINSIUS* Hemming

*Fulvia* Higgins, [1959]: 162. Type-species: *Melitaea fasciata* Hopffer, by original designation. [Homonym of *Fulvia* Gray, 1853, and *Fulvia* Adams, 1957.]

*Higginsius* Hemming, 1964: 139. [Replacement name for *Fulvia* Higgins.]

The genus is defined, the species described, and anatomical characters figured in Higgins (1960: 460–462).

Important characters include forewing venation as in *Gnathotriche* and in hindwing v7 branches from subcostal vein some distance before the fork with v5 and v6; palpi conspicuous, long and very hairy. In the minute genitalia the tegumen is narrow, the apical section of the valve curved inwards, very slender and sharply pointed, the saccus small with shallow terminal notch.

DISTRIBUTION AND RELATIONSHIPS. The genus *Higginsius* includes two species (*H. fasciatus*, *H. miriam*) with restricted distributions in Ecuador, W. Colombia and probably in Venezuela. The curious wing-venation, the long, densely hairy palpi and the genitalic characters, with the

slender, pointed valve apex, all point to close relationship with *Gnathotriche*, in spite of the very different facies. The species are not mimetic or cryptic, and in *fasciata* the upperside wing-markings show the common ancestral pattern of black striae on a fulvous ground. Both species appear to be very local and rare. Females are unknown.

### ANTILLEA Higgins

*Antillea* Higgins, [1959]: 164; Riley, 1975: 78-79, pl. 6. Type-species: *Papilio pelops* Drury, by original designation.

The genus is defined, the species are described and anatomical characters are figured in Higgins (1960: 462-465).

Important generic characters include forewing venation as in *Gnathotriche*. In the hindwing veins 5, 6 and 7 all arise from a common point on the subcostal vein; veins 1a and 1b are slightly displaced to make room for a hair-pencil. The minute genitalia are unusual, the tegumen very shallow, the valve in side view blunt, the harpe relatively large, and with a prominent saccular tooth near the blunt apex. The penis massive, with ostium-crest and vestigial morula. ♀ (a single specimen examined) appears to have a short, double bacillus.

In spite of the apparently primitive venation of the forewing, this genus does not agree well with the genus *Didymaeformia*. With several unusual and unique characters, the two species (*pelops*, *proclea*) are probably relics of great antiquity, and, without obvious relationship to any other extant group, difficult to place today. The ♀ examined cannot belong to the *Phyciodes* section, and I have included *Antillea* within the Melitaeini as an independent genus.

### Review of the classification of the Melitaeinae

The publication of this account of the tribe Phyciodini, and of the genera *Gnathotriche* and *Gnathotrusia*, completes the study of the Melitaeinae, which was begun in the *Illustrated Catalogue of the Palaearctic Melitaea*, published by the Royal Entomological Society of London in 1941. This is, therefore, a suitable opportunity to review the conclusions reached then and in subsequent papers, and to examine the classification of the whole subfamily. In considering the relationships of the three principal tribes, I have commented upon species living in restricted habitats, divergent species, and especially upon such interesting features of distribution as specific and generic disjunctions. It is necessary to include a formal description of the subfamily, and a catalogue at tribal and generic levels. Roger Verity, who was the first entomologist to introduce subfamily status for the Melitaeinae, insisted that the large genus *Melitaea* required further division, and I agree with his suggestions. To make a more meaningful arrangement it is necessary to divide *Melitaea* into four generic groups. For one of these, the name *Mellicta* is now generally recognised; for the two remaining groups, suitable generic names are available, and these are now resurrected. A new genus, for which the name *Gnathotrusia* has been proposed above, is required for two species associated with the divergent *Gnathotriche* group of South America. No other taxonomic changes are suggested.

On the basis of the characters of the male and female genitalia, it is easy to recognise three major groups of tribal rank, and possibly a fourth tribe is required for the small genus *Atlantea*, the three species of which appear divergent in relation to all other genera. All species show the key family and subfamily characters, but at tribal level each group is entirely isolated. Species with intermediate or equivocal characters have not been seen. The tribes can be defined precisely as follows.

1	Male genitalia, saccus absent . . . .	EUPHYDRYINI
-	Male genitalia, saccus present . . . .	2
2	Female genitalia with bacillus . . . .	MELITAEINI
-	Female genitalia without bacillus . . . .	3
3	Female genitalia with bursal support . . . .	PHYCIODINI
-	Female genitalia without bursal support . . . .	? tribe

**Check-list of tribes, generic groups, genera and species of the Melitaeinae**

The type-species of genera are marked with an asterisk; junior synonyms are not included unless they are type-species.

**EUPHYDRYINI** Higgins (Holarctic)*EUPHYDRYAS* Scudder\**phaeton* (Drury)*HYPODRYAS* Higgins\**maturna* (L.)*intermedia* (Ménétriès)*cynthia* (Denis & Schiffermüller)*iduna* (Dalman)*gillettii* (Barnes)*OCCIDRYAS* Higgins\**ancia* (Doubleday)*chalcedona* (Doubleday)*editha* (Boisduval)*colon* (Edwards)*EURODRYAS* Higgins\**aurinia* (Rottemburg)*alexandrina* (Staudinger)*desfontainii* (Boisduval)*orientalis* (Herrich-Schäffer)**MELITAEINI** Tutt (Holarctic and Neotropical)*MELICTA*-group (Palearctic)*MELICTA* Billberg\**athalia athalia* (Rottemburg)*athalia celadussa* (Fruhstorfer)*athalia ambigua* (Ménétriès)*deione* (Geyer)*parthenoides* (Keferstein)*aurelia* (Nickerl)*britomartis* (Assmann)*varia* (Meyer-Dur)*asteria* (Freyer)*centralasiae* (Wnukowsky)*rebeli* (Wnukowsky)*menetriesi* (Caradja)*plotina* (Bremer)*alatauica* (Staudinger)*DIDYMAEFORMIA*-group<sup>1</sup> (Palearctic except *Poladryas*)*MELITAEA* Fabricius*avinovi* Sheljuzhko*arduinna* (Esper)\**cinxia* (L.)*balba* Evans*minerva* Staudinger*pallas* Staudinger*turanica* Erschoff*agar* Oberthür*asteroidea* Staudinger*diamina diamina* (Lang)*diamina regama* Fruhstorfer

<sup>1</sup> Verity's genus *Didymaeformia* has not been accepted by most authors, partly because the designation of a type-species is somewhat ambiguous in the author's original introduction of the name (1950). It is, however, inconvenient to be without a generic name for *Papilio didyma* Esper and its many relatives in Central Asia. Verity's intention was perfectly clear and *Didymaeformia* Verity, 1950, is accepted here as a valid generic name, with type-species *Papilio didyma* Esper, as recorded by Hemming (1967).

(Note. The name is spelt *Didymaeformis* by Hemming, clearly a *lapsus calami*!)

- lukto* Evans  
*mimetica* Higgins  
*tangigharuensis* de Freina  
*romanovi* Grum-Grshimailo  
*arcesia* Bremer  
*albiba* Moore  
*sindura* Moore  
*amoenula* Felder & Felder  
*jezabel* Oberthür  
*bellona* Leech  
**POLADRYAS** Bauer  
*minuta* (Edwards)  
*\*pola* (Boisduval)  
*arachne* (Edwards)  
**DIDYMAEFORMIA** Verity  
*didyma*-group  
*\*didyma* (Esper)  
*deserticola* (Oberthür) comb. n.  
*transcaucasica* (Turati) comb. n.  
*persea* (Kollar) comb. n.  
*afghana* (Heydemann) comb. n.  
*abyssinica* (Oberthür) comb. n.  
*gina* (Higgins) comb. n.  
*mixta* (Evans) comb. n.  
*casta* (Kollar) comb. n.  
*yuenty* (Oberthür) comb. n.  
*saxatilis* (Christoph) comb. n.  
*didymina* (Staudinger) comb. n.  
*didymoides* (Eversmann) comb. n.  
*ala* (Staudinger) comb. n.  
*pseudoala* (Sheljuzhko) comb. n.  
*chitralensis* (Moore) comb. n.  
*sutschana* (Staudinger) comb. n.  
*acraeina* (Staudinger) comb. n.  
*fergana*-group  
*fergana* (Staudinger) comb. n.  
*ambrisia* (Higgins) comb. n.  
*lunulata* (Staudinger) comb. n.  
*shandura* (Evans) comb. n.  
*macarandica* (Staudinger) comb. n.  
*athene* (Staudinger) comb. n.  
*infernalis* (Grum-Grshimailo) comb. n.  
*collina*-group  
*collina* (Lederer) comb. n.  
*turkmanica* (Higgins) comb. n.  
*consulis* (Wiltshire) comb. n.  
*kuchi* (Wyatt) comb. n.  
*trivia* (Denis & Schiffermüller) comb. n.  
**CINCLIDIA** Hübner  
*\*phoebe* (Denis & Schiffermüller)  
*aetherie* (Hübner)  
*scotosia* (Butler)  
*sibina* (Alphéraky)  
*sarvistana* (Wiltshire)  
**CHLOSZYNE**-group (Nearctic and Neotropical)  
**CHLOSZYNE** Butler  
*nycteis* (Doubleday)  
*gorgone* (Hübner)



*harrisii* (Scudder)  
*hoffmanni* (Behr)  
*malcolmi* (Comstock)  
*gabbii* (Behr)  
*damaetas* (Skinner)  
*neumeogeni* (Skinner)  
*acastus* (Edwards)  
*palla* (Boisduval)  
*definita* (Aaron)  
*marina* (Geyer)  
*melitaeoides* (Felder & Felder)  
*gloriosa* Bauer  
*\*janais* (Drury)  
*poecile* (Felder & Felder)  
*erodyle* (Bates)  
*melanarge* (Bates)  
*lacinia lacinia* (Geyer)  
*lacinia saundersi* (Doubleday)  
*californica* (Wright)  
*riobalensis* Bauer  
*ehrenbergi* (Geyer)  
*narva* (Fabricius)  
*gaudealis* (Bates)  
*hippodrome* (Geyer)  
*rosita* Hall  
*marianna* Röber

**THESSALIA** Scudder

*\*leanira* (Felder & Felder)  
*theona* (Ménétrières)  
*cynisca* (Salvin)

**TEXOLA** Higgins

*\*elada* (Hewitson)  
*anomalus* (Godman & Salvin)  
*coracara* (Dyar)

**DYMASIA** Higgins

*\*dymas* (Edwards)

**MICROTIA** Bates

*\*elva elva* Bates  
*elva draudti* Röber

**GNATHOTRICHE**-group (Neotropical—South American and Antillean)**GNATHOTRICHE** Felder & Felder

*\*exclamationis* (Kollar)  
*sodalis* Staudinger

**GNATHOTRUSIA** gen. n.

*\*mundina* (Druce)  
*epione* (Godman & Salvin)

**HIGGINSIUS** Hemming

*\*fasciatus* (Hopffer)  
*miriam* (Dognin)

**ANTILLEA** Higgins

*\*pelops* (Drury)  
*proclea* (Doubleday)

**PHYCIODINI** trib. n. (Nearctic and Neotropical)**PHYCIODES** Hübner

*tharos* (Drury)  
*\*cocyta* (Cramer)  
*batesii* (Reakirt)  
*campestris campestris* (Behr)

*campestris camillus* Edwards  
*montanus* (Behr)  
*mylittus mylittus* (Edwards)  
*mylittus mexicanus* Hall  
*mylittus thebais* Godman & Salvin  
*pallidus* (Edwards)  
*orseis* Edwards  
*herlani* Bauer  
*pictus pictus* (Edwards)  
*pictus pallescens* (Felder)  
*phaon* (Edwards)  
*vesta vesta* (Edwards)  
*vesta graphica* (Felder)

**PHYSTIS** gen. n.

\**simois simois* (Hewitson)  
*simois variegata* (Röber)  
 ? *chinchipensis* (Hayward)

**ANTHANASSA** Scudder

*drusilla drusilla* (Felder & Felder)  
*drusilla lelex* (Bates)  
*drusilla alceta* (Hewitson)  
*drusilla verena* (Hewitson)  
*ptolyca ptolyca* (Bates)  
*ptolyca amator* (Hall)  
*ardys ardys* (Hewitson)  
*ardys subota* (Godman & Salvin)  
*dracaena* (Felder & Felder)  
*phlegias* (Godman & Salvin)  
*texana texana* (Edwards)  
 \**cincta* Edwards; Scudder  
*texana seminole* (Skinner)  
*alexon alexon* (Godman & Salvin)  
*alexon subconcolor* (Röber)  
*acesas* (Hewitson)  
*nebulosa* (Godman & Salvin)  
*argentea* (Godman & Salvin)  
*atronia* (Bates)  
*otanes otanes* (Hewitson)  
*otanes sopolis* (Godman & Salvin)  
*annulata* sp. n.  
*crithona* (Salvin)  
*fulviplaga* (Butler)  
*hermas* (Hewitson)  
*frisias* (Poey)  
*tulcis* (Bates)  
*dubia* (Hall)  
*taeniata* (Röber)  
*sisis* (Godman & Salvin)  
*drymaea* (Godman & Salvin)  
*sitalces* (Godman & Salvin)  
*cortes* (Hall)

**DAGON** gen. n.

*pusillus* (Salvin)  
 \**catula* (Hopffer)  
*morenus* (Röber)  
*fontus* (Hall)

**TELENASSA** gen. n.

\**teletusa* (Godart)  
*burchelli* (Moulton)

*berenice* (Felder & Felder)  
*signata* (Hall)  
*abas* (Hewitson)  
*jana* (Felder & Felder)  
*elaphina* (Röber)  
*nana* (Druce)  
*nussia* (Druce)  
*notus* (Hall)  
*gaujoni* (Dognin)  
*trimaculata* (Hewitson)  
*flavocincta* (Dognin)  
*catenaria* (Godman & Salvin)  
*delphia* (Felder & Felder)  
*sepulta* (Hall)

**ORTILIA** gen. n.

\**liriope* (Cramer)  
*gentina* sp. n.  
*orthia* (Hewitson)  
*orticus* (Schaus)  
*sejona* (Schaus)  
*velica velica* (Hewitson)  
*velica durnfordi* (Godman & Salvin)  
*zamora* (Hall)  
*dicoma* (Hewitson)  
*polinella* (Hall)  
*ithra* (Kirby)

**TISONA** gen. n.

\**saladillensis saladillensis* (Giacomelli)  
*saladillensis clarior* subsp. n.

**TEGOSA** gen. n.

\**claudina* (Eschscholtz)  
*similis* nom. n.  
*orobia* (Hewitson)  
*fragilis* (Bates)  
*infrequens* sp. n.  
*ursula* (Staudinger)  
*flavida* (Hewitson)  
*tissoides* (Hall)  
*pastazena* (Bates)  
*guatemalena* (Bates)  
*anieta anieta* (Hewitson)  
*anieta cluvia* (Godman & Salvin)  
*anieta luka* subsp. n.  
*anieta serpia* subsp. n.  
*nazaria* (Felder & Felder)  
*etia* (Hewitson)  
*nigrella* (Bates)

**ERESIA** Boisduval

*clara* Bates  
*nauplius nauplius* (Linnaeus)  
*nauplius extensa* (Hall)  
*plagiata* (Röber)  
*letitia letitia* Hewitson  
*letitia ocellata* (Röber)  
*lansdorfi* (Godart)  
*sestia* Hewitson  
*coela* Druce  
*oblita* (Staudinger)  
*carne carne* Doubleday

- carne laias* Godman & Salvin  
*polina* Hewitson  
*alsina* Hewitson  
*cissia* (Hall)  
*eutropia* Hewitson  
*mimas* (Staudinger)  
*quintilla* Hewitson  
*poecilina* Bates  
*melaina* sp. n.  
*sticta* Schaus  
*ithomioides ithomioides* Hewitson  
*ithomioides pseudocelemina* (Strand)  
*anomala* sp. n.  
*nigripennis* Salvin  
*emerantia* Hewitson  
*moesta* Salvin & Godman  
*phaedima* Salvin & Godman  
*datis datis* Hewitson  
*datis corybassa* Hewitson  
*margaretha* Hewitson  
*\*eunice eunice* (Hübner)  
*eunice olivencia* Bates  
*eunice esora* Hewitson  
*etesiae* (Hall)  
*erysice* (Geyer)  
*casaphia* Hewitson  
*mechanitis* Godman & Salvin  
*pelonia* Hewitson  
*phillyra* Hewitson  
*aveyrona aveyrona* Bates  
*aveyrona mylitta* Hewitson  
*perna* Hewitson  
*levina* Hewitson  
*actinote* Salvin  
*selene* (Röber)
- CASTILIA** gen. n.  
*\*castilla* (Felder & Felder)  
*occidentalis* (Fassl)  
*perilla* (Hewitson)  
*neria* (Hewitson)  
*nortbrundii* (Weeks)  
*eranites* (Hewitson)  
*fulgora* (Godman & Salvin)  
*fausta* (Godman & Salvin)  
*ofella* (Hewitson)  
*myia* (Hewitson)  
*griseobasalis* (Röber)  
*angusta* (Hewitson)  
*chinantlensis* (de la Maza)
- JANATELLA** gen. n.  
*\*leucodesma* (Felder & Felder)  
*hera* (Cramer)  
*fellula* (Schaus)
- MAZIA** gen. n.  
*\*amazonica* (Bates)

Tribe?

- ATLANTEA** Higgins  
*\*perezii* (Herrich-Schäffer)

*pantoni* (Kaye)

*tulita* (Dewitz)

*cryptadia* Sommer & Schwartz

### Distribution

The following account is not intended to be exhaustive, but the principal features of distribution of the Melitaeinae are described and some anomalous features are pointed out. Especially in the Palaearctic Region, the situation is complicated, and a serious difficulty arises in the absence of information and material from many parts of the U.S.S.R.

#### PALAEARCTIC REGION

The subfamily is represented by the two tribes Melitaeini and Euphydryini, with about 75 species widely distributed, forming an important faunal element. Four regions in this vast area are sufficiently distinct to need separate consideration.

*European Region, including Europe with Russia to the Urals, NW. Africa and W. Asia (Pontic distribution area)*

There is an important concentration of 22 species in W. Europe and NW. Africa, involving two faunal regions. Euro-Siberian elements are widespread in northern and central parts of the area, including the arctic, and on all mountains. Six genera are represented: *Melitaea* (*M. cinxia* and *M. diamina*); *Cinclidia* (*C. phoebe*) (see also Siberian Region below); *Didymaeformia* (*D. didyma*); *Mellicta*, the dominant genus (*M. athalia* with two major subspecies; *M. britomartis* occurs from Piedmont to Transbaical; two species, *M. asteria* and *M. varia* are endemic in the high Alps and central Apennines, two species, *M. parthenoides* and *M. aurelia*, fly at moderate altitudes in W. Europe, the latter rather widely distributed to Baltic countries and to the Caucasus); *Hypodryas* (*H. intermedia wolfensbergeri*, *H. maturna*, *H. iduna* not south of 60°N lat., *H. cynthia* only on the Alps and Balkan Mts. (also S. Caucasus?)); *Eurodryas* (*E. aurinia*).

Most of these species occur in suitable localities in S. Europe and in NW. Africa, with two additional species, *Eurodryas desfontainii* and *Cinclidia aetherie*, their ranges restricted to SW. Europe and Morocco, the latter also in Sicily. Although situated within the Mediterranean area, the taxonomic characters of these two species are closely related to the Euro-Siberian fauna. They are best placed as pre-glacial relicts (Atlanto-Mediterranean). *E. desfontainii* is closely related to *E. orientalis*, locally endemic in W. Asia. The distribution of *Cinclidia* is extensive (see below, E. Siberia).

There is an interesting situation with the two subspecies of *M. athalia*, identifiable by the distinctive characters of the male genitalia. In W. Europe the distribution of the eastern taxon *M. a. athalia* meets the western *M. a. celadussa* in central France. Here the two are known to breed together along a frontier that extends from the Atlantic to the Adriatic, producing individuals having male genitalia of intermediate character, forming a hybrid zone up to 40 miles wide. I have no doubt that the western *M. a. celadussa*, with typical Atlanto-Mediterranean distribution, is the original pre-glacial species, its range now reduced by the post-glacial invasion of *M. a. athalia*, a Siberian (Angaraland) element.

Ponto-Mediterranean species in S. Europe are few in number, as follows: *Melitaea arduinna* is local in the Balkans and in N. Greece; *Didymaeformia trivialis* is widespread in SE. Europe, with scattered colonies in N. and C. Italy, N. Spain and in Portugal. A single species occurs in NW. Africa, *D. deserticola* in S. Algeria and Tunisia.

In Asia Minor and to the east and south, there is a vast area, partly semi-desert, where the genus *Didymaeformia* is dominant at low and medium altitudes, often numerous in individuals, but the number of species is not large and includes *D. didyma* and *D. trivialis*, often common in northern areas (see p. 166). *D. deserticola macromaculata* is local in Syria, Lebanon and Israel. *D. perseae* is widely distributed, with several local races and marked seasonal variation. The range extends south to Oman in Arabia, *D. abyssinica?* (*D. a. scotti* Higgins) occurring in the mountains of Yemen and *D. a. abyssinica*, described from Ethiopia, but never recorded again from that country. The mountain fauna is remarkable for presenting several small species of

*Melitaea*, flying in rare widely distributed colonies, usually at rather high altitudes, as follows: *M. collina*, Syria, Lebanon, Iraq (Kurdistan); *M. turkmanica*, Turkmen S.S.R. ('Askabad'), Armenia (= *vedica*); *M. consulis*, Iran, S. Zagros, perhaps a subspecies of *M. turkmanica*. These three species are closely related. *D. saxatilis*, N. Iran (Mt. Demavend, Mt. Shahkuh, flying at 4,000 m). *Cinclidia sarvistana*, Iran, Zagros Mts at high altitudes (male genitalia very divergent).

#### Central Asia

In this region the Tian Shan, Pamirs and other great mountain ranges form a specialised biotope with the greatest concentration of Melitaeini in the Palaearctic region. *Didymaeformia didyma* and three related species fly in the western districts, but in general the western species disappear and their places are taken by other taxa endemic in central Asia. Among the most interesting is the *D. fergana*-group of seven species, most of which fly at altitudes of 2,500 m or more, in oreo-tundral biotopes, including *D. lunulata*, *D. shandura*, *D. ambrisia* etc. All are rare, their habitats strictly localised, but in all species the male genitalia are distinctive, with good specific characters. These stand apart from the western *D. didyma*, as a distinct endemic group within the genus. They are accompanied by four or five species of *Melitaea*, closely related to *M. cinxia*, the uppersides bright fulvous with delicate black markings. All are distributed at high altitudes on the Ala Tau, Changai, Pamirs etc., and extend into Afghanistan, each major mountain group having its special phenotype, but with the male genitalia similar in all cases. Of these, *M. minerva* is probably the most important, with a wide distribution in the Ala Tau, Pamirs, and Hindu Kush, the different races flying at various altitudes up to 3,000 m or more, with a confusing range of different phenotypes, variously graded by different authors as species or subspecies. *Cinclidia sibina* is widely distributed in E. Turkestan, Alai Mts., etc. In many ways Afghanistan is closely related to the Hindu Kush and Pamirs, with similar high mountains, but the butterfly fauna differs considerably. Five species are known which appear to be endemic to the area, all with restricted distributions as follows: *Melitaea avinovi* has been known for many years; *Didymaeformia kuchi* is a small species that flies at high altitudes; *D. afghana* data are scanty at present. In the southern districts, which lead into Baluchistan, *Melitaea lukto* and *M. mimetica* occur, flying at moderate levels, perhaps subspecies of a single taxon.

#### The Himalayas and Mongolia

In the west these mountains merge into the central Asian Karakorums and Hindu Kush in Ladak and Chitral. Two or three species of *Didymaeformia* occur here including *D. chitralensis*, which flies at moderate levels in the valleys. The principal interest lies in the small *Melitaea amoenula* (male forewing length 12 mm), which flies in Khema and Ladak at 3,500 m or more, and the larger *M. balbita* which occurs at lower levels. These are the most westerly representatives of a remarkable series of distinct but closely related races (? species) which occurs through the length of the Himalayas to the exclusion of other Melitaeinae. The series includes *M. sindura* in the north-west and *M. sikkimensis* in Sikkim and Nepal. Further east, in south-western Tibet, the series merges into *M. jezebel*, slightly larger, with the very distinct *M. bellona* at lower altitudes. In the Amdo region, the Himalayan races are represented by *M. arcesia* which flies in suitable localities near the Kuku Nor and northwards to the Changai Mts and Transbaicalia (Sajan and Kentei Mts). The entire series forms a 'Rassenkreis' which is remarkable among Palaearctic butterflies. The male genitalia of the different races vary in size but are similar in all other respects. Beyond India, the Chinese province of Yunnan in the extreme east of the Palaearctic region supports two divergent species, *M. yuenty* and *M. agar*, the latter extending into Tibet at high altitudes, with considerable racial variation. One other species inhabits the north of this inhospitable region, *M. romanovi*, about which there is little information.

#### Eastern Siberia, including N. China, Mongolia and N. Korea

Near Lake Baikal (100°E) the picture changes. While some of the western dominants are still to be found, more often their eastern ranges are continued by subspecies or closely related species across temperate Siberia, China and Mongolia to Korea and often to Japan. Six genera are present: *Melitaea*, with one species, *M. diamina protomedia*, Amur etc.; *Cinclidia*, with two species, *C. scotosia*, also in Mongolia and Japan, and *C. phoebe* whose range extends to N. China,

but probably it is not truly Siberian; *Didymaeformia* with two species, *D. didymoides*, Changai Mts, Kansu, Korea etc., and *D. sutschana*, Amur, Korea; *Mellicta* with five species, *M. athalia ambigua*, male genitalia with small subspecific characters, *M. britomartis amurensis*, Amur, Sutschan etc., *M. centralasiae*, Shigansk, Kentei Mts, Chingan Mts, etc.; *M. menetriesi*, Amur and Kamschatka, *M. plotina*, Ussuri, Amur (Bureja Mts), Transbaicalia (?). The known data of these species are not satisfactory, and it is not possible at present to record their individual ranges. Two other *Mellicta* species, *M. alatauca* and *M. rebeli*, from the Alatau and Altai Mts respectively, really belong to this group; as they are represented by only a few specimens, their true distribution is quite unknown. *Hypodryas*, with three species, *H. intermedia konumensis* from Sutschan and Korea, larger than western specimens, *H. iduna*, recorded from the far north, *H. maturna* recorded from S. and E. Siberia. *Eurodryas*, with one species, *E. aurinia siberica* from Transbaical, Mongolia, Kansu, Korea etc., very variable.

The generic list in E. Siberia closely resembles that of W. Europe. The genus *Cinclidia* is probably best regarded as Euro-Siberian. Five species are widely distributed in warm and temperate areas of the Palaearctic, as follows. *C. phoebe*: S. and C. Europe and eastwards to S. Siberia and N. China; *C. aetherie*: Morocco, Spain, Sicily; *C. sibina*: Turkestan, Thian Shan; *C. scotosia*: E. Siberia, N. China, Korea, Japan; *C. sarvistana*: S. Iran (Zagros Mts), very divergent. While the genus does not reach N. America, the *Chlosyne* series in the western mountains, by habitus and wing markings, appears more closely related to *Cinclidia* than to any other melitaeid genus.

#### NEARCTIC AND NEOTROPICAL REGIONS

There is no reason to suppose that the Eurasiatic continent has been other than a single united land mass throughout the development and dispersal of the present Melitaeine fauna. It is otherwise with the Americas. Across the Behring Straits North America has been connected many times with Asia. On the other hand, it has been separated by marine barriers from South America until junction occurred relatively recently in geological terms. The situation in Central America in the distant past appears to be uncertain, but the present Melitaeid fauna is distinctive. The Antillean archipelago, perhaps the remaining traces of a former continent, is still unconnected with the mainland. These archaic isolations of two, or perhaps three large continents, are reflected in the distribution and the character of the butterflies. With few exceptions the Palaearctic Melitaeine genera are absent from the American continents. An exception is *Hypodryas gillettii*, which occurs in the mountains of Wyoming and Montana, and is a close relative of the European *H. maturna*.

#### North America

The Euphydryini are well represented by four species of *Occidryas* in the western Mountains. These show great differentiation compared with the Eurasiatic series. *Hypodryas gillettii*, referred to above, is of great interest. It is the single representative within the subfamily of a truly Palaearctic Melitaeine genus present in America. *Euphydryas phaeton*, with eastern distribution, is not closely related to *Occidryas*. It is most divergent in wing markings, and the structure of the male genitalia suggests relationship to the European *Eurodryas aurinia*. The tribes Melitaeini and Phyciodini are both well represented, and again principally in the western areas and mountains, each with a single genus, *Chlosyne* and *Phyciodes* respectively. Although belonging to different tribes, the two genera have certain features in common in their American ranges. First, the genitalic characters and wing markings in each genus are almost identical in all species, so that generic identification is very easy but specific identification usually difficult. Secondly, all species of both genera have the common basic Melitaeine pattern of upperside wing markings, with black spots and striae on a fulvous ground. This pattern is rare further south, and almost non-existent south of Mexico. The situation is difficult to explain, since in both cases these northern populations probably represent dispersals from the more primitive populations in Central America (*Chlosyne*) and South America (*Phyciodes*). In both genera the almost complete lack of diversity in genitalia and in wing markings does not suggest an ancient origin. In North America there do not appear to be examples of the impressive specific disjunctions that are not uncommon in Eurasia, nor are there any isolated relict forms among the Melitaeinae. On the other hand

there are two unexpected continental disjunctions in *Hypodryas gillettii*, referred to above, and the Sonoran *Poladryas*, in my opinion a displaced Eurasiatic genus. Nor is there any basically allopatric Melitaeine group in North America; all genera are traceable to dispersal from neighbouring populations. The tropical region is usually considered to have its frontier in southern Mexico. Between this and Nearctic North America there is an important transitional area, continuous with the southern states of Arizona, Texas, New Mexico and S. California, forming the so-called Sonoran region. The situation here is exceptional, with vast areas of dry, semi-desert country and an interesting and individual butterfly fauna. Melitaeine butterflies in this region include the very small species of *Texola* and *Dymasia*, and *Thessalia leanira*, with its remarkable series of local forms or subspecies, each with rather grotesque facies and not obviously related to *Melitaea*. The structure of the genitalia in these interesting little species (valves with three terminal processes) shows them all to be members of the *Chlosyne* series, of which such tropical forms as *C. lacinia* and *C. janais* begin to appear. The Phyciodini are also well represented, especially species of the genus *Anthanassa*, very different taxonomically and in appearance from the typical *Phyciodes* that fly in North America.

#### *Central and South America*

These regions are taken together as their Melitaeine faunas are so similar. In Central America the genus *Chlosyne* attains its maximum tropical development with 16 species or more, in a compact group centred in Mexico and extending across Central America to Colombia and Venezuela. A single species, *C. lacinia*, with many confusing polymorphic forms, has extended its distribution northwards as an occasional migrant in the Sonoran region, and southwards to include Brazil and northern Argentina. This species is exceptional in showing normal family coloration of dark markings upon a fulvous ground in the local forms *californica* and *saundersi*, the latter widespread in many parts of South America, and treated with specific rank by many local entomologists. In Central and South America the Phyciodini, with 13 genera, is the dominant tribe, extending southwards to Bolivia and northern Argentina, forming the principal subject of this paper. Two small divergent genera, not members of the Phyciodini, occur in N. Peru, Bolivia and S. Colombia. Two of these, *Gnathotriche* and *Gnathotrusia*, are dealt with on pp. 160–163. Another genus, *Higginsius*, has a single species which flies in the same area, and appears equally out of place among the *Phyciodes* series. The genitalic characters and primitive type of wing venation suggest relationship with *Gnathotriche*, although the wing markings are quite different. In fact, in Central and South America, the very frequent modification of the wing markings to form cryptic or mimetic patterns has greatly reduced the taxonomic importance of wing markings in these Melitaeinae.

#### *The Antilles*

The subfamily is poorly represented with seven species, of which six are truly endemic, representing two, or perhaps three tribes. Of the two *Phyciodes* species, *P. phaon* is probably a recent introduction from the U.S.A., but the second, *P. frisia*, is endemic on each of the larger islands. The genus *Antillea*, with two very small species endemic on Jamaica, Cuba and Haiti, is probably best placed with *Melitaea*, but its characters are very divergent, and it is certainly unrelated to the American fauna. A third genus, *Atlantea*, is represented by a single species on each of the larger islands. The species are closely related to each other, but their characters, especially those of the females, are so unusual that I cannot place the genus in any tribal group. Satisfactory material, especially of the rare females, is not available for examination.

Considering the situation of these islands so close to mainland America, it is remarkable that there is so little evidence of relationship with the American Melitaeine fauna. The analysis suggests a highly individual fauna, distantly related to Europe.

### Acknowledgements

I have to record my grateful thanks to the Trustees of the British Museum (Natural History) for their permission to study the collections and for encouragement in the preparation of this review. I wish to thank Mr C. A. B. Steele, the Curator of the Booth Museum, Brighton,



Sussex, for permission to study the Hall collection of Phyciodini, and for allowing me to dissect several interesting specimens from this remarkable collection. I must record my special gratitude to my late friend Mr Norman Riley for many useful suggestions and for his help in settling many difficulties of nomenclature. Dr D. R. Ragge, Mr R. I. Vane-Wright, Mr W. G. Tremewan and Mrs R. Arora have given indispensable help, especially in editorial matters and in settling the arrangement of figures and text in the final stages. I owe several useful specimens to the kindness of Prof. Keith Brown, now working at the University of Campinas, São Paulo, Brazil, who has helped greatly with information about the habitats and distribution of Brazilian species.

## References

- Adams, M. J. & Bernard, G. I.** 1979. Pronophilinae butterflies (Satyridae) of the Serranía de Valledupar, Colombia—Venezuela border. *Syst. Ent.* **4**: 95–118.
- Aurivillius, P. O. C.** 1882. Recensio critica Lepidopterorum Musei Ludovicae Ulricaе. *K. svenska Vetensk Akad. Handl.* **19**(5): 1–188, 1 pl.
- Bargmann, R.** 1928. Neue exotische Falter. *Lepid. Rdsch.* **2**: 234–236.
- Barnes, W. M. & McDunnough, J.** 1917. *Check list of the Lepidoptera of boreal America*, ix + 392 pp. Decatur, Illinois.
- Bauer, D. L.** 1975. Tribe Melitaeini, pp. 139–195. In Howe, W. H. (ed.), *The butterflies of North America*, xiii + 633 pp., 97 pls. Garden City, New York.
- Bates, H. W.** 1864a. New species of butterflies from Guatemala and Panama, collected by Osbert Salvin and F. du Cane Godman, Esq. [part]. *Entomologist's mon. Mag.* **1**: 81–85.
- 1864b. Contributions to an insect fauna of the Amazon valley. Lepidoptera, Nymphalidae. [part]. *J. Ent. Lond.* **2**: 175–213.
- 1866. New species of butterflies from Guatemala and Panamá, Supplement. [part]. *Entomologist's mon. Mag.* **3**: 133–136.
- Behr, H.** 1863. On Californian Lepidoptera—no. III. *Proc. Calif. Acad. Sci.* **3**: 84–93.
- Bergsträsser, J. A. B.** 1780–1783. *Nomenclatur und Beschreibung der Insecten in der Grafschaft Hanau-Münzenberg* **4**, 48 pp., pls. (col., unnumbered). Hanau.
- Boisduval, J. B. A. D. de**, 1836. *Histoire naturelle des insectes. Species générale des Lépidoptères*. **1**: xii + 690 pp., 24 pls (forms part of Roret's *Suites à Buffon*). Paris.
- 1852. Lépidoptères de la Californie. *Annls Soc. ent. Fr.* (2) **10**: 275–324.
- 1869. Lépidoptères de la Californie. *Annls Soc. ent. Belg.* **12**: 5–28, 37–94.
- Boisduval, J. B. A. de & Leconte, J.** 1833. *Histoire générale et iconographie des Lépidoptères et des chenilles de l'Amérique septentrionale* [published 1829–1937], [iv] + 228 pp., 78 pls. Paris.
- Brehme, H. H.** 1913. A new aberration in *Phyciodes* (Lepid.). *Ent. News* **24**: 194, 1 pl.
- Brown, F. M.** 1966. The types of the nymphalid butterflies described by William Henry Edwards—part 2, Melitaeinae. *Trans. Am. ent. Soc.* **92**: 357–468.
- Bryk, F.** 1953. Lepidoptera aus dem Amazonasgebiete und aus Peru gesammelt von Dr. Douglas Melin und Dr. Abraham Roman. *Ark. Zool.* **5**: 1–268.
- Butler, A. G.** 1870. *Catalogue of diurnal Lepidoptera described by Fabricius in the collection of the British Museum*, v + 303 pp., 3 pls. London.
- 1872. Descriptions of new butterflies from Costa Rica. *Cistula ent.* **1**: 72–90.
- 1874. *Lepidoptera exotica, or descriptions and illustrations of exotic Lepidoptera* (publ. 1869–1874), iv + [ii] + 189 pp., 64 pls, + index [v]. London.
- 1877. List of Lepidoptera recently collected by Mr. Walter Davis in Peru, with descriptions of a new genus and several new species. *Ann. Mag. nat. Hist.* (4) **20**: 117–129.
- Butler, A. G. & Druce, H.** 1872. Descriptions of new genera and species of Lepidoptera from Costa Rica. *Cistula ent.* **1**: 95–118.
- Chapman, T. A.** 1913. Mimicry (?) in *Erebia*s. *Proc. ent. Soc. Lond.* **1913**: cvii–cx.
- Clerck, C. A.** 1764. *Icones insectorum rariorum* (2), [8 + 3 pp.], 16 pls. Holmiae.
- Cockerell, T. D. A.** 1913. Two new varieties of *Phyciodes camillus*, Edwards. *Entomologist* **46**: 308–309.
- Comstock, J. A.** 1927. *Butterflies of California*, 334 pp., 63 pls. Los Angeles.
- Cramer, P.** [1775–6]. *De Uitlandsche Kapellen voorkomende in de drie waerelddeelen Asia, Africa en America* **1**: 2 frontispieces, [vi + xxx + 161 + 55 pp.], pls 1–96. Amsteldam & Utrecht.
- [1777]. *De Uitlandsche Kapellen . . . 2*, 151 pp., pls 97–192. Amsteldam & Utrecht.
- [1779–80]. *De Uitlandsche Kapellen . . . 3*, 176 pp., pls 193–288. Amsteldam & Utrecht.

- [1780]. *De Uitlandsche Kapellen* . . . 4 part, pp. 1–28, pls 289–304 [vol. 4 completed by C. Stoll]. Amsterdam & Utrecht.
- de Freina, J. J.** 1980. *Melitaea tangigharuensis* n. sp., eine neue Nymphalidenart für Afghanistan nebst vergleichender Betrachtung zur *M. sarvistana* Wiltshire, 1941 (Lepidoptera, Nymphalidae). *Atalanta, Münsterstadt* 11: 11–18, figs 1–9.
- de la Maza, R.** 1978. Una nueva especie del genero *Phyciodes* Hübner de Mexico (Nymphalidae). *Revta Soc. Mex. Lepid.* 4: 39–44, back cover.
- Dognin, P.** 1887. Notice sur la faune des Lépidoptères de Loja et environs (Équateur) et descriptions d'espèces nouvelles. *Naturaliste* (2) 9: 172–175, 188–190.
- 1888. Diagnoses de Lépidoptères nouveaux de l'Équateur. *Naturaliste* (2) 10: 48, 67–68.
- 1894. Lépidoptères nouveaux de Loja et environ. *Anns. Soc. ent. Belg.* 38: 680–687.
- dos Passos, C. F.** 1935. Some butterflies of southern Newfoundland with descriptions of new subspecies (Lepid. Rhopal.). *Can. Ent.* 67: 82–88.
- 1964. A synonymic list of the Nearctic Lepidoptera. *Mem. Lepid. Soc.* (1): v + 145 pp.
- Doubleday, E.** [1846–1849]. In Doubleday, E. & Westwood, J. O., *The genera of diurnal Lepidoptera*, 1: 250 pp., 33 pls. London.
- Druce, H.** 1874a. Descriptions of fifteen new species of diurnal Lepidoptera, chiefly from South America. *Trans. ent. Soc. Lond.* 1874: 155–160.
- 1874b. Descriptions of three new butterflies from Costa Rica. *Entomologist's mon. Mag.* 11: 36–37.
- 1876. List of the butterflies of Peru, with descriptions of new species. With some notes by Edward Bartlett. *Proc. zool. Soc. Lond.* 1876: 205–250, 2 pls.
- Drury, D.** [1770/1773]. Illustrations of natural history, xxviii + 130 pp., 50 pls; index, errata and addenda (including names for species depicted in vol. 1) published in 1773, with vol. 2 of this work. London.
- Dyar, H. G.** 1913a. Descriptions of new Lepidoptera, chiefly from Mexico. *Proc. U.S. natn. Mus.* 44: 279–324.
- 1913b. Results of the Yale Peruvian Expedition of 1911. Lepidoptera. *Proc. U.S. natn. Mus.* 45: 627–649.
- Edwards, W. H.** 1861. Descriptions of certain species of diurnal Lepidoptera, found within the limits of the United States and of British America. *Proc. Acad. nat. Sci. Philad.* 1861: 160–164.
- 1863. Descriptions of certain species of diurnal Lepidoptera found within the limits of the United States and British America. No. 2. *Proc. ent. Soc. Philad.* 2: 78–82.
- 1864. Descriptions of certain species of diurnal Lepidoptera found within the limits of the United States and British North America, no. 3. *Proc. ent. Soc. Philad.* 2: 501–507.
- 1865. Descriptions of certain species of diurnal Lepidoptera found within the limits of the United States and British America, no. 4. *Proc. ent. Soc. Philad.* 4: 201–204.
- [1869]. Notes on a remarkable variety of *Papilio turnus*, and descriptions of two species of diurnal Lepidoptera. *Trans. Am. ent. Soc.* 2: 207–210.
- 1869. Descriptions of new species of diurnal Lepidoptera found within the United States. *Trans. Am. ent. Soc.* 2: 369–376.
- 1871a. Descriptions of new species of diurnal Lepidoptera found within the United States. *Trans. Am. ent. Soc.* 3: 205–216.
- 1871b. Descriptions of new species of North American butterflies. *Trans. Am. ent. Soc.* 3: 266–277.
- 1871c. Descriptions of new North American diurnal Lepidoptera. *Trans. Am. ent. Soc.* 3: 189–196.
- 1878. *The butterflies of North America* 2 (7): *Phyciodes* 2, [4], 1 pl. Boston.
- Erschoff, N.** 1874. Description of new species of exotic Lepidoptera. *Trud̄y. russk. ent. Obshch.* 8: 140–149, 1 pl.
- Eschscholtz, J. F.** 1821. Beschreibung neuer ausländischer Schmetterling. In Kotzebue, O. von, *Entdeckungs-Reise in die Süd-See und nach der Berings-Strasse zur Erforschung einer nord östlichen Durchfahrt*, 3 Appendix (5): 201–219, 11 pls. Weimar.
- Fabricius, J. C.** 1775. *Systema entomologiae*, [xxxii] + 832 pp. Flensburgi et Lipsiae.
- 1781. *Species insectorum*, 2: 517 pp. Hamburgi & Kilonii.
- 1787. *Mantissa insectorum*, 2: 382 pp. Hafniae.
- 1807. *Systema Glossatorum*. Die neueste Gattungs-Eintheilung der Schmetterlinge aus den Linnéischen Gattungen *Papilio* und *Sphinx*. *Magazin Insektenk.* (Illiger) 6: 277–295.
- Fassl, A. H.** 1912. Neue Nymphaliden aus Südamerika. *Ent. Rdsch.* 29: 121–123.
- 1922. Neue Schmetterlingsformen aus Brasilien [part]. *Ent. Z., Frankf. a.M.* 36: 38–39.
- Felder, C. & Felder, R.** 1861. Lepidoptera nova Columbiae [part]. *Wien. ent. Monatschr.* 5: 97–111.
- 1862a. Specimen faunae lepidopterologicae riparum fluminis Negro superioris in Brasilia septentrionali [part]. *Wien. ent. Monatschr.* 6: 109–126.

- 1862b. *Lepidoptera nova Columbiae. Series tertia. Wien. ent. Monatschr.* 6: 409–427.
- 1865–1867. *Reise der Österreichischen fregatte Novara. Zoologischer Theil, Zweiter Band, Zweite Abteilung, Lepidoptera, Rhopalocera.* vi + 535 pp., 74 pls. Wien.
- Felder, R.** 1869. Diagnosen neuer von dem K. K. Oberlieutenant H. v. Hedemann in Mexico in den Jahren 1865–1867 gesammelter Lepidopteren. Erste Folge. *Verh. zool.-bot. Ges. Wien* 19: 465–480.
- Fender, K. M.** 1930. A new butterfly aberration (Lepid.: Nymphalidae). *Ent. News* 41: 182.
- Ferreira d'Almeida, R.** 1922. *Mélanges Lépidoptérologiques. Études sur les Lépidoptères du Brésil*, viii + 226 pp. Berlin.
- Forbes, W. T. M.** 1945. The genus *Phyciodes* (Lepidoptera, Nymphalinae). *Entomologica am.* 24: 139–207.
- 1946. The genus *Gnathotriche* (Lepidoptera, Nymphalidae), pp. 195–198 (no. 18). In *Livro de homenagem a R. Ferreira d'Almeida*. Sao Paulo.
- Gabriel, A. G.** 1927. *Catalogue of the type specimens of Lepidoptera Rhopalocera in the British Museum.* Part III. Nymphalidae. 128 pp. London.
- Geyer, C.** 1832. *Zuträge zur Sammlung exotischer Schmetterlinge.* 48 pp., 33 pls. Augsburg.
- Giacomelli, E.** 1911. Lepidópteros riojanos nuevos ó poco conocidos. *An. Soc. cient. argent.* 72: 19–26.
- 1928. Nuevos lepidópteros de Cosquín. *Bol. Inst. Clin. quirurg.* 4: 677–690.
- Godart, J. B.** 1819, 1824. In Latreille, P. A. & Godart, J. B., *Encyclopédie méthodique. Histoire Naturelle [Zoologie]* 9. Entomologie. [iv] + 828 pp. Paris.
- Godman, F. du C. & Salvin, O.** 1878a. Descriptions of nineteen new species of diurnal Lepidoptera from Central America. *Proc. zool. Soc. Lond.* 1878: 264–271.
- 1878b. Descriptions of new species of Rhopalocera from Central and South America. *Ann. Mag. nat. Hist.* (5) 2: 257–266.
- 1879. Descriptions of new species of Rhopalocera from Central and South America. *Proc. zool. Soc. Lond.* 1879: 150–155, 1 pl.
- 1880. A list of the diurnal Lepidoptera collected in the Sierra Nevada of Santa Marta, Colombia, and the vicinity. *Trans. ent. Soc. Lond.* 1880: 119–132, 2 pls.
- 1882. *Biologia Centrali-Americana. Insecta, Lepidoptera-Rhopalocera* 1, 487 pp., 48 pls [1879–1886].
- 1889. Descriptions of new species of Rhopalocera from Mexico and Central America. *Ann. Mag. nat. Hist.* (6) 3: 351–358.
- 1897. Descriptions of new species of Central and South American Rhopalocera. *Trans. ent. Soc. Lond.* 1897: 241–248.
- 1901. *Biologia Centrali-Americana. Insecta, Lepidoptera-Rhopalocera* 2, 782 pp., pls 84–112 [1887–1901].
- Grimshaw, P. H.** 1898. On some type specimens of Lepidoptera and Coleoptera in the Edinburgh Museum of Science and Art. *Trans. R. Soc. Edinb.* 39: 1–11, 1 pl.
- Gunder, J. D.** 1927. New transition forms or 'abs' and their classification (Lepid., Rhopalocera). *Ent. News* 38: 129–138, 1 pl.
- 1928. Additional transition forms (Lepid., Rhopalocera). *Can. Ent.* 60: 162–168, 2 pls.
- 1930. Butterflies of Los Angeles County, California. *Bull. Sth. Calif. Acad. Sci.* 29: 39–95, 'frontispiece', map. [Also appeared as 'unauthorised separate', 6.viii.1930; see Editor's note, p. 95.]
- 1932. New Rhopalocera (Lepidoptera). *Can. Ent.* 64: 276–284.
- Guppy, R.** 1974. *Phyciodes mylitta* (Nymphalidae) on Vancouver Island. *J. Lepid. Soc.* 28: 223.
- Hall, A.** 1977. New butterflies of the family Nymphalidae. [part]. *Entomologist* 50: 161–163.
- 1921. Descriptions of three new butterflies from Colombia. *Entomologist* 54: 278–279.
- 1928a. Some new forms of Nymphalinae (Rhopalocera) from tropical America. *Entomologist* 61: 11–13.
- 1928b–1930. A revision of the genus *Phyciodes* Hubn. (Lepidoptera Nymphalidae). *Bull. Hill. Mus., Witley* (as supplements to vols 2–4), pp. 1–44, 2 pls (1928), 45–170 (1929), 171–204 + additions [205] (1930).
- 1935. New forms of Nymphalinae and Ithomiinae. *Entomologist* 68: 221–227, 1 pl.
- Hall, G. C.** 1924. Notes on *Polygonia j-album*, *Cercyonis alope*, *Phyciodes tharos*, *Heodes epixanthe* and *Euphydryas gilletti*. *Jl. N. Y. ent. Soc.* 32: 109–111, 1 pl.
- Harris, W. T.** 1862. *A treatise on some of the insects injurious to vegetation* (3rd edn), xi + 640 pp., 8 pls. Boston.
- Hayward, K. J.** 1931. Lepidópteros Argentinos. Fámilia Nymphalidae. *Revta Soc. ent. argent.* 4: 1–199, 21 pls.
- 1933. Notas adicionales acerca de los Nymphalidae Argentinos. *Revta Soc. ent. argent.* 5: 213–218.
- 1935. *Phyciodes liriopae* (Cramer) (Lep. Nymph.) sinonimia y distribución, especialmente de formas Argentinas. *Revta Soc. ent. argent.* 7: 219–223.

- 1949. *Ninfalidos argentinos: modificaciones en su nomenclatura y en la lista de especies* (Lep. Nymphalidae). *Acta zool. lilloana* 7: 5–26.
- 1952. Más notas sobre Ninfalidos Argentinos. *Acta zool. lilloana* 10: 285–290.
- 1964a. Una nueva *Phyciodes* de Peru (Lep. Rhop. Nymphalidae). *Acta zool. lilloana* 20: 63–65.
- 1964b. Nymphalidae. *Genera et species animalium argentinorum*, 3: [ix] + 472 pp., 20 pls.
- 1967. Una nueva *Phyciodes* del Ecuador Oriente (Lep. Rhop. Nymphalidae). *Acta zool. lilloana* 21: 13–15.
- Hemming, F.** 1937. *Hübner* 1: frontispiece, xxxiv + 605 pp.; 2: xii + 274 pp. London.
- 1964. *Annotationes Lepidopterologicae* 4: 115–154. London.
- Hering, M. & Hopp, W.** 1925. Eine Sammelausbeute des Herrn Werner Hopp aus dem Chocó Kolumbiens. *Dt. ent. Z. Iris* 39: 181–207.
- Hewitson, W. C.** [1852]. *Illustrations of new species of exotic butterflies, selected chiefly from the collections of W. Wilson Saunders and William C. Hewitson* 1: v + [120 pp.] + index [iv] + [60] pls. London.
- [1857]. *Illustrations of . . . exotic butterflies . . .* 2: iv + [120 pp.] + index [iv] + [60] pls. London.
- [1864; 1866]. *Illustrations of . . . exotic butterflies . . .* 3: iv + [120 pp.] + index [iv] + [60] pls. London.
- [1868; 1870]. *Illustrations of . . . exotic butterflies . . .* 4: iii + [114 pp.] + index [iv] + [60] pls. London.
- 1869a. *Equatorial Lepidoptera collected by Mr Buckley* (1): ii + 16 pp.; (2): pp. 17–32. London.
- 1869b. Descriptions of six new species of diurnal Lepidoptera from Nicaragua. *Trans. ent. Soc. Lond.* 1869: 33–35.
- 1869c. Descriptions of new species of Lepidoptera Rhopalocera, from Old Calabar and Ecuador. *Entomologist's mon. Mag.* 6: 97–99.
- [1872]. *Illustrations of . . . exotic butterflies . . .* 5: iii + [116 pp.] + index [v] + preface [ii] + systematic index for whole work [v]. London.
- 1874a. *Descriptions of new species of butterflies collected by Mr. Buckley in Bolivia*. 22 pp. London.
- 1874b. Descriptions of new species of butterflies. *Entomologist's mon. Mag.* 11: 56.
- Higgins, L. G.** 1930. Some erebiid butterflies from Styria. *Proc. ent. Soc. Lond.* 5: 21.
- 1941. An illustrated catalogue of the palearctic *Melitaea* (Lep. Rhopalocera). *Trans. R. ent. Soc. Lond.* 91: 175–365, 16 pls.
- 1950. A descriptive catalogue of the palaeartic *Euphydryas* (Lepidoptera: Rhopalocera). *Trans. R. ent. Soc. Lond.* 101: 435–489.
- 1955. A descriptive catalogue of the genus *Mellicta* Billberg (Lepidoptera: Nymphalidae) and its species, with supplementary notes on the genera *Melitaea* and *Euphydryas*. *Trans. R. ent. Soc. Lond.* 106: 1–132, 2 pls.
- [1959]. Four new Melitaeine genera (Nymphalidae). *Lepid. News* 12 (1958): 161–164.
- 1960. A revision of the Melitaeine genus *Chlosyne* and allied species (Lepidoptera: Nymphalinae). *Trans. R. ent. Soc. Lond.* 112: 381–467.
- 1978. A revision of the genus *Euphydryas* Scudder (Lepidoptera: Nymphalidae). *Entomologist's Gaz.* 29: 109–115.
- Holland, W. J.** 1947. *The butterfly book* [new and thoroughly revised edn], xii + 424 pp., 77 pls. Garden City, New York.
- Hopffer, C.** 1874. Neue Lepidopteren von Peru und Bolivia. *Stettin. ent. Ztg.* 35: 329–371.
- Howe, W. H.** 1975. *The butterflies of North America*, xiii + 633 pp., 97 pls. Garden City, New York.
- Hübner, J.** [1807, 1808]. *Sammlung exotischer Schmetterlinge* 1: title page, [36] + [iv] pp., 213 col. pls. [published [1806]–[1832]]. Augsburg.
- [1816, 1819]. *Verzeichniss bekannter Schmettlinge*. 431 + 72 pp. [published 1816–[1826]]. Augsburg.
- 1823. *Zuträge zur Sammlung exotischer Schmettlinge* 2: [3] + 4–6 + [7] + 8–32 + [33]–[40] pp., col. pls [36]–[69] (figs 201–400) [published [1819]–1823]. Augsburg.
- [—] [1825]. *Catalogue des Lépidoptères qui composent la collection de feu Mr Franck*, [iv] + 108 pp. Strasbourg.
- [1826]. *Sammlung exotischer Schmetterlinge* 2: Title page + [iv] pp., 225 pls. [publ. [1819]–[1832]]. Augsburg.
- Kirby, W.** 1837. The Insects. In Richardson, J., (ed.), *Fauna Boreali-Americana or the Zoology of the northern parts of British America*, xxxvii + 325 pp., 8 pls, errata [i]. London.
- Kirby, W. F.** 1871. *A synonymic catalogue of diurnal Lepidoptera*, viii + 690 pp. London.
- 1900. Additional notes. In Wytzman, P., *Sammlung exotischer Schmetterlinge* (by Jacob Hübner), new English Fac-simile edition, [i] + 172 pp. Brussels.
- Klots, A. B.** 1951. *A field guide to the butterflies of North America, east of the Great Plains*, xvi + 349 pp., 40 pls. Boston.
- Köhler, P.** 1945. Melanismos naturales en Lepidopteros Argentinos. *Revta Soc. ent. argent.* 12: 253–256, 1 pl.

- Kollar, V.** [1849]. Beiträge zur Insecten-Fauna von Neu-Granada und Venezuela. *Denkschr. Akad. Wiss. Wien* 1: 351–364, 4 pls.
- Linnaeus, C.** 1758. *Systema naturae* (10th edn), [iv] + 824 pp. Holmiae.  
— 1767. *Systema naturae* 1 (2), 12th edn, pp. 533–1328 + [36]. Holmiae.
- Merian, M. S.** 1705. *Metamorphosis insectorum Surinamensium*, [iv] + 60 pp., 60 pls. Amstelodami.
- Moulton, J. C.** 1909. The collections of William John Burchell, D. C. L., in the Hope Department, Oxford University Museum. IV. On the Lepidoptera Rhopalocera collected by W. J. Burchell in Brazil, 1825–1830 [part]. *Ann. Mag. nat. Hist.* (8) 3: 98–111.
- Oberthür, C.** 1914. Les Lépidoptères de la Californie, par le docteur Boisduval. *Etudes de Lépidoptérologie Comparée* 9: 73–89, 7 pls. Rennes.
- Oliver, C. G.** 1978a. A male-lethal genetic factor in *Phyciodes tharos* (Nymphalidae). *J. Lepid. Soc.* 32: 231–233.  
— 1978b. Experimental hybridization between the nymphalid butterflies *Phyciodes tharos* and *P. campestris montana*. *Evolution* 32: 594–601.  
— 1979. Experimental hybridization between *Phyciodes tharos* and *P. batesii* (Nymphalidae). *J. Lepid. Soc.* 33: 6–20.
- Packard, A. S.** 1868 (1889). *Guide to the study of insects* (9th edn only consulted; 1st edn dated 1868–9), xii + 715 pp., 15 pls.
- Poey, P. H.** 1832. *Centurie de lépidoptères de l'île de Cuba*. Paris.
- Reakirt, T.** 1865. Descriptions of some new species of *Eresia*. *Proc. ent. Soc. Philad.* 5: 224–227.  
— 1866a. Coloradian butterflies. *Proc. ent. Soc. Philad.* 6: 122–151.  
— 1866b. Descriptions of some new species of diurnal Lepidoptera. *Proc. ent. Soc. Philad.* 6: 331–342.
- Reiff, W.** 1913. Some new forms of Lepidoptera from Massachusetts. *Ent. News* 24: 305–310, 1 pl.
- Riley, N. D.** 1975. *A field guide to the butterflies of the West Indies*, 224 pp. + 24 pls, endpapers. London.
- Röber, J.** 1913–1914. Genus *Phyciodes* Hbn. In Seitz, A., (ed.), *Gross-Schmetterl. Erde* (2) 5: pp. 434–448 (1913), 449–450 (1914); 5 pls.  
— 1924. [Additional notes]. In Seitz, A., (ed.), *Gross-Schmetterl. Erde* (2) 5: p. 1030, pl. 192.  
— 1927. Neue exotischer Falter. *Int. ent. Z.* 21: 97–100.
- Robson, G. C. & Richards, O. W.** 1936. *The variation of animals in nature*, xvi + 425 pp., 2 pls. London.
- Rosenberg, W. F. H. & Talbot, G.** 1914. New South American butterflies. *Trans. ent. Soc. Lond.* 1913: 671–682.
- Salvin, O.** 1869. Descriptions of new species of butterflies from tropical America. [part]. *Ann. Mag. nat. Hist.* (4) 4: 163–181.  
— 1871. Descriptions of new species of butterflies from tropical America. [part]. *Ann. Mag. nat. Hist.* (4) 7: 412–416.
- Salvin, O. & Godman, F. du C.** 1868. On some new species of diurnal Lepidoptera from South America. *Ann. Mag. nat. Hist.* (4) 2: 141–152.
- Schatz, E.** (1885)–1892. Die Familien und Gattungen der Tagfalter. In Staudinger, O. & Schatz, E., *Exotische Schmetterlinge*, 2: [vi] + II + 284 pp., 50 pls. Fürth, Bavaria.
- Schaus, W.** 1902. Descriptions of new American butterflies. *Proc. U.S. natn. Mus.* 24: 383–460.  
— 1913. New species of Rhopalocera from Costa Rica. *Proc. zool. Soc. Lond.* 1913: 339–367, 5 pls.
- Scott, J. A.** 1974. Early stages and biology of *Phyciodes orseis* (Nymphalidae). *J. Res. Lepid.* 12: 236–242.
- Scudder, S.** 1875. Synonymic list of the butterflies of North America, north of Mexico. *Bull. Buff. Soc. nat. Sci.* 2: 233–269.
- Shepard, J. H.** 1977. Immigration of *Phyciodes mylitta* to Vancouver Island (Lepidoptera: Nymphalidae). *Pan-Pacif. Ent.* 53: 167–168.
- Skinner, H.** 1897. Notes on Rhopalocera, with descriptions of new species and varieties. *Can. Ent.* 29: 154–156.  
— 1911. New species or sub-species of North American butterflies (Lepid.). *Ent. News* 22: 412–413.  
— 1917. New species of Lepidoptera. *Ent. News* 28: 328–329.
- Staudinger, O.** 1885 (1884–1888). *Exotische Tagfalter*, Band 1: Beschreibungen, Band 2: Abbildungen. [iv] + 333 pp., 100 pls. In Staudinger, O. & Schatz, E., *Exotische Schmetterlinge*. Bayern.  
— 1894. Hochandine Lepidoptera. *Dt. ent. Z. Iris* 7: 43–100, 2 pls.
- Strand, E.** 1912a. Exotisch-Lepidopterologisches. *Arch. Naturgesch.* 78(A) 9: 143–158.  
— 1912b. Über einige exotische Lepidoptera aus der Sammlung des Herrn W. Niepelt in Zirlau. *Arch. Naturgesch.* 78(A) 9: 178–186.  
— 1916. *Lepidoptera Niepeltiana* 2: 26 pp., 5 pls. Zirlau.  
— 1920. Bemerkungen über einige exotische Grossschmetterlinge [part]. *Int. ent. Z.* 14: 145–150.

- Tilden, J. W.** [1970]. Concerning the names and status of certain North American members of the genus *Phyciodes*. *J. Res. Lepid.* **8** (1969): 94-98.
- 1975. An analysis of the W. G. Wright butterfly and skipper plesiotypes in the collection of the California Academy of Sciences. *Occ. pap. Calif. Acad. Sci.* (118): 1-44.
- Vane-Wright, R. I.** 1975. The butterflies named by J. F. Gmelin (Lepidoptera: Rhopalocera). *Bull. Br. Mus. nat. Hist. (Ent.)* **32**: 17-64, 6 pls.
- 1976. A unified classification of mimetic resemblances. *Biol. J. Linn. Soc.* **8**: 25-56.
- van Someren, V. G. L. & Jackson, T. H. E.** 1959. Some comments on protective resemblance amongst African Lepidoptera (Rhopalocera). *J. Lepid. Soc.* **13**: 121-150.
- Vawter, A. T. & Brussard, P. F.** 1975. Genetic stability of populations of *Phyciodes tharos* (Nymphalidae: Melitaeinae). *J. Lepid. Soc.* **29**: 15-23.
- Weeks, A. G.** 1901. Description of nine new Bolivian butterflies. *Trans. am. ent. Soc.* **27**: 353-360.
- 1905. *Illustrations of diurnal Lepidoptera, with descriptions*, [1]: xii + 117 pp., 45 pls. Boston.
- 1906. New species of butterflies. *Ent. News* **17**: 195-204.
- 1911. *Illustrations of diurnal Lepidoptera, with descriptions*, 2: xvi + 37 pp., 21 pls. Boston.
- Weymer, G.** 1890. In Weymer, G. & Maassen, P., *Lepidoptera gesammelt auf einer Reise durch Colombia, Ecuador, Peru, Brasilien, Argentinien und Bolivien in den Jahren 1868-1877 von Alphons Stübel*, xi + 182 pp., 9 pls. Berlin.
- 1907. Exotische Lepidopteren. *Dt. ent. Z. Iris* **20**: 1-51, 2 pls.
- Wright, W. G.** 1906. *The butterflies of the west coast of the United States* (2nd edn; most of 1st edn, published in 1905, destroyed by fire), 257 + vii pp., frontispiece + 32 pls. San Bernardino.
- Young, A. M.** 1973. Notes on the biology of *Phyciodes (Eresia) eutropia* (Lepidoptera: Nymphalidae) in a Costa Rican mountain forest. *Jl N. Y. ent. Soc.* **81**: 87-100.
- Zikan, J. F.** 1937. Neue Nymphaliden-Arten und -Formen aus Brasilien. [part]. *Ent. Rdsch.* **54**: 385-387.
- Zimsen, E.** 1964. *The type material of I. C. Fabricius*, 656 pp. Copenhagen.

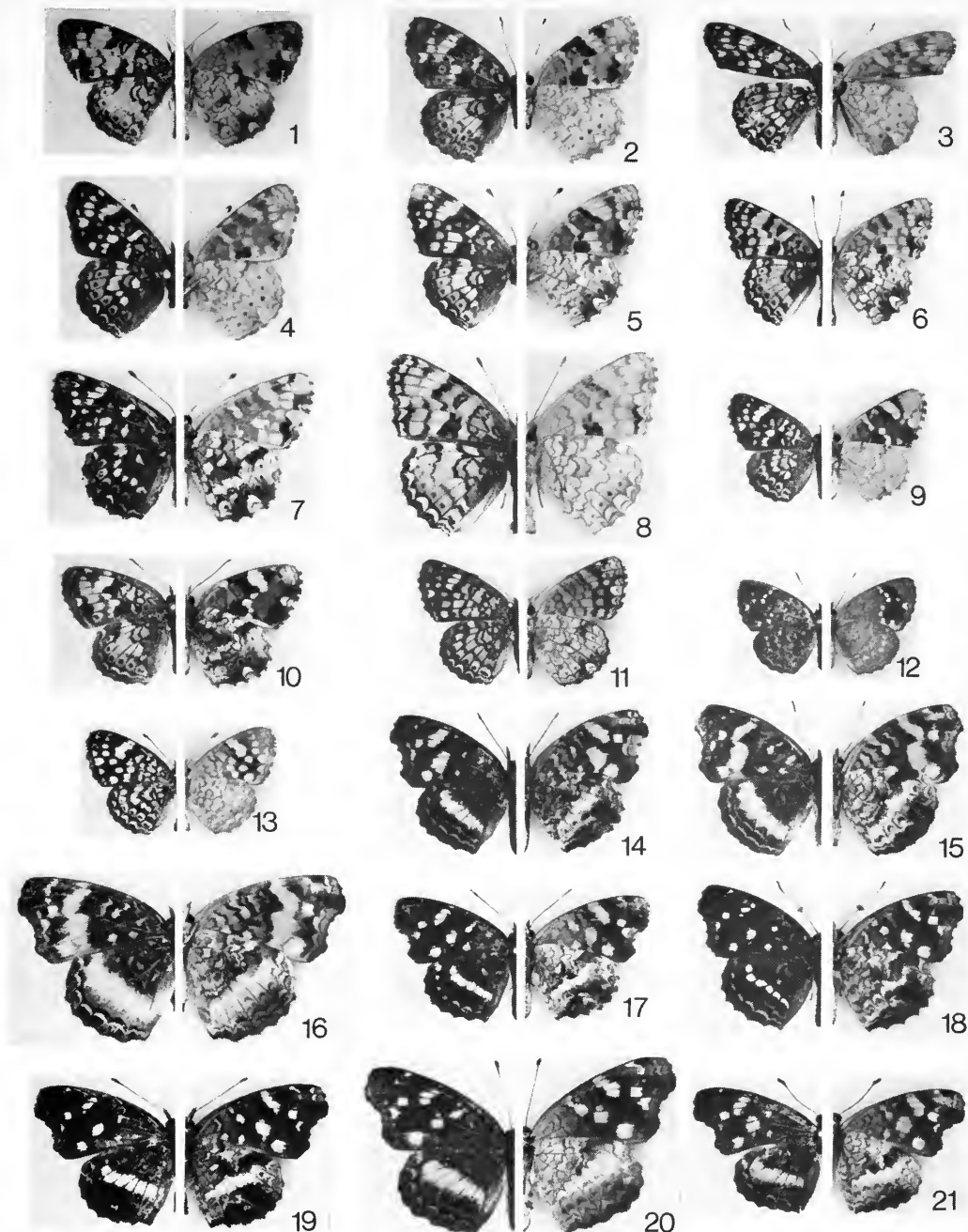

**Figs 1–21** 1–11, *Phyciodes* species. (1) *P. tharos* (Drury), Scranton, Pennsylvania; (2) *P. batesii* (Reakirt), Scranton, Pennsylvania; (3) *P. montanus* (Behr), Reno, Nevada; (4) *P. campestris campestris* (Behr), Sherman Camp, Oregon; (5) *P. campestris camillus* Edwards, Divide, Colorado; (6) *P. mylitta mylitta* (Edwards), Crater Lake, Oregon; (7) *P. mylitta thebais* (Godman & Salvin), Calderas, Guatemala; (8) *P. pallidus* (Edwards), Warm Springs, Jefferson County; (9) *P. pictus pictus* (Edwards), Arizona; (10) *P. phaon* (Edwards), Louisiana; (11) *P. vesta vesta* (Edwards), Bexar County, Texas. 12, 13, *Phystis* species. (12) *P. simois simois* (Hewitson), San Antonio da Barra, Bahia, Brazil; (13) *P. simois variegata* (Röber), Santiago de Chaquitos, Bolivia. 14–21, *Anthanassa* species. (14) *A. drusilla drusilla* (Felder & Felder), Merida, Venezuela; (15) *A. drusilla alceta* (Hewitson), Chanchamayo, Peru; (16) *A. drusilla verena* (Hewitson), Cochabamba, Bolivia; (17) *A. ptolyca ptolyca* (Bates), San Geronimo, Guatemala; (18) *A. ardys ardys* (Hewitson), Cordoba, Mexico; (19) *A. ardys subota* (Godman & Salvin), Vera Paz, Guatemala; (20) *A. dracaena* (Felder & Felder), 'New Granada' [Colombia]; (21) *A. phleaias* (Godman & Salvin), Honduras.



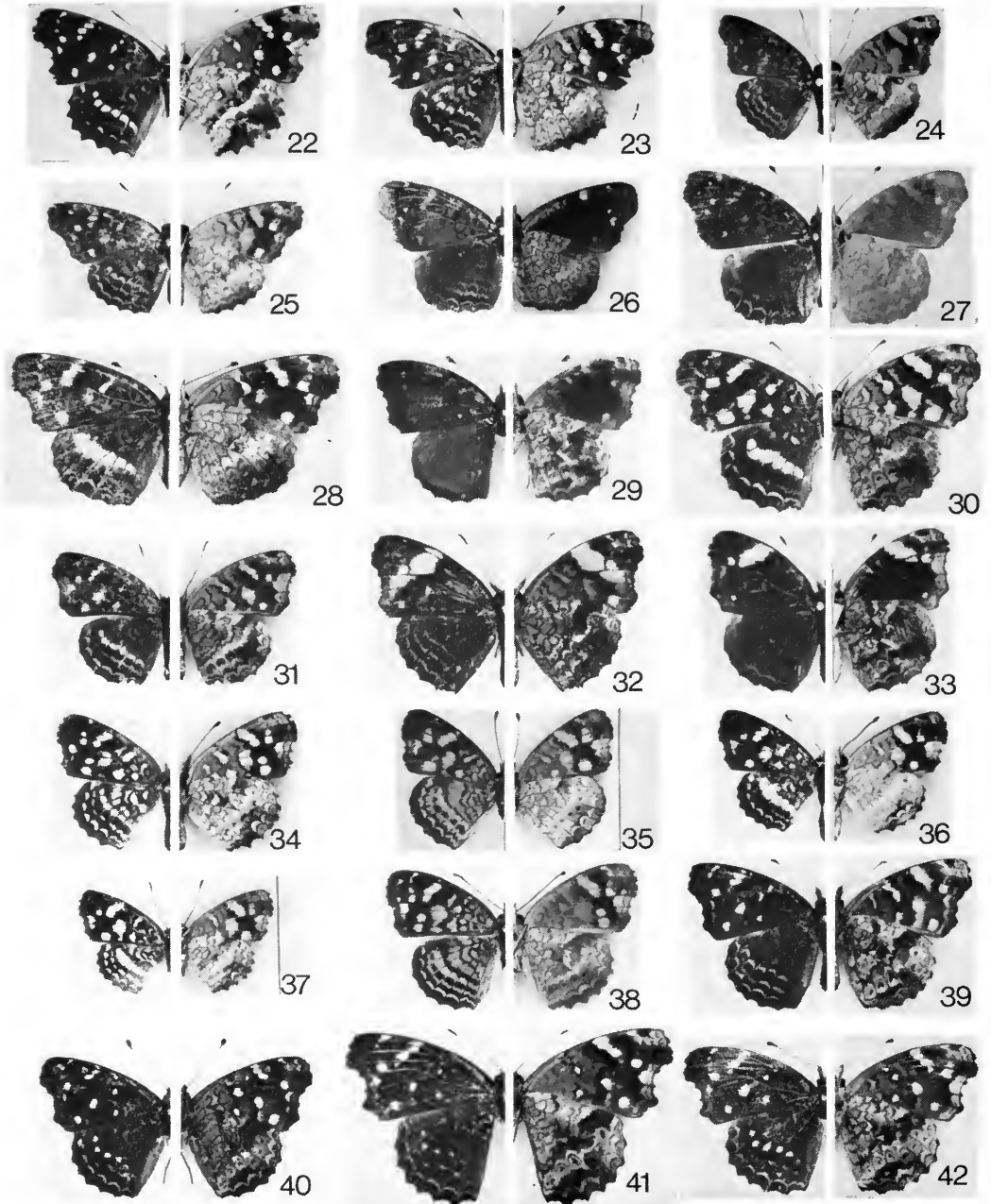

**Figs 22–42** *Anthanassa* species. (22) *A. texana texana* (Edwards), Sonora, Mexico; (23) *A. alexon alexon* (Godman & Salvin), Guerrero, Mexico; (24) *A. acesas* (Hewitson), Venezuela; (25) *A. nebulosa* (Godman & Salvin), Manaure, N. Colombia; (26) *A. argentea* (Godman & Salvin), Atoyac, Vera Cruz, Mexico; (27) *A. atronia* (Bates) ♂, Zapoto, Guatemala; (28) *A. atronia* (Bates) ♀, Atoyac, Vera Cruz, Mexico; (29) *A. otones otones* (Hewitson) ♂, Duenas, Guatemala; (30) *A. otones otones* (Hewitson) ♀, Christobal, Vera Paz, Guatemala; (31) *A. annulata* sp. n., Rio Dagua, Colombia; (32) *A. crithona* (Salvin), Chiriqui, Panama; (33) *A. fulviplaga* (Butler), Cache, Costa Rica; (34) *A. hermas* (Hewitson), Sapucay, Paraguay; (35) *A. frisia* (Poey), Holgunin, Cuba; (36) *A. tulcis* (Bates), Yucatan, Mexico; (37) *A. dubia* (Hall), San Esteban, Venezuela; (38) *A. taeniata* (Röber), Vina, N. W. Peru; (39) *A. sosis* (Godman & Salvin), Irazu, Costa Rica; (40) *A. drymaea* (Godman & Salvin), Calderas, Guatemala; (41) *A. sitalces* (Godman & Salvin), Chilasco, Guatemala; (42) *A. cortes* (Hall), Omilteme, Guerrero, Mexico.



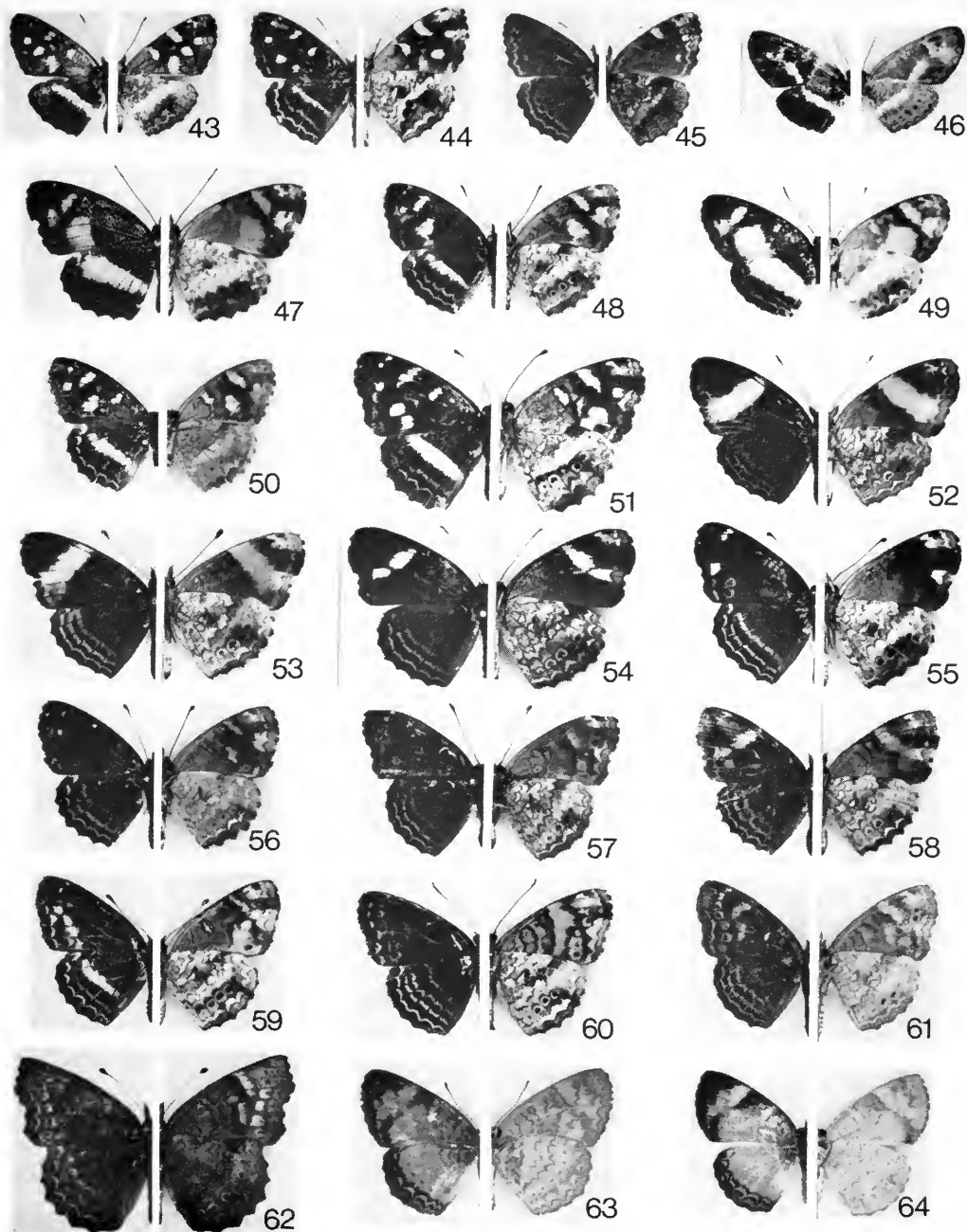

**Figs 43–64** 43–46, *Dagon* species. (43) *D. pusillus* (Salvin), Rio Colorado, Peru; (44) *D. catula* (Hopffer), Charaplaya, Bolivia; (45) *D. morenus* (Röber), Cuzco, Peru; (46) *D. fontus* (Hall), Guyana. 47–62, *Telenassa* species. (47) *T. teletusa* (Godart), Novo Friburgo, Brazil; (48) *T. berenice* (Felder & Felder), Chanchamayo, Peru; (49) *T. burchelli* (Moulton), Chanchamayo, Peru; (50) *T. signata* (Hall), La Rioja, Argentina; (51) *T. abas* (Hewitson), Siato, W. Colombia; (52) *T. jana* (Felder & Felder), Moyobamba, Peru; (53) *T. elaphina* (Röber), Cochabamba, Bolivia; (54) *T. nana* (Druce), Rio Colorado, Peru; (55) *T. nussia* (Druce), Chachapoyas, Peru; (56) *T. notus* (Hall), Pozuzo, Peru; (57) *T. gaujoni* (Dognin), Ecuador; (58) *T. trimaculata* (Hewitson), Ecuador; (59) *T. flavocincta* (Dognin), Chachapoyas, Peru; (60) *T. catenaria* (Godman & Salvin), W. Colombia; (61) *T. delphia* (Felder & Felder), Magdalena Valley, Colombia; (62) *T. sepulta* (Hall), Chachapoyas, Peru. 63, 64, *Ortilia* species. (63) *O. liriopoe* (Cramer), Obydos, Amazon; (64) *O. gentina* sp. n., Tucumán, Argentina.

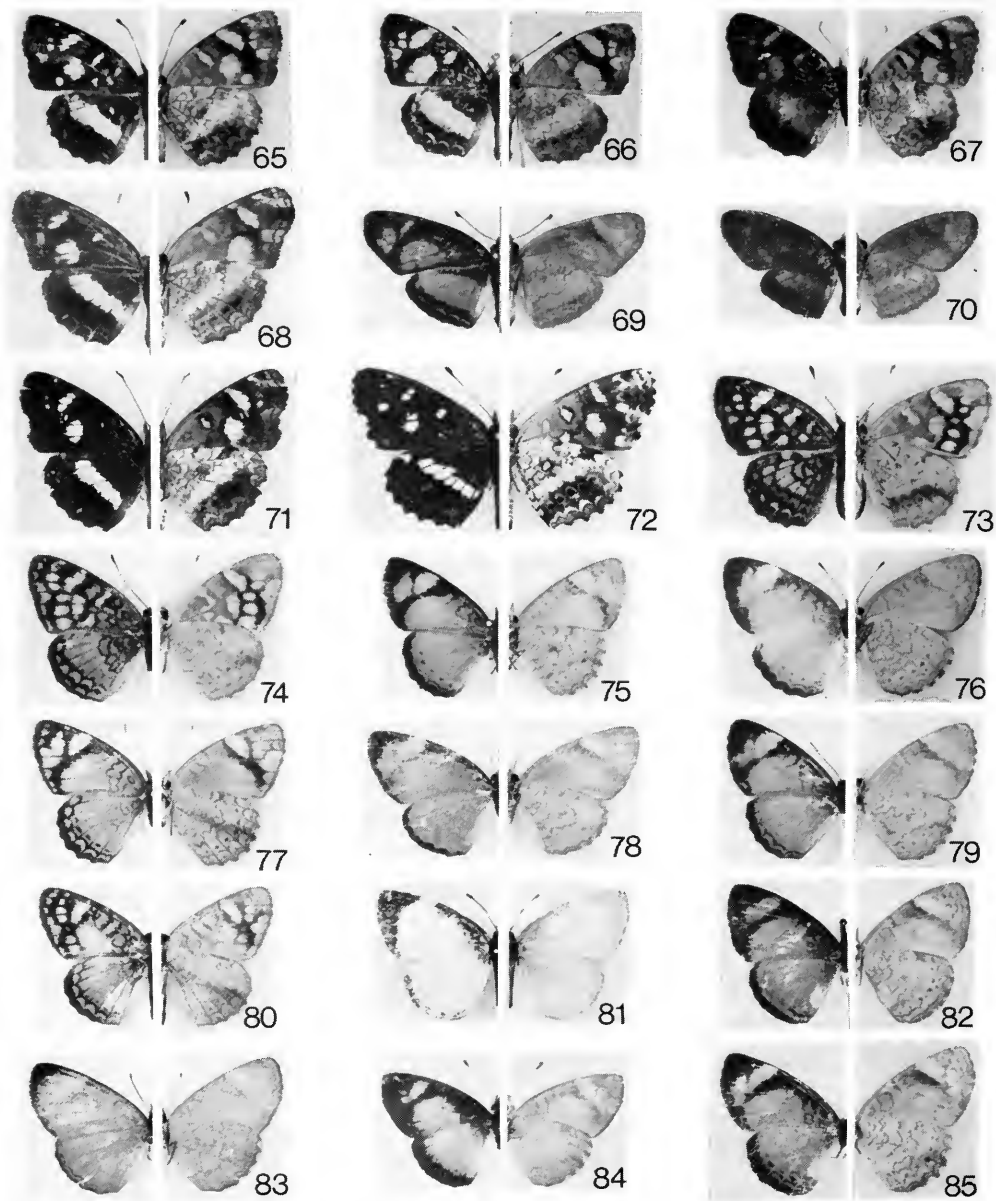

Figs 65–85 65–72, *Ortilia* species. (65) *O. orthia* (Hewitson), Sapucay, Paraguay; (66) *O. sejona* (Schaus), Goias, Brazil; (67) *O. velica* (Hewitson), São Paulo, Brazil; (68) *O. zamora* (Hall), Espiritu Santo, Brazil; (69) *O. dicoma* (Hewitson), Sapucay, Paraguay; (70) *O. polinella* (Hall), San Fidelis, Rio de Janeiro; (71) *O. orticas* (Schaus), Rio de Janeiro, Brazil; (72) *O. ithra* (Kirby), Rio Iguassu, Brazil. 73, 74, *Tisona* species. (73) *T. saladillensis saladillensis* (Giacomelli), Salta, Argentina; (74) *T. saladillensis clarior* subsp. n., Bolivia. 75–85, *Tegosa* species. (75) *T. claudina* (Escholtz), Iguassu, Parana, Brazil; (76) *T. similis* nom. n., Siapure, Venezuela; (77) *T. orobia* (Hewitson), Sapucay, Paraguay; (78) *T. fragilis* (Bates), Altamira, Brazil; (79) *T. infrequens* sp. n., Petropolis, Brazil; (80) *T. ursula* (Staudinger), Sierra de Aconquija, N. Argentina; (81) *T. flavida* (Hewitson), N. Peru; (82) *T. pastazena* (Bates), Pozzuzo, E. Peru; (83) *T. guatemalena* (Bates), Oaxaca, Mexico; (84) *T. anieta anieta* (Hewitson) ♂, El Valle, Panama; (85) same ♀, San Luis Potosi, Mexico.

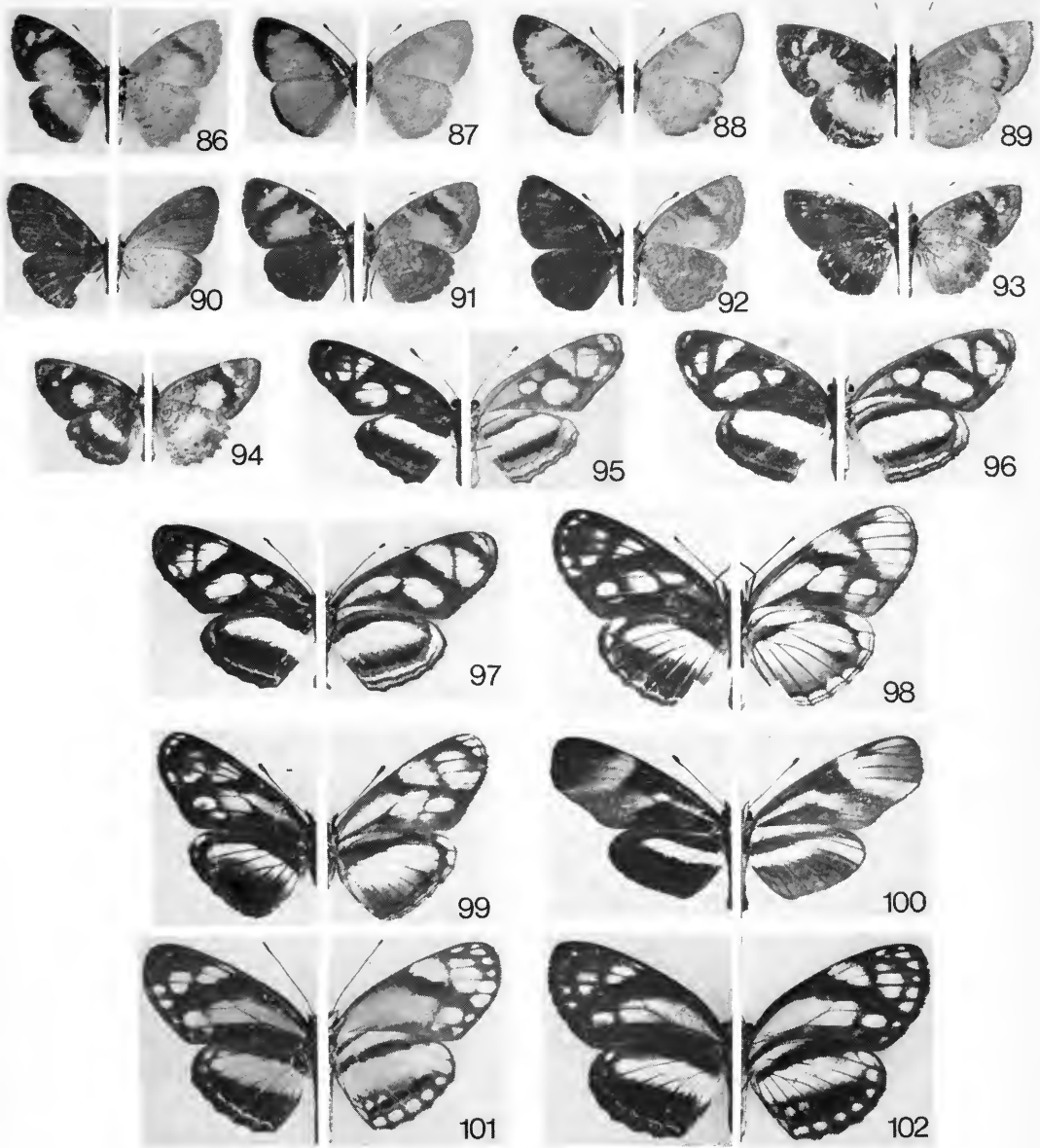

**Figs 86–102** 86–94, *Tegosa* species. (86) *T. anieta cluvia* (Godman & Salvin), La Paz, Bolivia; (87) *T. anieta luka* subsp. n., Pacho, Colombia; (88) *T. anieta serpia* subsp. n., Tarapoto, Peru; (89) *T. nazaria* (Felder & Felder), Bogota, Colombia; (90) *T. tissoides* (Hall), Salidero, N. W. Ecuador; (91) *T. etia* (Hewitson), Cochabamba, Bolivia; (92) same, Chachapoyas, Peru; (93) *T. nigrella* (Bates), San Geronimo, Guatemala; (94) same, Cache, Costa Rica. 95–102, *Eresia* species. (95) *E. nauplius nauplius* (L.), Cayenne, Guyana; (96) *E. nauplius extensa* (Hall), Matto Grosso, Brazil; (97) *E. plagiata* (Röber), Santo Paulo d'Olivencia, Brazil; (98) *E. letitia letitia* Hewitson, Tolima, Colombia; (99) *E. letitia ocellata* (Röber), Chanchamayo, Peru; (100) *E. lansdorfi* (Godart), Iguassu, Parana, Brazil; (101) *E. sestia* Hewitson ♂, Paramba, Ecuador; (102) same ♀, Zaruma, Ecuador.

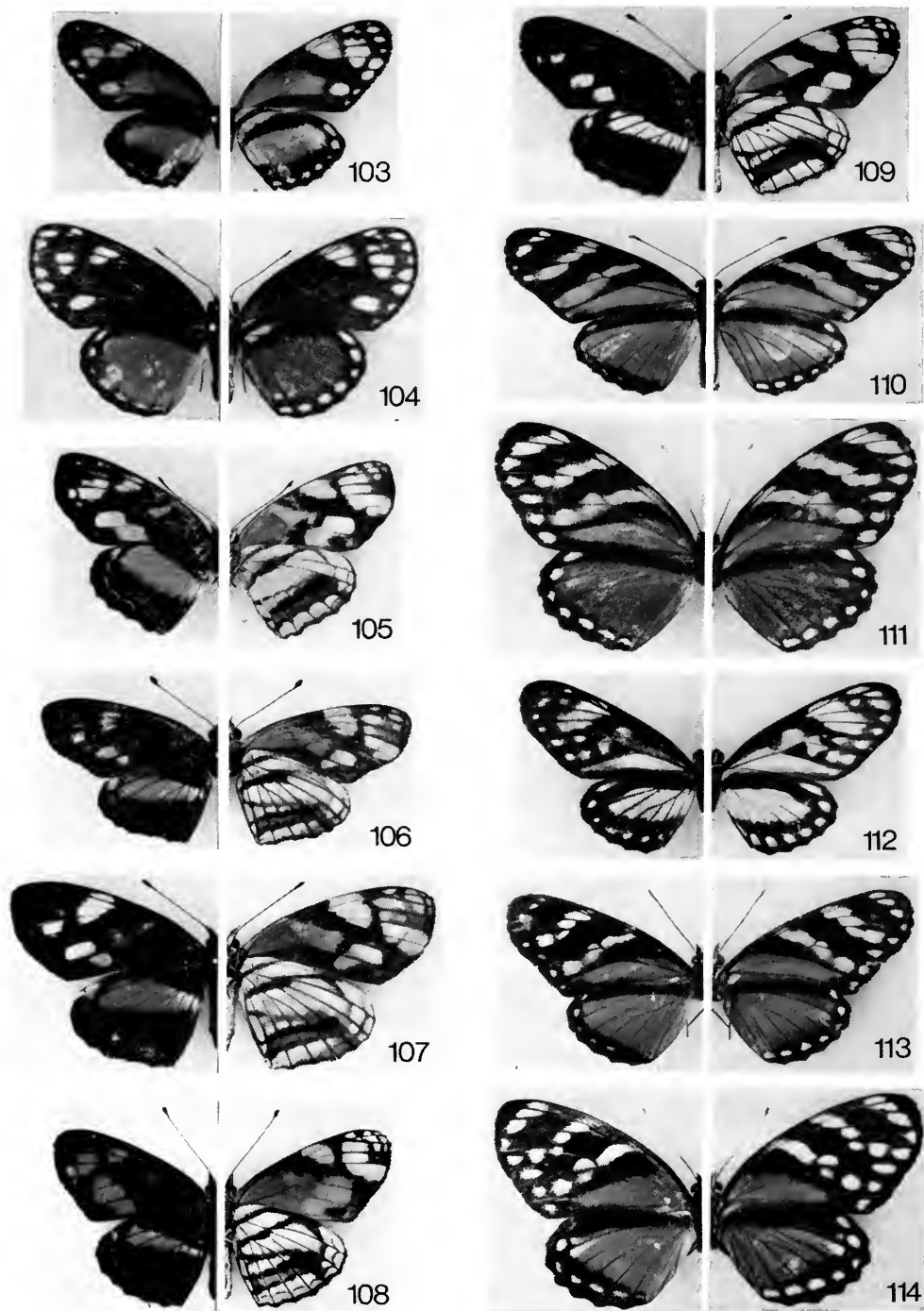

Figs 103–114 *Eresia* species. (103) *E. coela* Druce ♂, Limon, Costa Rica; (104) same ♀, Guapiles, Costa Rica; (105) *E. oblita* (Staudinger), San Esteban, Venezuela; (106) *E. carne carne* Doubleday ♂, Venezuela; (107) same ♀ holotype, no locality [Venezuela]; (108) *E. carne laias* Godman & Salvin, Rio Aquatil, W. Colombia; (109) *E. polina* Hewitson, Cochabamba, Bolivia; (110) *E. alsina* Hewitson ♂, Cache, Costa Rica; (111) same ♀, Jinotega, Nicaragua; (112) *E. cissia* (Hall), Bogota, Colombia; (113) *E. eutropia* Hewitson ♂, El Valle, Panama; (114) same ♀, El Valle, Panama.

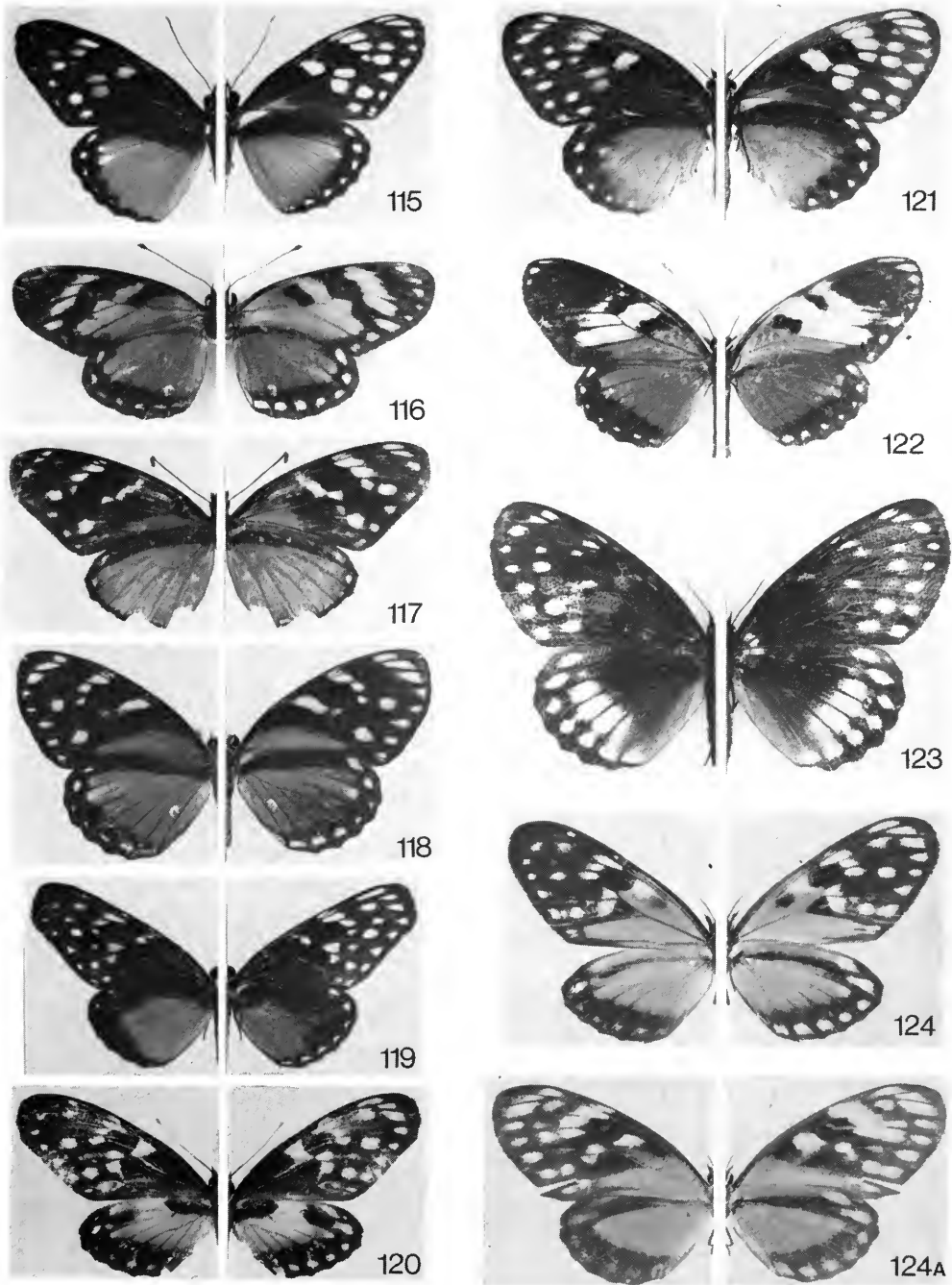

Figs 115–124 *Eresia* species. (115) *E. poecilina* Bates ♂, Chiriqui, Panama; (116) *E. mimas* (Staudinger) ♂, Rio San Juan, W. Colombia; (117) *E. melaina* sp. n. ♂, Veraguas, Panama; (118) same ♀, El Valle, Panama; (119) *E. stricta* Schaus, Guapiles, Costa Rica; (120) *E. ithomioides ithomioides* Hewitson ♂, Rio Chili, Colombia; (121) *E. poecilina* Bates ♀ holotype, Santa Fé; (122) *E. quintilla* Hewitson, Cauca, Colombia; (123) *E. anomala* sp. n. ♀ holotype, Muzo, Colombia; (124) *E. ithomioides pseudocelemina* (Strand), Bogota, Colombia; (124a) *E. ithomioides ithomioides* Hewitson ♀, Juntas, Choco, Colombia.

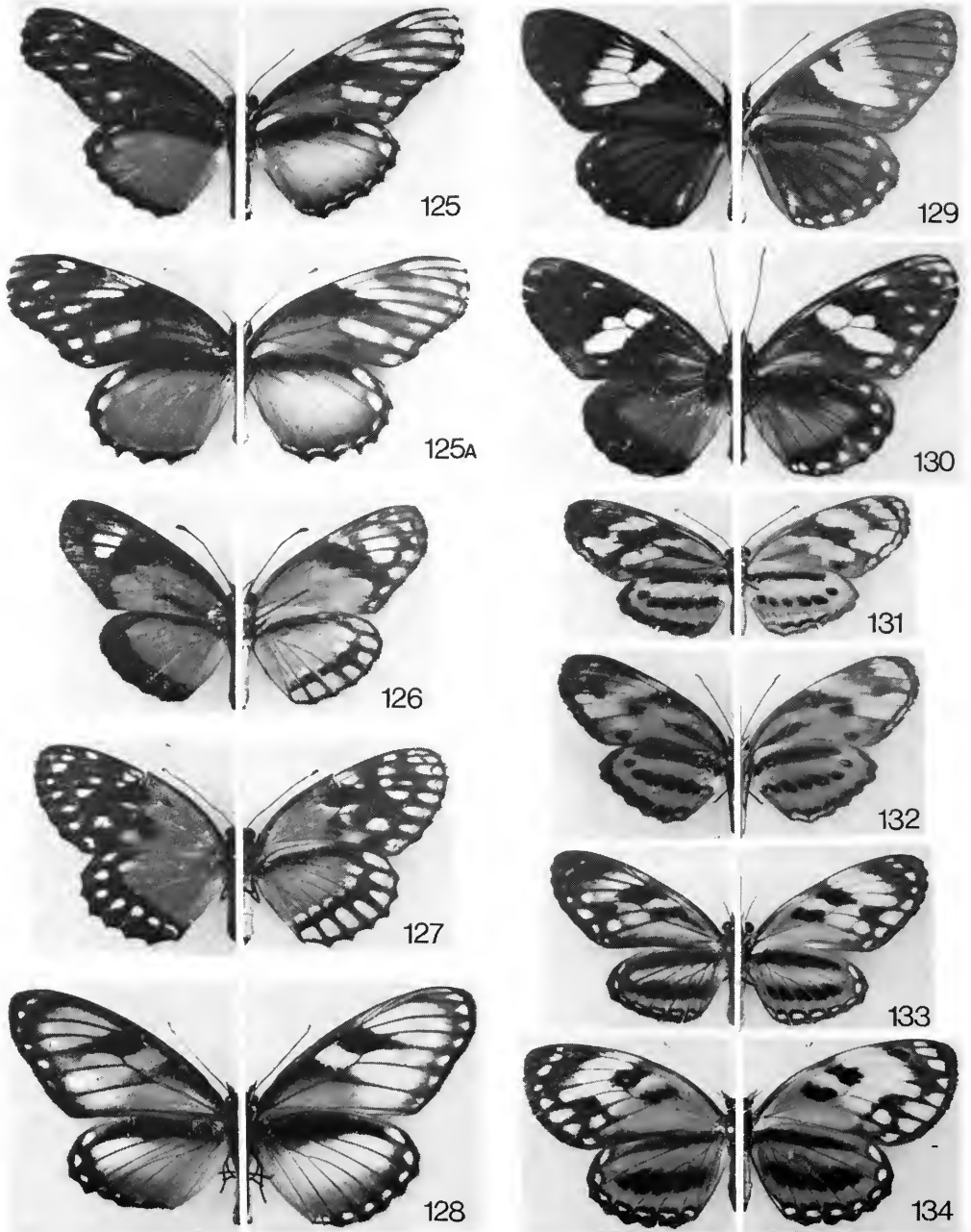

**Figs 125–134** *Eresia* species. (125) *E. nigripennis* Salvin ♂, Costa Rica; (125a) same ♀, Cache, Costa Rica; (126) *E. emerantia* Hewitson ♂, Colombia; (127) same ♀, Cananche, Colombia; (128) *E. phaedima* Salvin & Godman, Chanchamayo, Peru; (129) *E. datis datis* Hewitson, Cochabamba, Bolivia; (130) *E. margaretha* Hewitson, Colombia; (131) *E. eunice eunice* (Hübner), Para, Brazil; (132) *E. eunice olivencia* Bates, São Paulo da Olivencia, Brazil; (133) *E. etesia* (Hall) ♂, French Guiana; (134) same ♀, Cayenne, French Guiana.



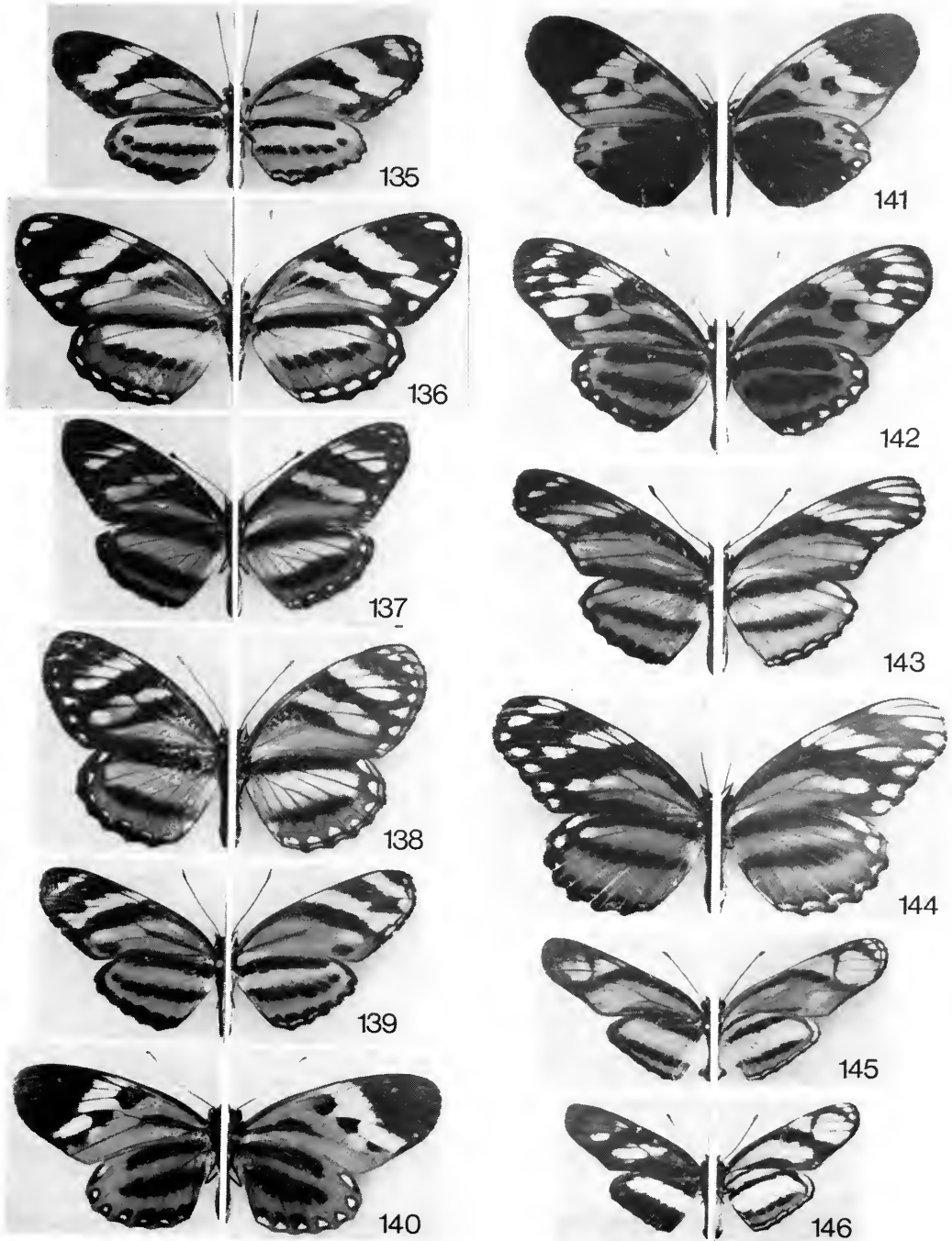

**Figs 135–146** *Eresia* species. (135) *E. eunice esora* Hewitson, São Paulo, Brazil; (136) *E. erysice* (Geyer) ♀, Bahia, Brazil; (137) *E. casiphia* Hewitson ♂, Balsapamba, Bolivar, Ecuador; (138) same ♀, Balsapamba, Bolivar, Ecuador; (139) *E. mechanitis* Godman & Salvin, Chontales, Costa Rica; (140) *E. pelonia* Hewitson ♂, Sarayacu, Ecuador; (141) same, Peru; (142) same ♀, Pebas, Amazon; (143) *E. phillyra* Hewitson ♂, Cordoba, Mexico; (144) same ♀, Honduras; (145) *E. aveyrona aveyrona* Bates, Cayenne, French Guiana; (146) *E. perna* Hewitson, Espirito Santo, Brazil.

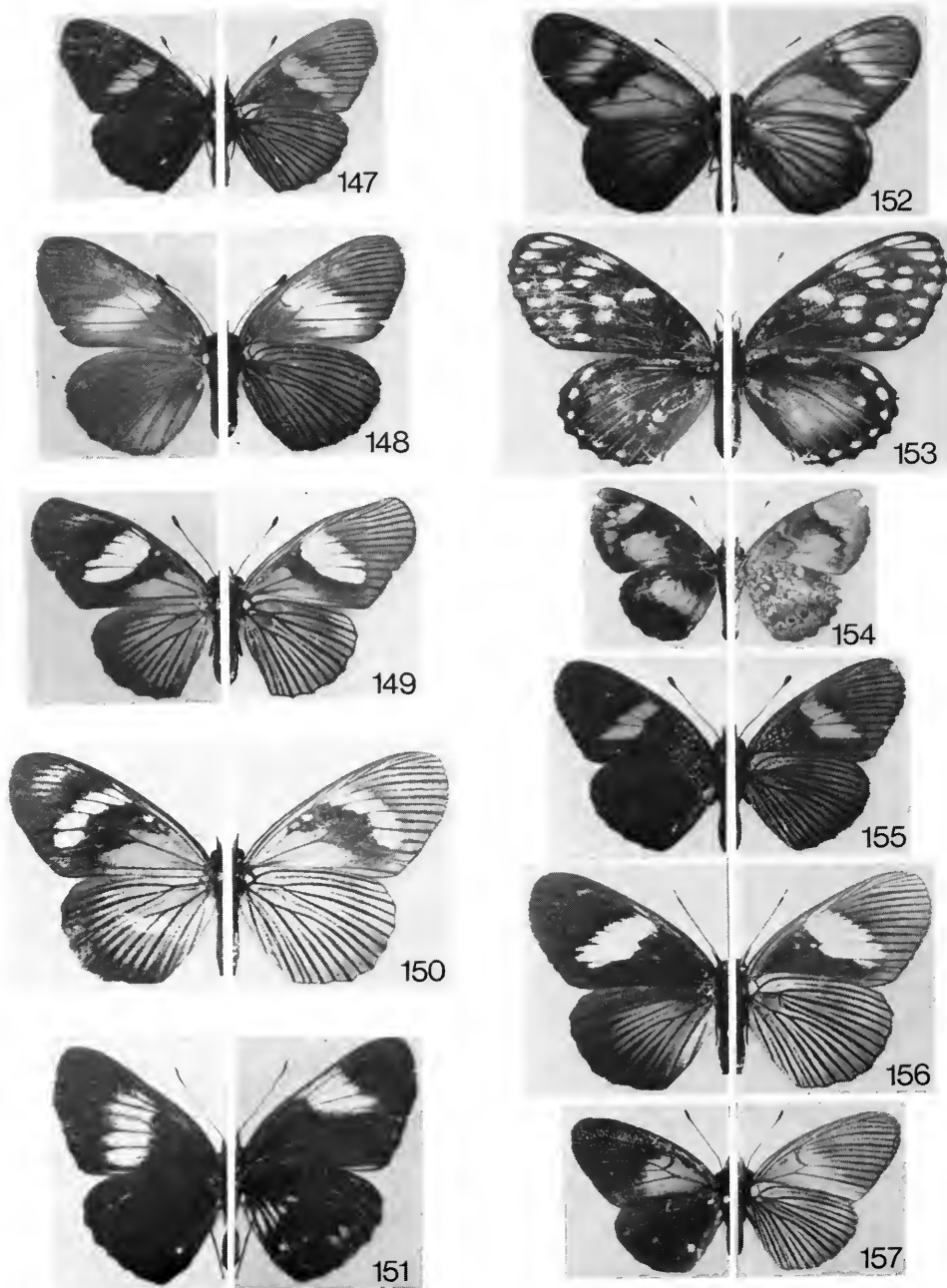

**Figs 147–157** 147–150, *Castilia* species. (147) *C. occidentalis* (Fassl) ♂, Cauca, Colombia; (148) same ♀, lectotype of *aurora* Röber, Zamora, Ecuador; (149) *C. perilla* (Hewitson) ♂, Peru; (150) same ♀, Moyabamba, Peru. 151–154, *Eresia* species. (151) *E. levina* Hewitson, Manizales, Colombia; (152) *E. actinote* Salvin ♂, Peru; (153) same ♀, Carillo, Costa Rica; (154) *E. selene* (Röber), Manizales, Colombia. 155–157, *Castilia* species. (155) *C. castilla* (Felder & Felder) ♂, Bogota, Colombia; (156) same ♀, Bogota, Colombia; (157) *C. neria* (Hewitson), Ecuador.



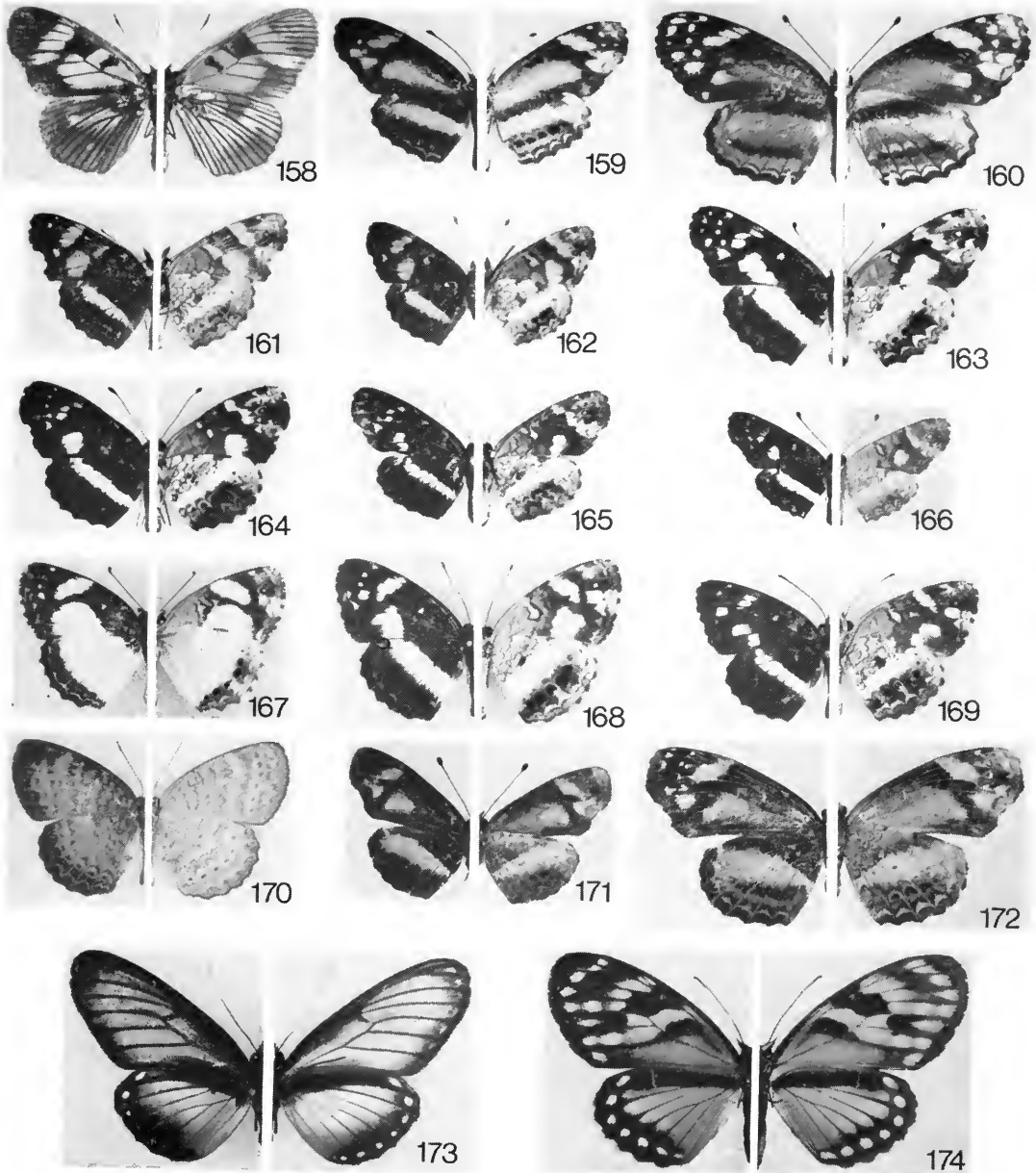

**Figs 158–174** 158–166, *Castilia* species. (158) *C. northbrunii* (Weeks), Cochabamba, Bolivia; (159) *C. eranites* (Hewitson) ♂, Balzapamba, Ecuador; (160) same ♀, Costa Rica; (161) *C. fulgora* (Godman & Salvin), Castajal, Costa Rica; (162) *C. fausta* (Godman & Salvin), Chiriqui, Panama; (163) *C. ofella* (Hewitson) Muzo, Colombia; (164) *C. myia* (Hewitson), Cordoba, Mexico; (165) *C. griseobasalis* (Röber), Santa Tecla, Guatemala; (166) *C. angusta* (Hewitson), Peru. 167–169, *Janatella* species. (167) *J. leucodesma* (Felder & Felder), Merida, Venezuela; (168) *J. hera* (Cramer), French Guyana; (169) *J. fellula* (Schaus), Cauca, Colombia. 170, *Mazia amazonica* (Bates), Sao Paulo d'Olivencia, Amazon. 171, 172, *Castilia* species. (171) *C. chinantlensis* (de la Maza) ♂, Oaxaca, Mexico; (172) same ♀, Oaxaca, Mexico. 173, 174, *Eresia* species. (173) *E. moesta* Salvin & Godman, Env. Bogota, Colombia; (174) *E. mimas* (Staudinger), Cauca, Juntas, Colombia.

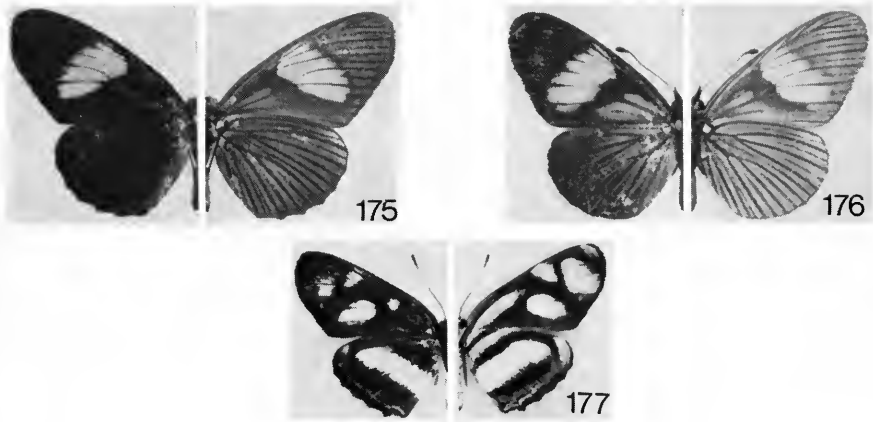

**Figs 175–177** 175, 176 *Castilia* species. (175) *C. perilla* f. *aricilla* (Hopffer), Pozuzo, Peru; (176) *C. perilla* f. *acraeina* (Hewitson), Moyobamba, Peru. 177, *Eresia clara* (Bates), Rio Cachiyaca, Iquitos, Peru.

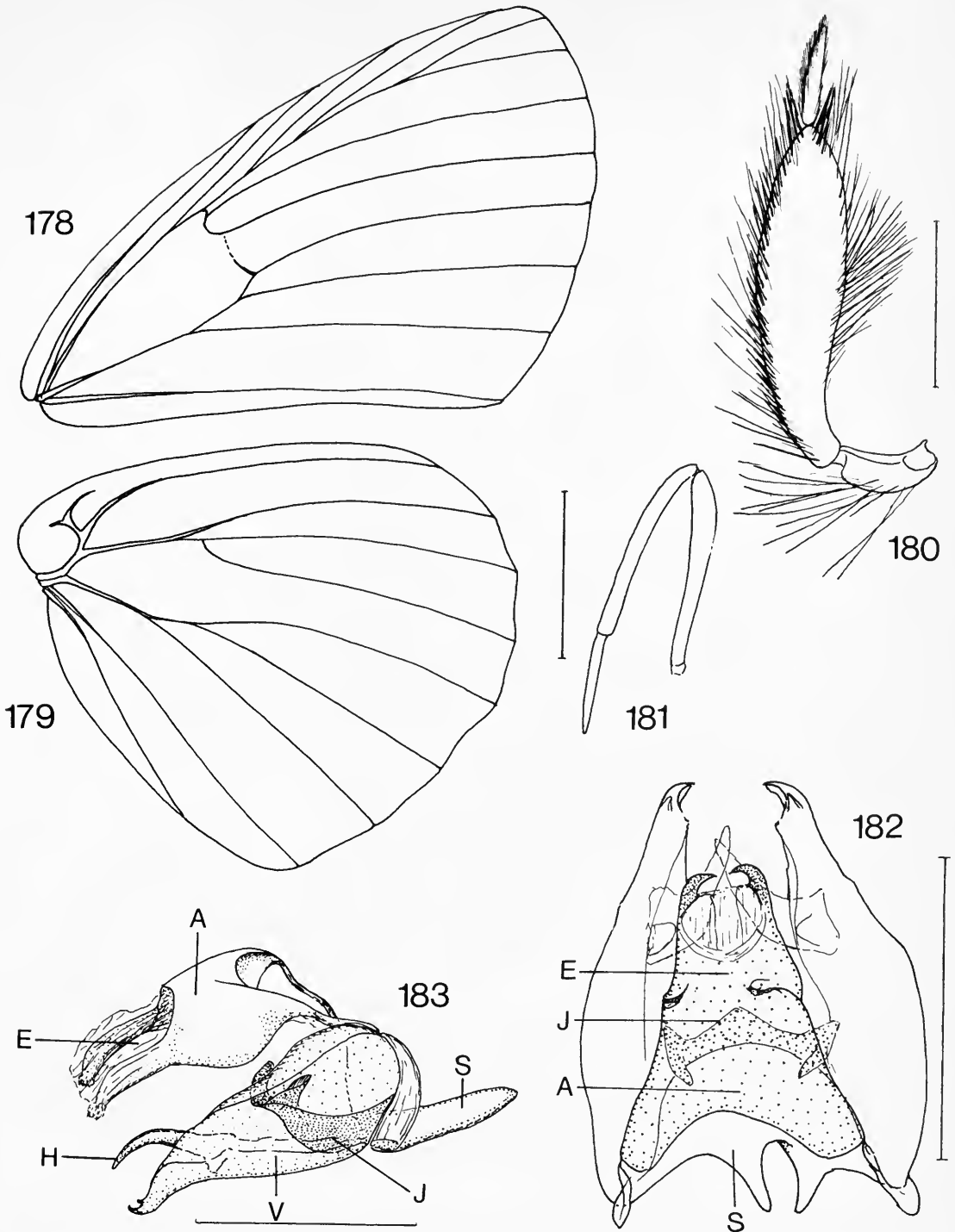

**Figs 178–183** 178–182, *Phyciodes* species. (178) *P. tharos*, forewing venation; (179) same, hindwing venation; (180) same, palpus, lateral view; (181) same, ♂ foreleg; (182) same, ♂ genitalia, dorsal view, anatomical structures lettered, Missouri, g/s 134. The posterior border of the juxta is seen rather obscurely through the chitinized tegumen. 183, *Eresia clara*, ♂ genitalia, lateral view, penis removed, showing dorsal structures. A = tegumen; E = scaphial extension; S = saccus; J = juxta; H = harpe; V = valve. Scale = 1 mm.

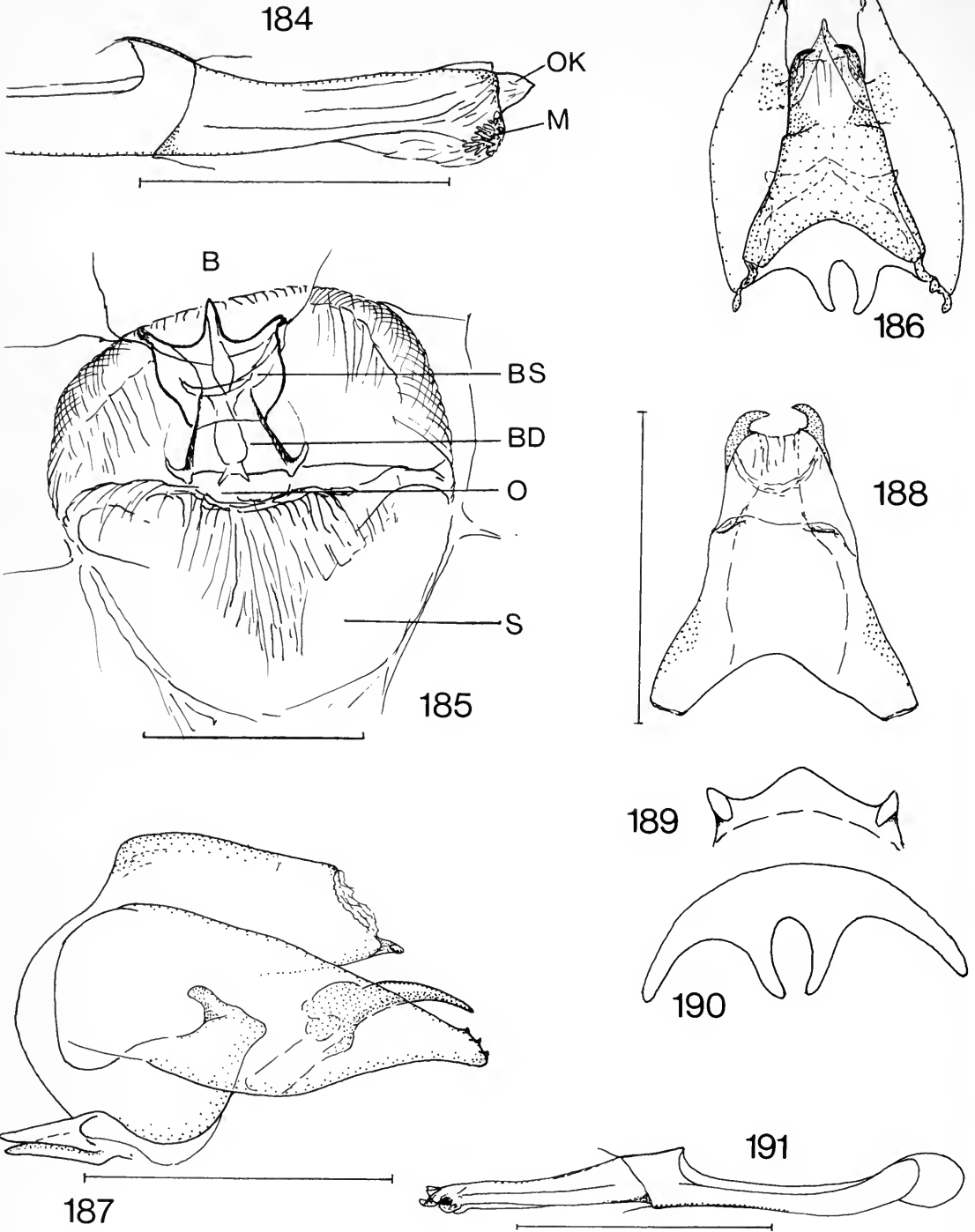

**Figs 184-191** 184, 185, *Eresia* species. (184) *E. clara*, penis, lateral view of distal section, showing apical structures lettered. OK = ostium keel of penis; M = morula of penis. (185) *E. phillyra*, ♀ sterigma, showing structure of the genital plate and bursal support. B = position of bursa; BS = bursal support; BD = bursal duct; O = ostium bursae; S = scutum. 186-191 *Phyciodes* species. (186) *P. tharos*, ♂ genitalia, dorsal view, Chicago, g/s 1230; (187) same, ♂ genitalia, lateral view, Connecticut, g/s 1233; (188) same, tegumen + scaphial extensions; (189) same, posterior border of juxta; (190) same, saccus; (191) same, penis, lateral view, Chicago, g/s 1230. Scale = 1 mm.

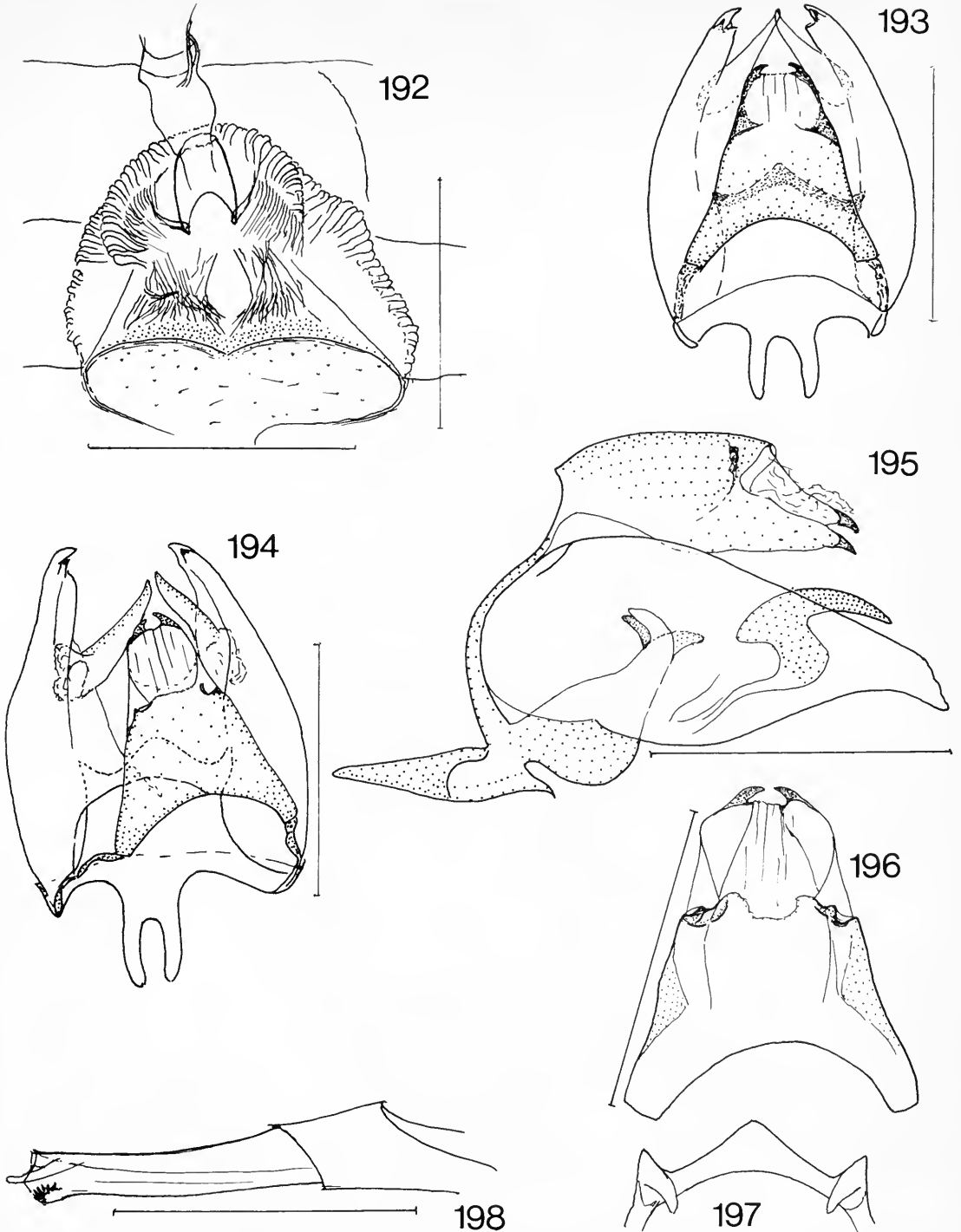

**Figs 192–198** *Phyciodes* species. (192) *P. tharos*, ♀ genitalia, dorsal view, Chicago, g/s 128; (193) *P. batesii*, ♂ genitalia, dorsal view, Scranton, Penn., g/s 130; (194) *P. campestris campestris*, ♂ genitalia, dorsal view, Oregon, g/s 422; (195) same, lateral view, Yosemite, g/s 2597; (196) same, tegumen, California, g/s 421; (197) same, posterior border of juxta, California, g/s 421; (198) same, penis, lateral view, Wyoming, g/s 2592. Scale = 1 mm.

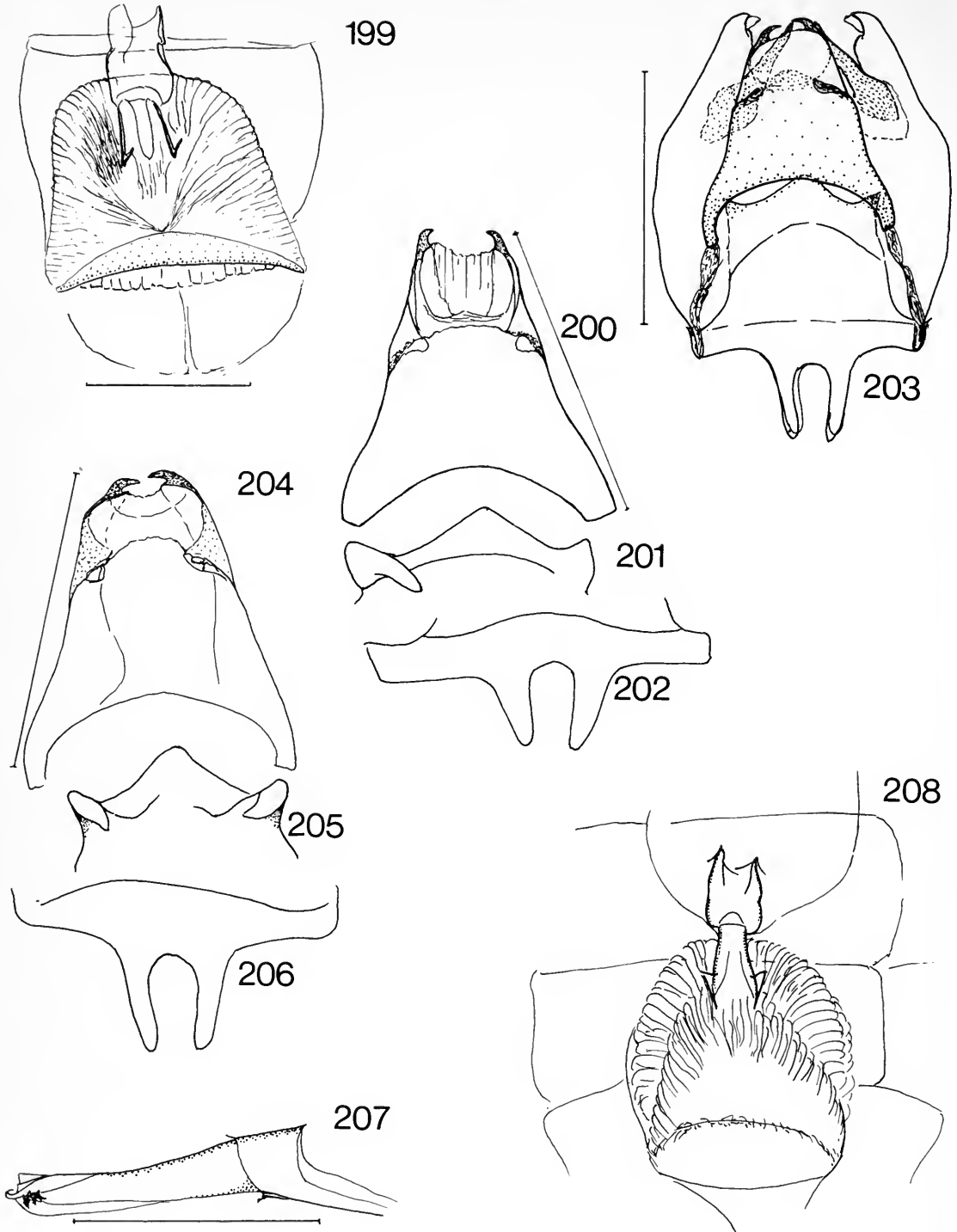

**Figs 199–208** *Phyciodes* species. (199) *P. campestris campestris*, ♀ genitalia, Alberta, g/s 1057; (200) *P. c. camillus*, ♂ tegumen, Wyoming, g/s 1592; (201) same, posterior border of juxta, Wyoming, g/s 1592; (202) same, saccus, Wyoming, g/s 1592; (203) *P. montanus*, ♂ genitalia, California, g/s 423; (204) same, ♂ tegumen, California, g/s 423; (205) same, posterior border of juxta, California, g/s 423; (206) same, saccus, California, g/s 423; (207) same, penis, lateral view, California, g/s 778; (208) same, ♀ genitalia, California, g/s 2617. Scale = 1 mm.

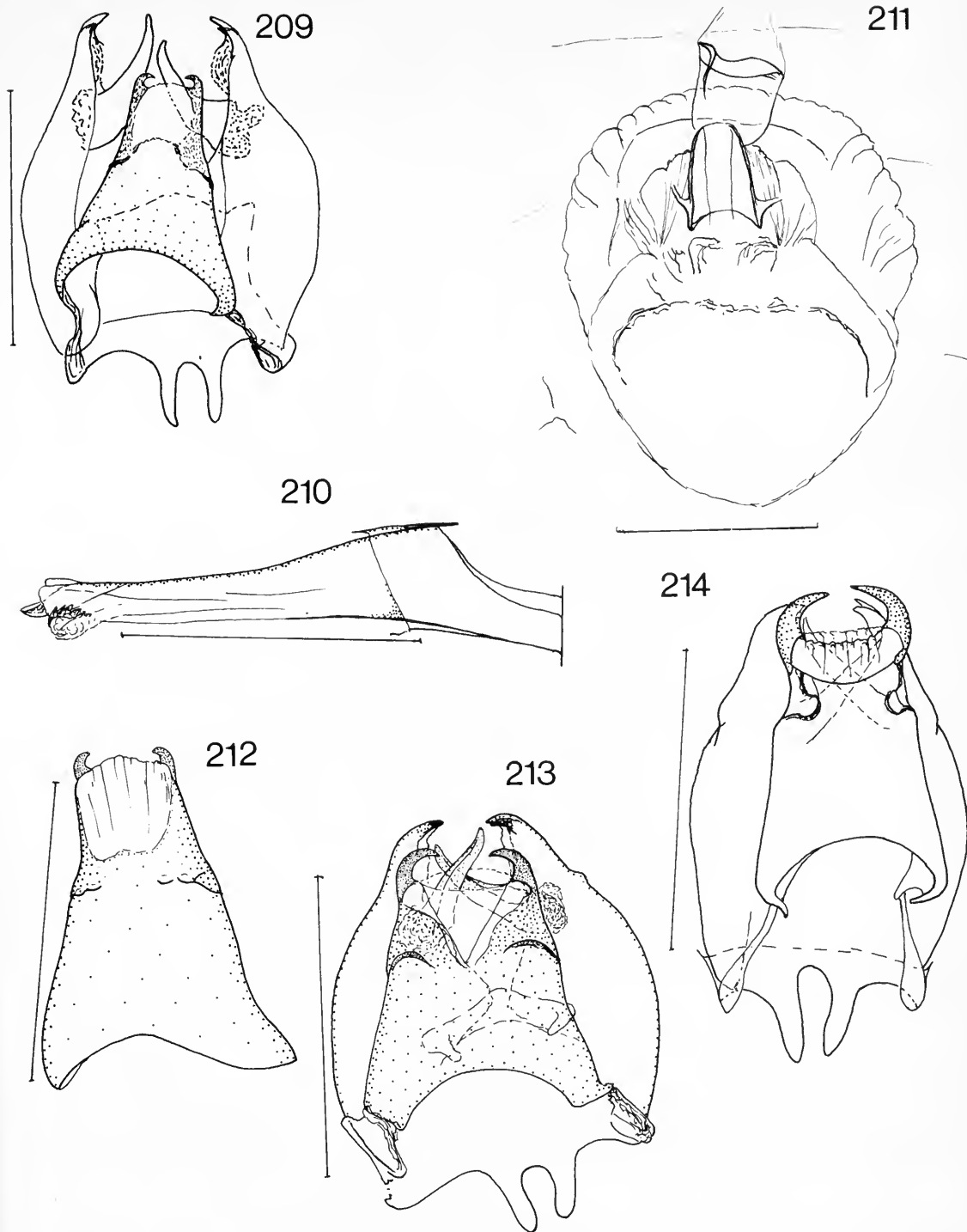

**Figs 209–214** *Phyciodes* species. (209) *P. mylitta*, ♂ genitalia, dorsal view, California, g/s 119; (210) *P. m. mylitta*, penis, lateral view, Golden, Colorado, g/s 794; (211) same, ♀ genitalia, Oregon, g/s 1056; (212) *P. orseis*, tegumen and scaphial extension, Oregon, Gold Hill, g/s 780; (213) *P. pictus pictus*, ♂ genitalia, dorsal view, Tucson, Arizona, g/s 792; (214) *P. pictus pallescens*, ♂ genitalia, dorsal view, Guadalajara, g/s 793. Scale = 1 mm.

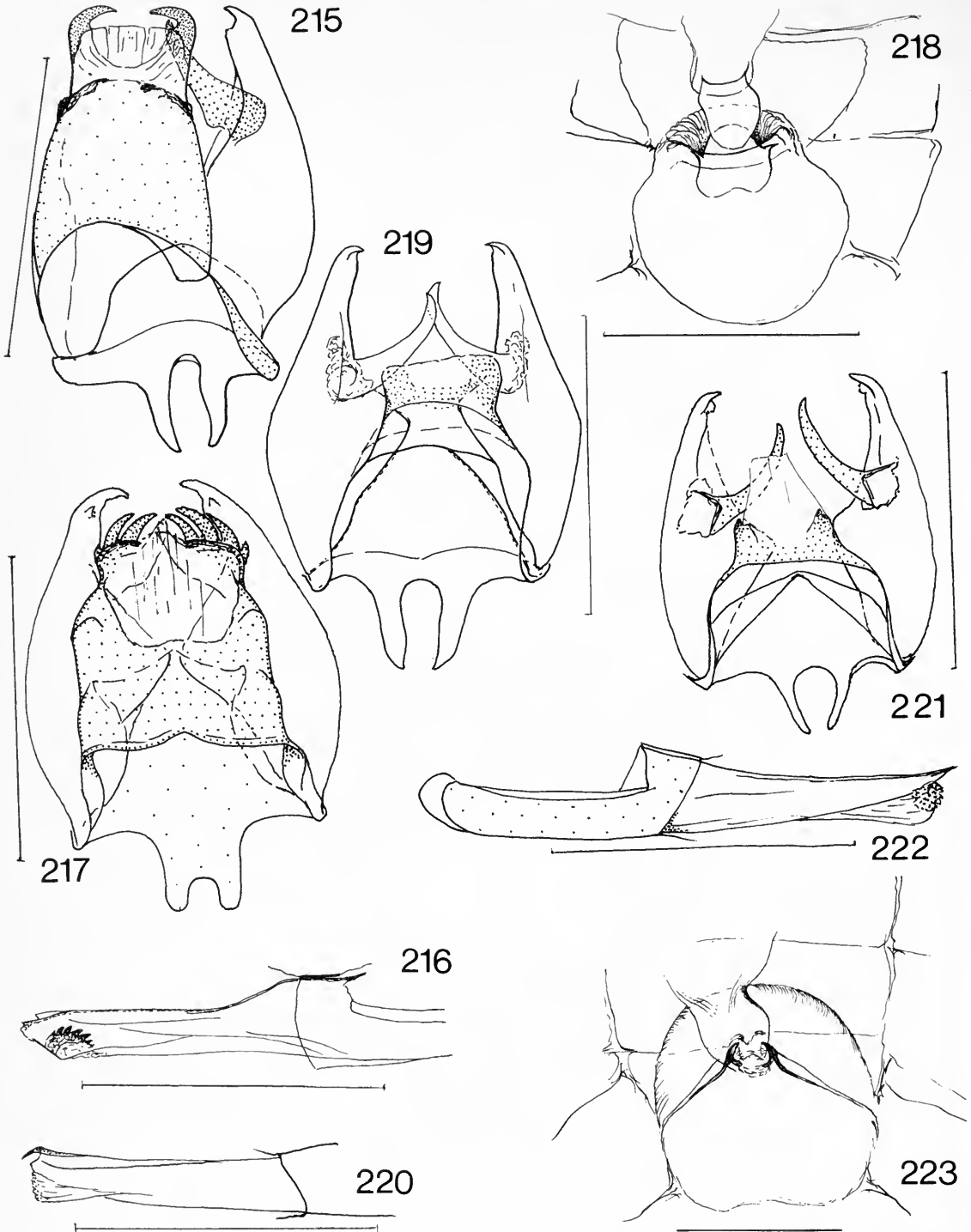

**Figs 215–223** 215–218, *Phyciodes* species. (215) *P. phaon*, ♂ genitalia, dorsal view, no locality, g/s 396; (216) same, penis, lateral view, no locality, g/s 396; (217) *P. vesta vesta*, ♂ genitalia, dorsal view, Texas, g/s 773; (218) same, ♀ sterigma, Colorado Springs, g/s 1079. 219–223, *Phystis* species. (219) *P. simois simois*, ♂ genitalia, dorsal view, Pernambuco, g/s 790; (220) same, penis, lateral view, Pernambuco, g/s 790; (221) *P. simois variegata* intermediate form, ♂ genitalia, dorsal view, Bahia, g/s 2755; (222) same, penis, lateral view, Bahia, g/s 2755; (223) same, ♀ genitalia, Cordoba, g/s 1078. Scale = 1 mm.



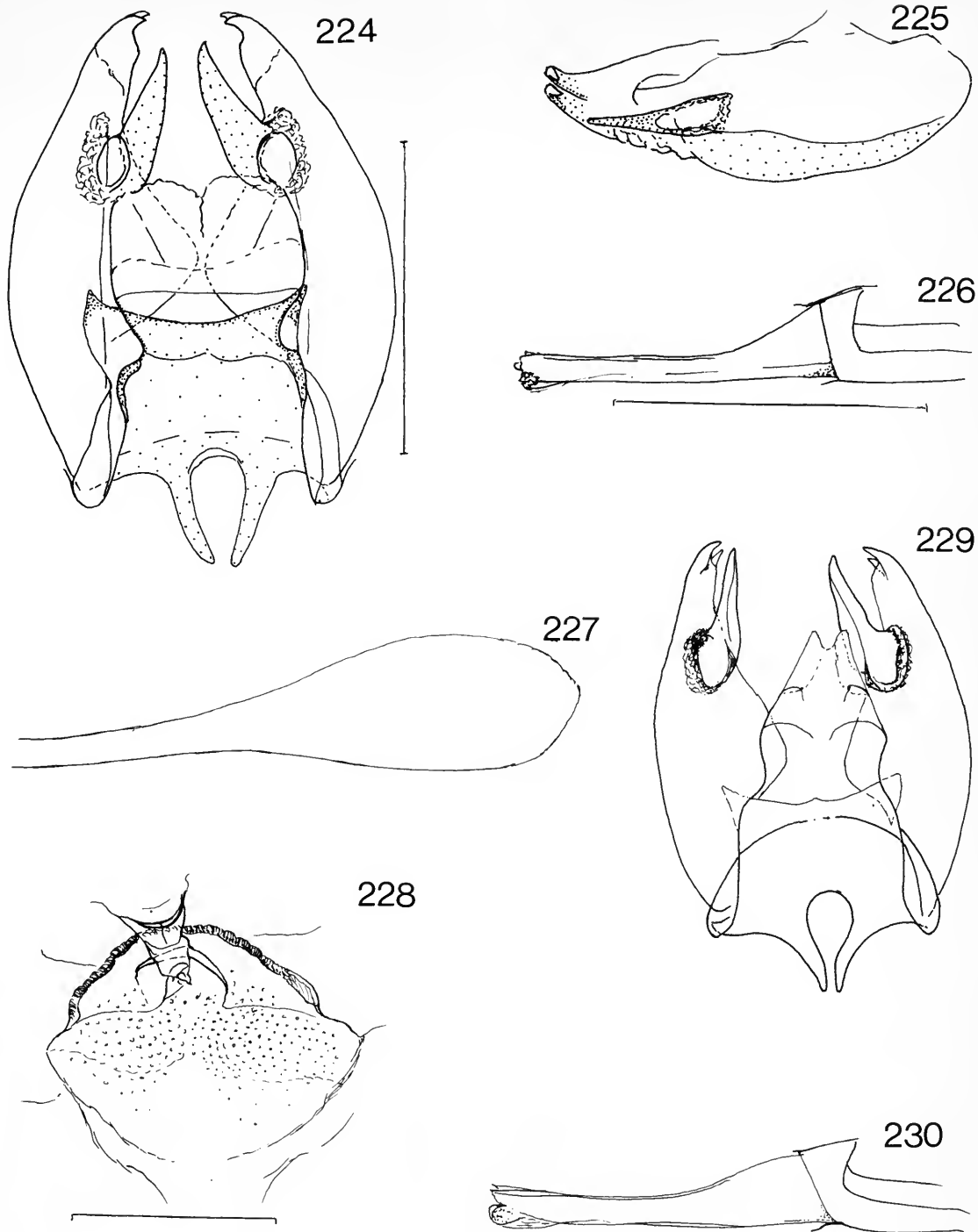

**Figs 224–230** *Anthanassa* species. (224) *A. drusilla drusilla*, ♂ genitalia, dorsal view, Colombia, g/s 1036; (225) same, valve, lateral view, Venezuela, g/s 2776; (226) same, penis, lateral view, Venezuela, g/s 1032; (227) same, pyriform antennal club; (228) same, ♀ genitalia, Colombia, g/s 1033; (229) *A. ptolyca ptolyca*, ♂ genitalia, dorsal view, Guatemala, g/s 106; (230) same, penis, lateral view, Guatemala, g/s 106. Scale = 1 mm.

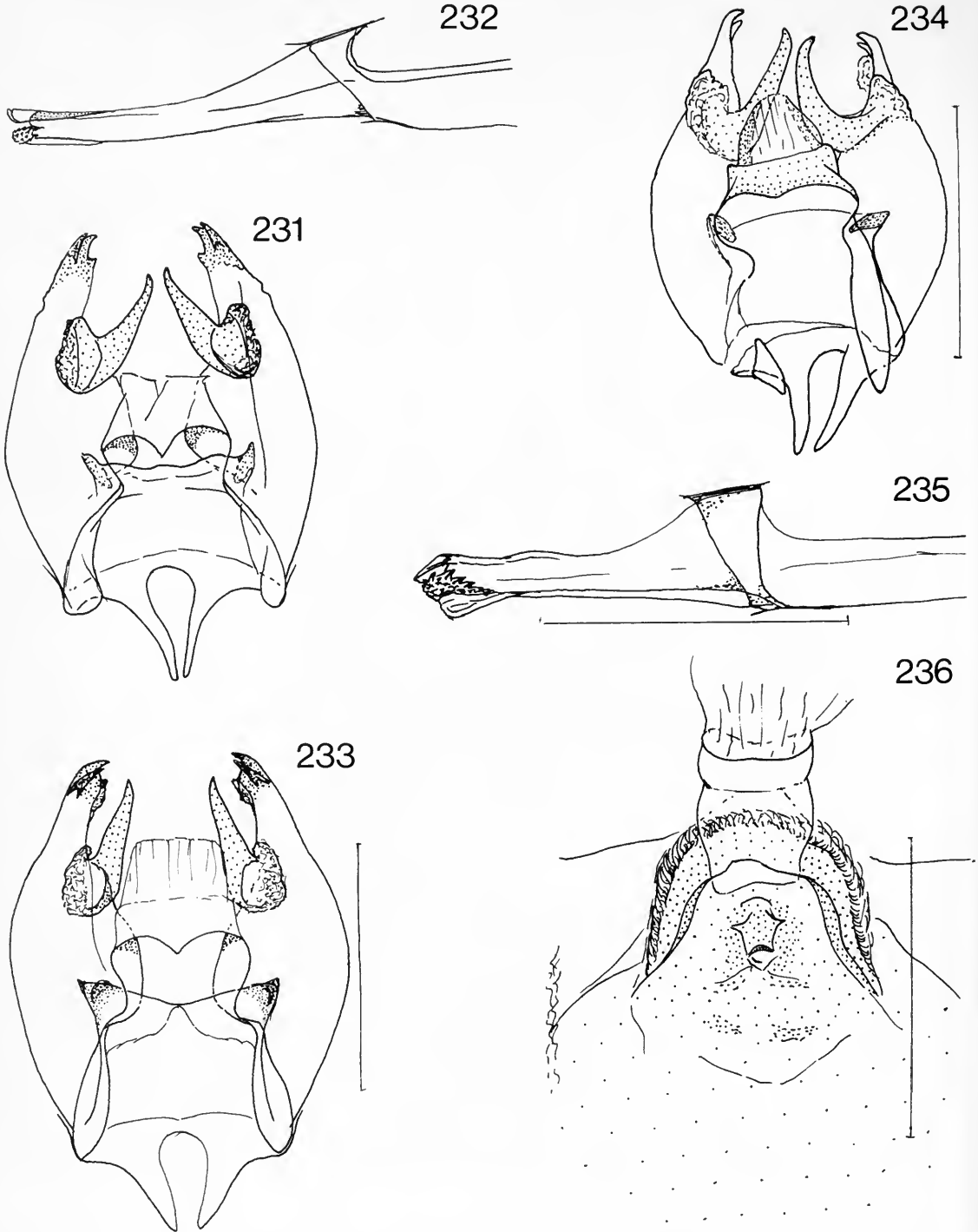

**Figs 231–236** *Anthanassa* species. (231) *A. ardys ardys*, ♂ genitalia, dorsal view, Costa Rica, g/s 814; (232) same, penis, lateral view, Colombia, g/s 1350; (233) *A. ardys subota*, ♂ genitalia, dorsal view, Guatemala, g/s 2565; (234) *A. dracaena*, ♂ genitalia, dorsal view, Colombia, g/s 817; (235) same, penis, lateral view, Colombia, g/s 817; (236) same, ♀ genitalia, Colombia, g/s 817. Scale = 1 mm.

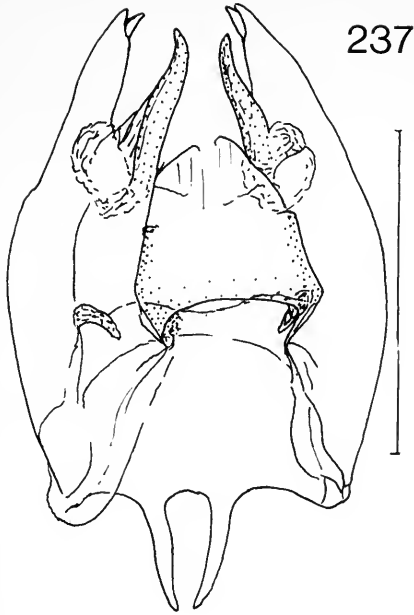

237

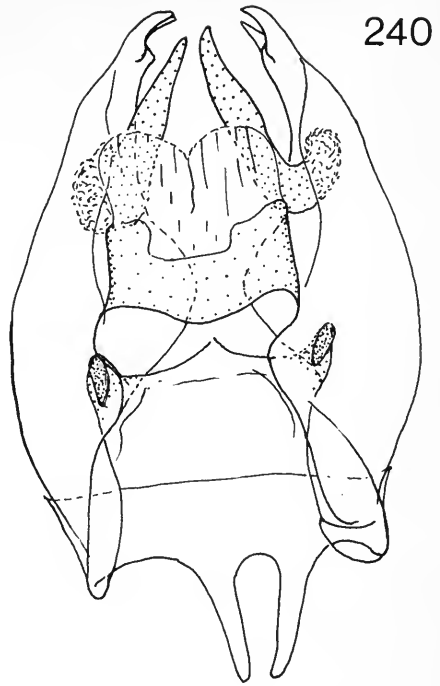

240

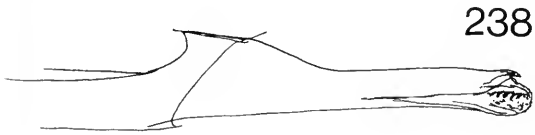

238

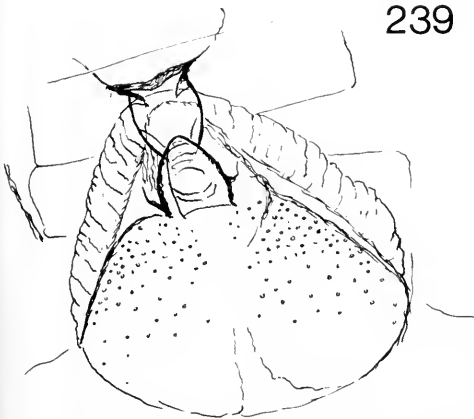

239

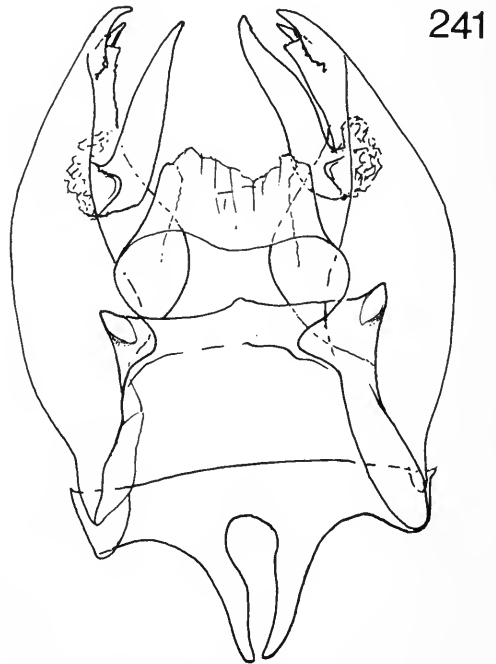

241

**Figs 237–241** *Anthanassa* species. (237) *A. texana texana*, ♂ genitalia, dorsal view, Texas, g/s 1042; (238) same, penis, lateral view, Texas, g/s 1042; (239) same, ♀ genitalia, Texas, g/s 1050; (240) *A. alexon subconcolor*, ♂ genitalia, dorsal view, Arizona, g/s 801; (241) *A. acesas*, ♂ genitalia, dorsal view, Venezuela, g/s 1024. Scale = 1 mm.

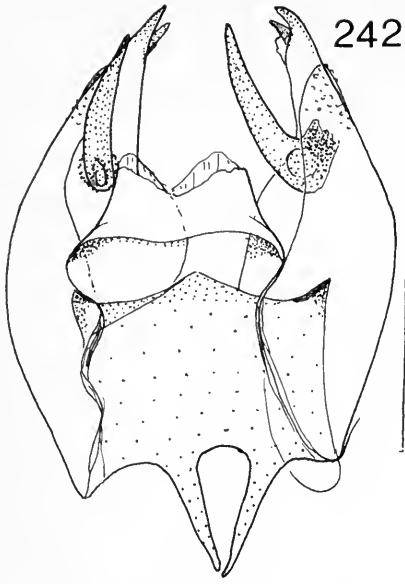

242

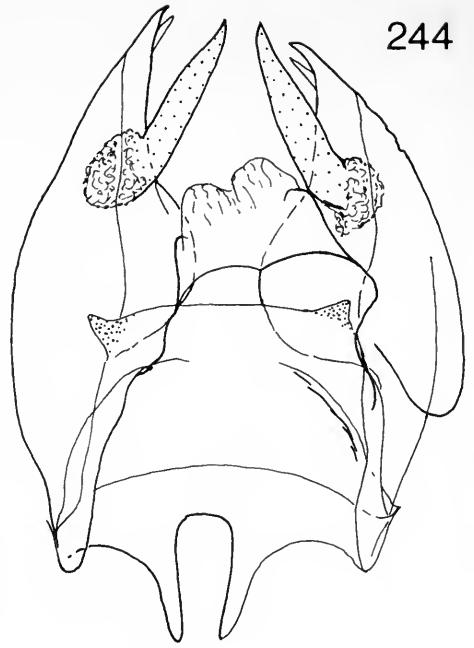

244

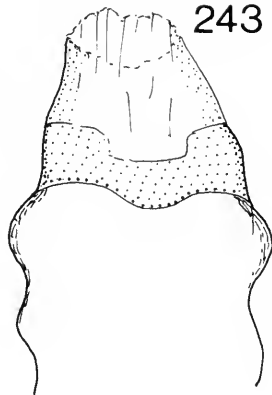

243

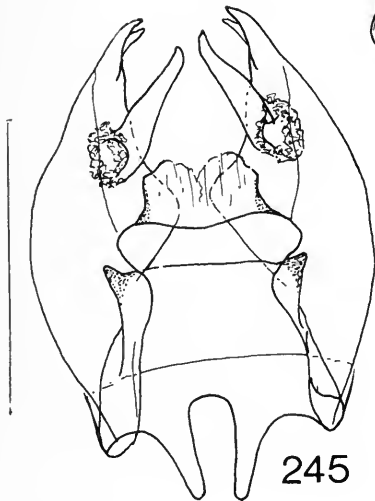

245

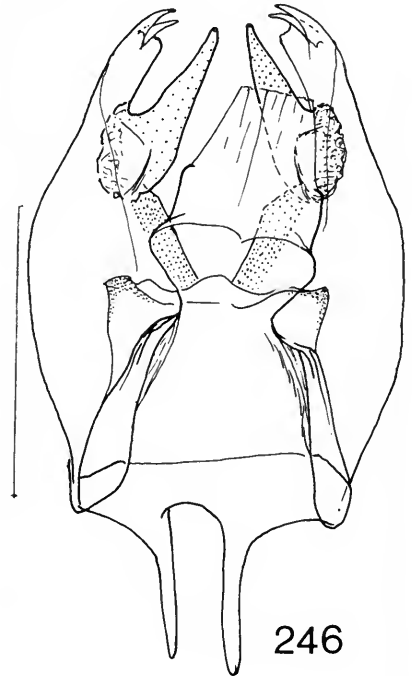

246

Figs 242–246 *Anthanassa* species. (242) *A. nebulosa*, ♂ genitalia, dorsal view, N. Colombia, Sierra Nevada de Sante Marta, Chichihua Valley (f. *castianira*), g/s 110; (243) same, tegumen and scaphial extension, g/s 1252; (244) *A. argentea*, ♂ genitalia, dorsal view, Guatemala, g/s 1018; (245) *A. atronia*, ♂ genitalia, dorsal view, Guatemala, g/s 829; (246) *A. otones*, ♂ genitalia, dorsal view, Guatemala, g/s 1247. Scale = 1 mm.

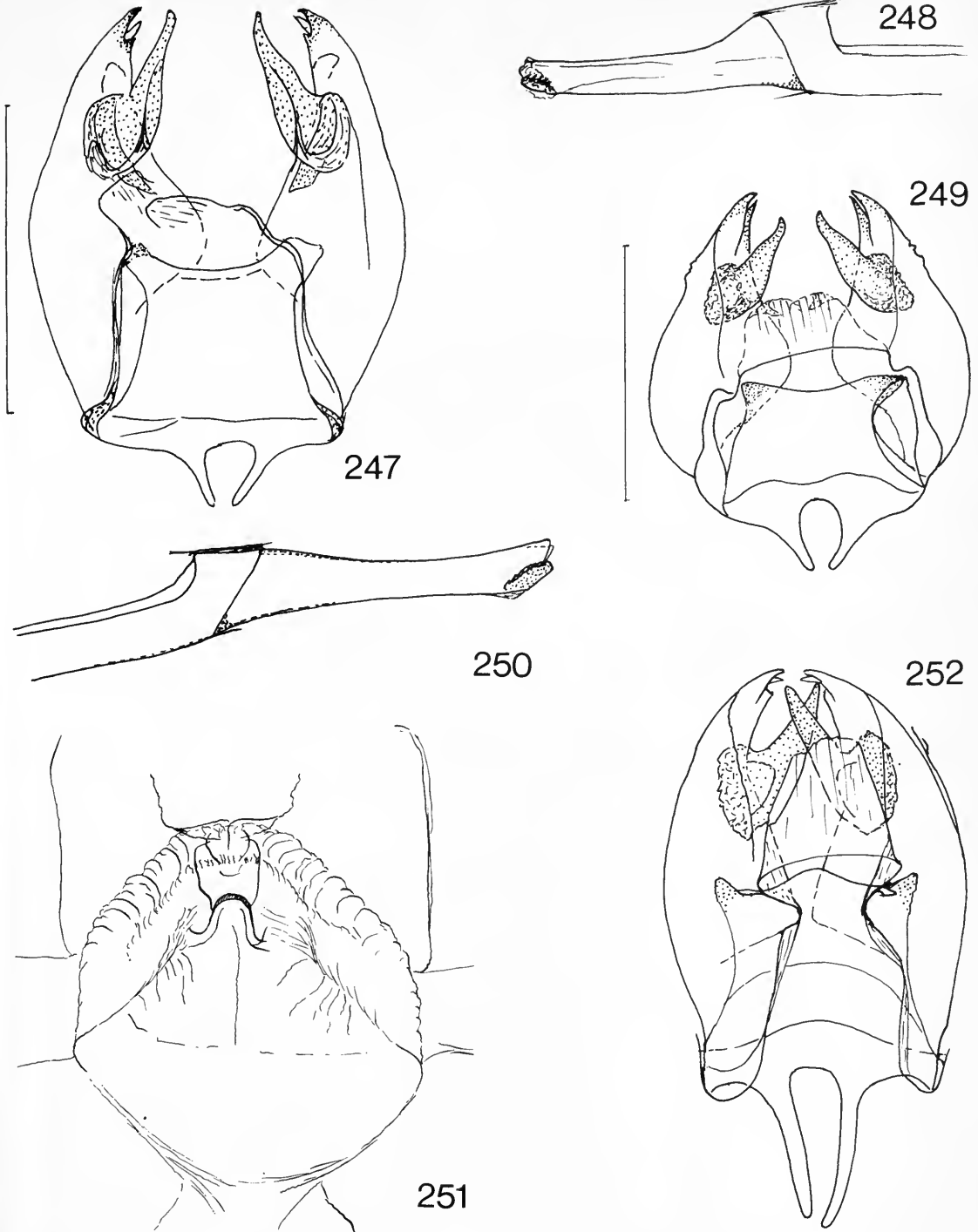

**Figs 247–252** *Anthanassa* species. (247) *A. annulata*, ♂ genitalia, dorsal view, Ecuador, g/s 1351; (248) same, penis, lateral view of distal section, Ecuador, g/s 1351; (249) *A. crithona*, ♂ genitalia, dorsal view, Costa Rica, g/s 2578; (250) same, penis, lateral view, Costa Rica, g/s 807; (251) same, ♀ genitalia, dorsal view, Panama, g/s 1049; (252) *A. fulviplaga*, ♂ genitalia, dorsal view, Costa Rica, g/s 833. Scale = 1 mm.

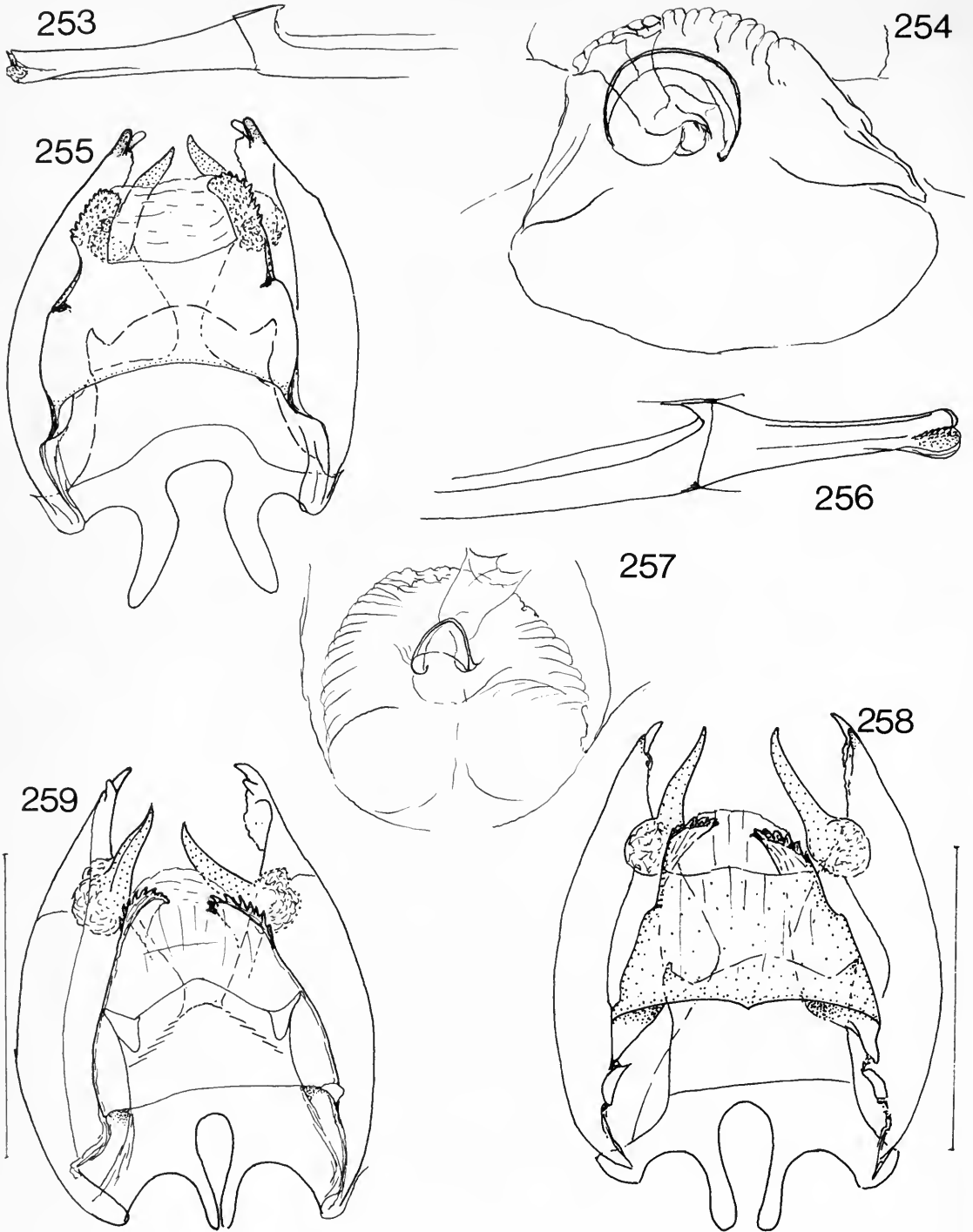

**Figs 253–259** *Anthanassa* species. (253) *A. fulviplaga*, penis, lateral view, Costa Rica, g/s 833; (254) same, ♀ genitalia, Costa Rica, g/s 1066; (255) *A. hermas*, ♂ genitalia, dorsal view, Paraguay, g/s 111; (256) same, penis, lateral view, Paraguay, g/s 111; (257) same, ♀ genitalia, dorsal view, Brazil, g/s 1067; (258) *A. frisia*, ♂ genitalia, Cuba, g/s 2780; (259) same, ♂ genitalia, Jamaica, g/s 879. Scale = 1 mm.

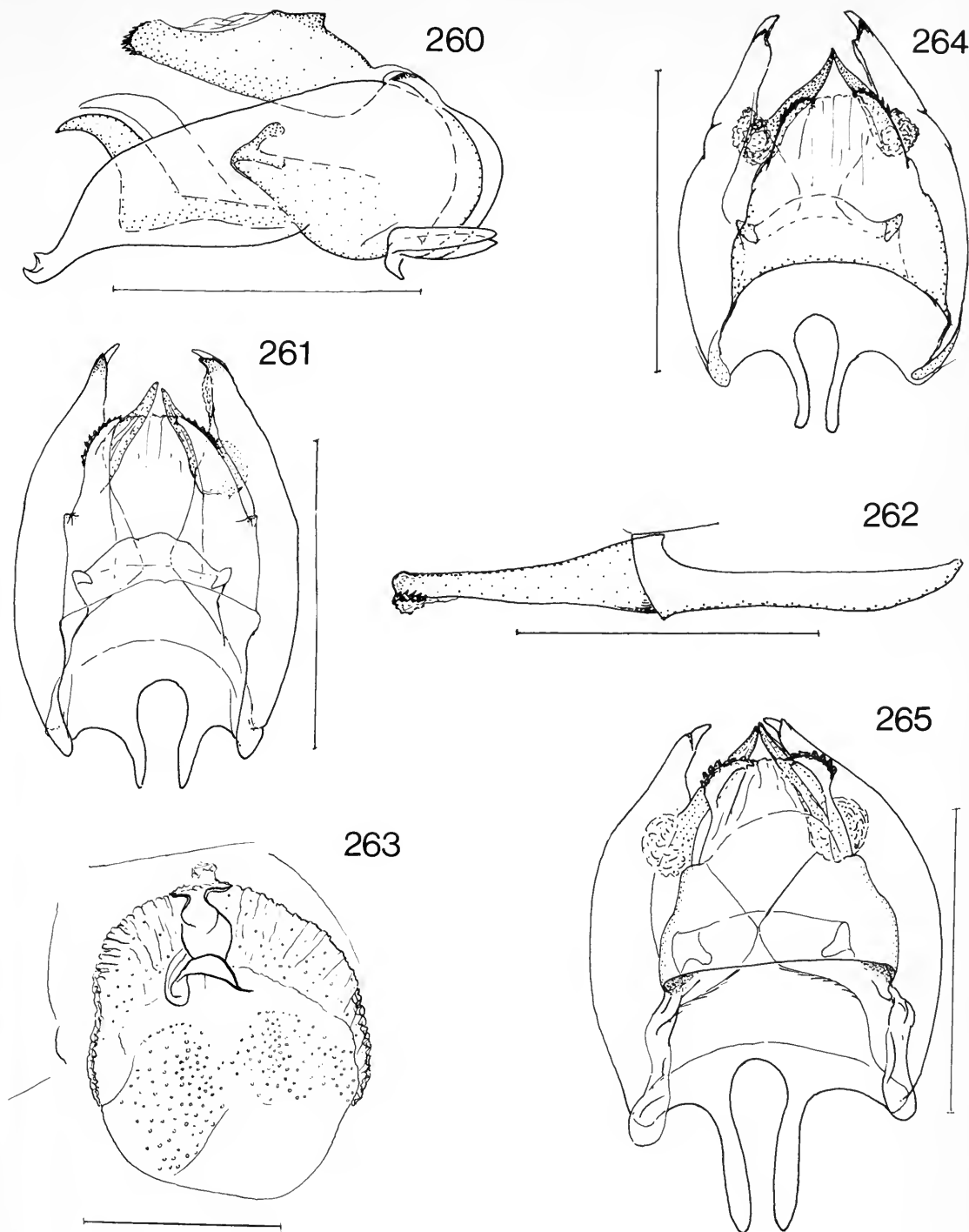

**Figs 260–265** *Anthanassa* species. (260) *A. frisia*, ♂ genitalia, lateral view, Jamaica, g/s 879; (261) *A. tulcis*, ♂ genitalia, Panama, g/s 882; (262) same, penis, Panama, g/s 882; (263) same, ♀ genitalia, Panama, g/s 117; (264) *A. dubia*, ♂ genitalia, Venezuela, San Esteban, g/s 2783; (265) *A. taeniata*, ♂ genitalia, Peru, g/s 880. Scale = 1 mm.

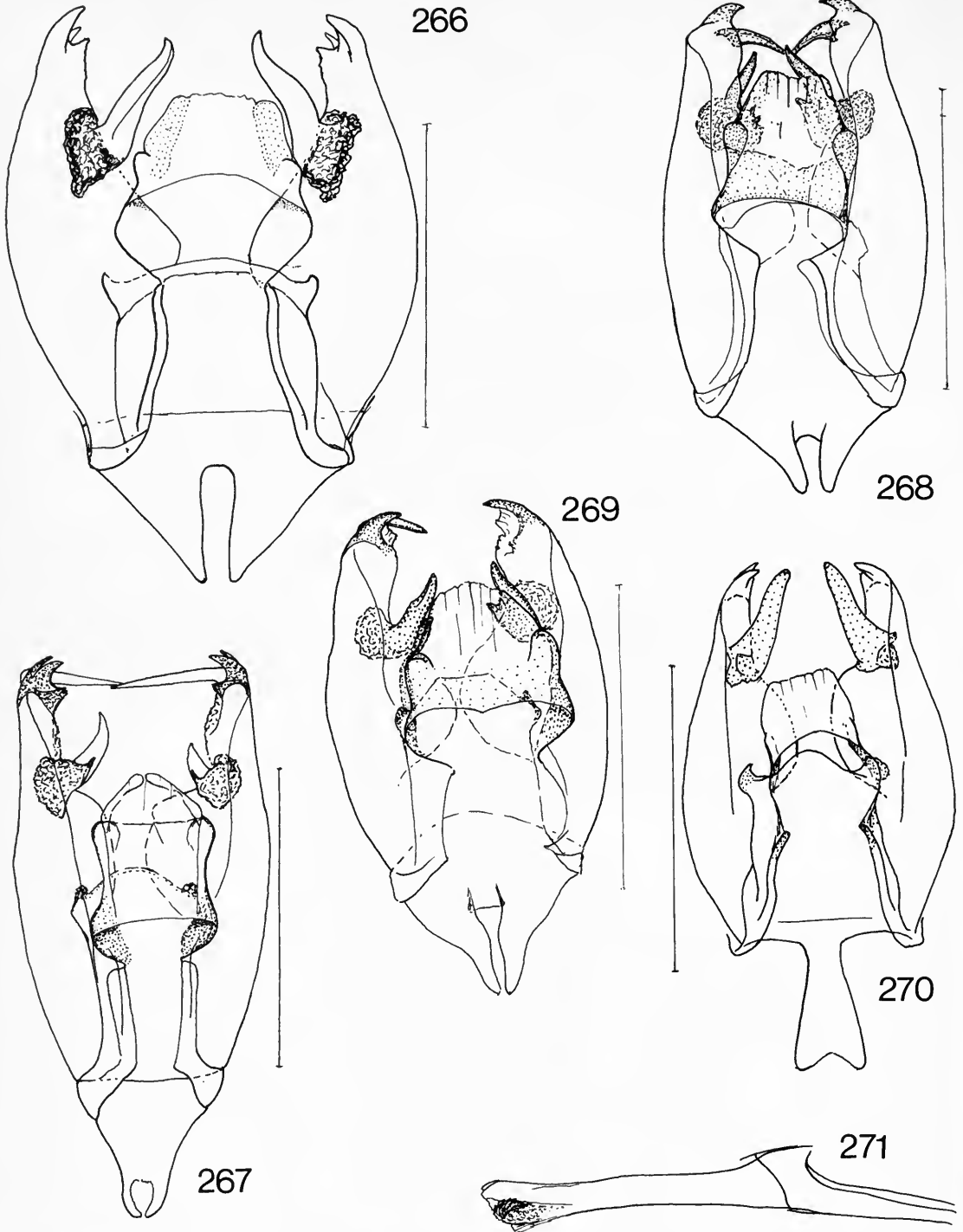

**Figs 266–271** 266–269, *Anthanassa* species. (266) *A. sosis*, ♂ genitalia, dorsal view, Panama, Chiriqui, g/s 1017; (267) *A. drymaea*, ♂ genitalia, dorsal view, Guatemala, g/s 836; (268) *A. sitalces*, ♂ genitalia, dorsal view, Guatemala, g/s 1346; (269) *A. cortes*, ♂ genitalia, Mexico, g/s 1029. 270, 271, *Dagon* species. (270) *D. pusillus*, ♂ genitalia, dorsal view, no locality, g/s 802; (271) same, penis, lateral view, no locality, g/s 802. Scale = 1 mm.



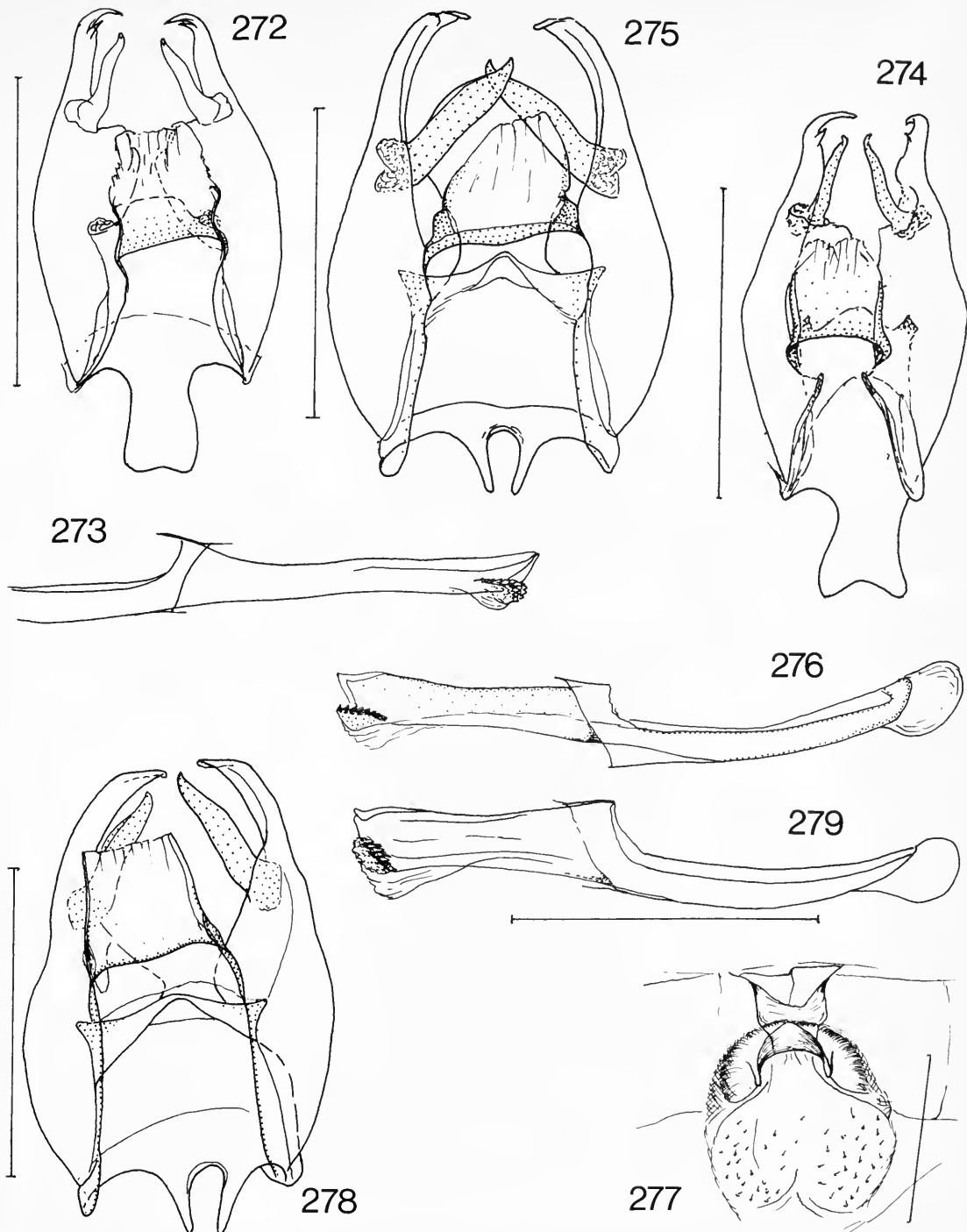

Figs 272-279 272-274, *Dagon* species. (272) *D. catula*, ♂ genitalia, dorsal view, Bolivia, g/s 812; (273) same, penis, lateral view, Bolivia, g/s 812; (274) *D. morenus*, ♂ genitalia, dorsal view, Peru, g/s 2768. 275-279, *Telenassa* species. (275) *T. teletusa*, ♂ genitalia, dorsal view, Brazil, Novo Friburgo, g/s 2563; (276) same, penis, lateral view, Brazil, Novo Friburgo, g/s 2563; (277) same, ♀ genitalia, Brazil, Tucuman, g/s 1049; (278) *T. burchelli*, ♂ genitalia, dorsal view, Peru, Chanchamayo, g/s 799; (279) same, penis, lateral view, Peru, Chanchamayo, g/s 799. Scale = 1 mm.

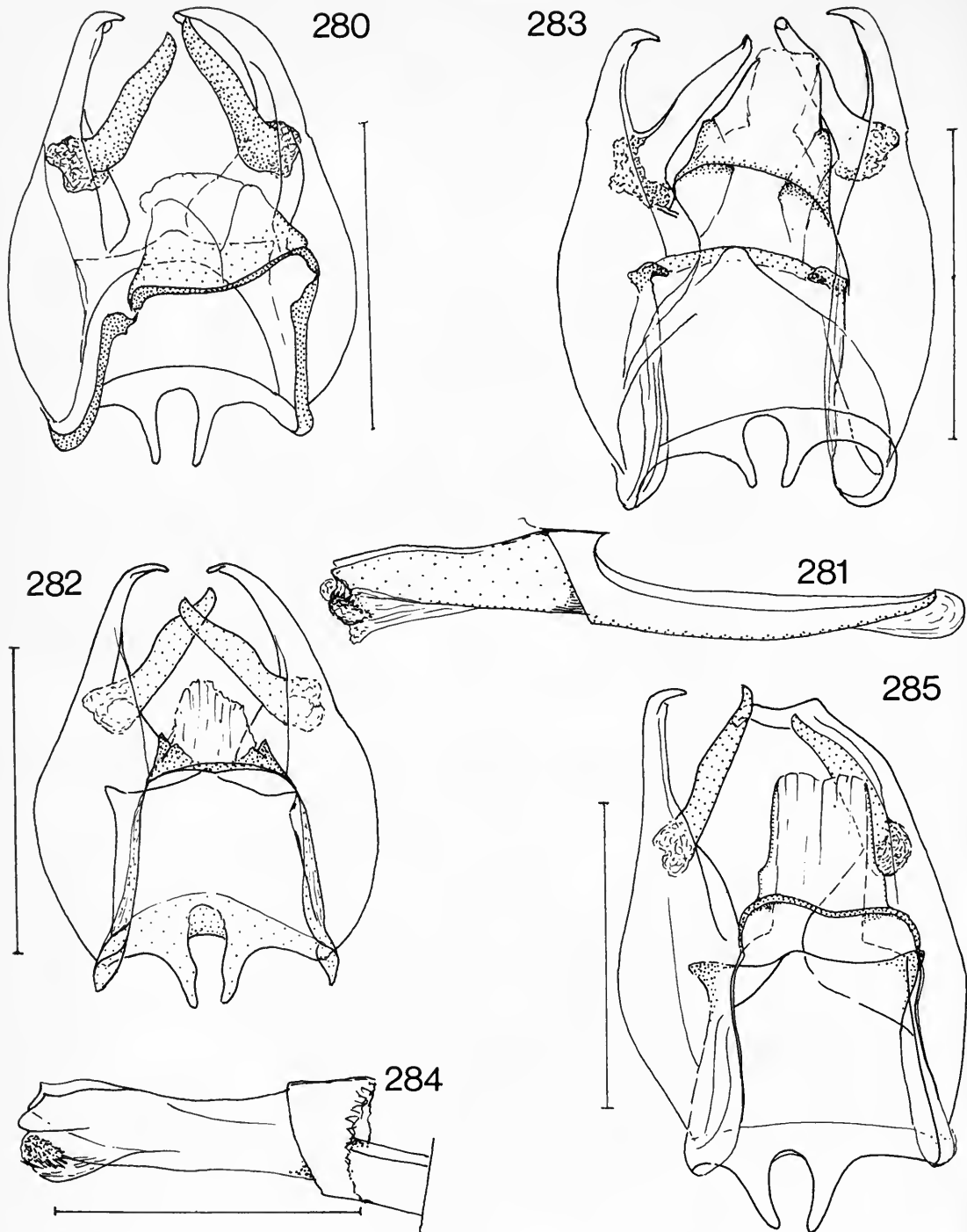

**Figs 280–285** *Telenassa* species. (280) *T. berenice*, ♂ genitalia, Peru, Amazonas, g/s 2801; (281) same, penis, Peru, g/s 936; (282) *T. signata*, ♂ genitalia, dorsal view, Argentina, Salta, g/s 2749; (283) *T. abas*, ♂ genitalia, dorsal view, Colombia, Frontino, g/s 2749; (284) same, penis, lateral view, Colombia, 'Bogota', g/s 2752; (285) *T. jana*, ♂ genitalia, dorsal view, Peru, Amazonas, g/s 109. Scale = 1 mm.

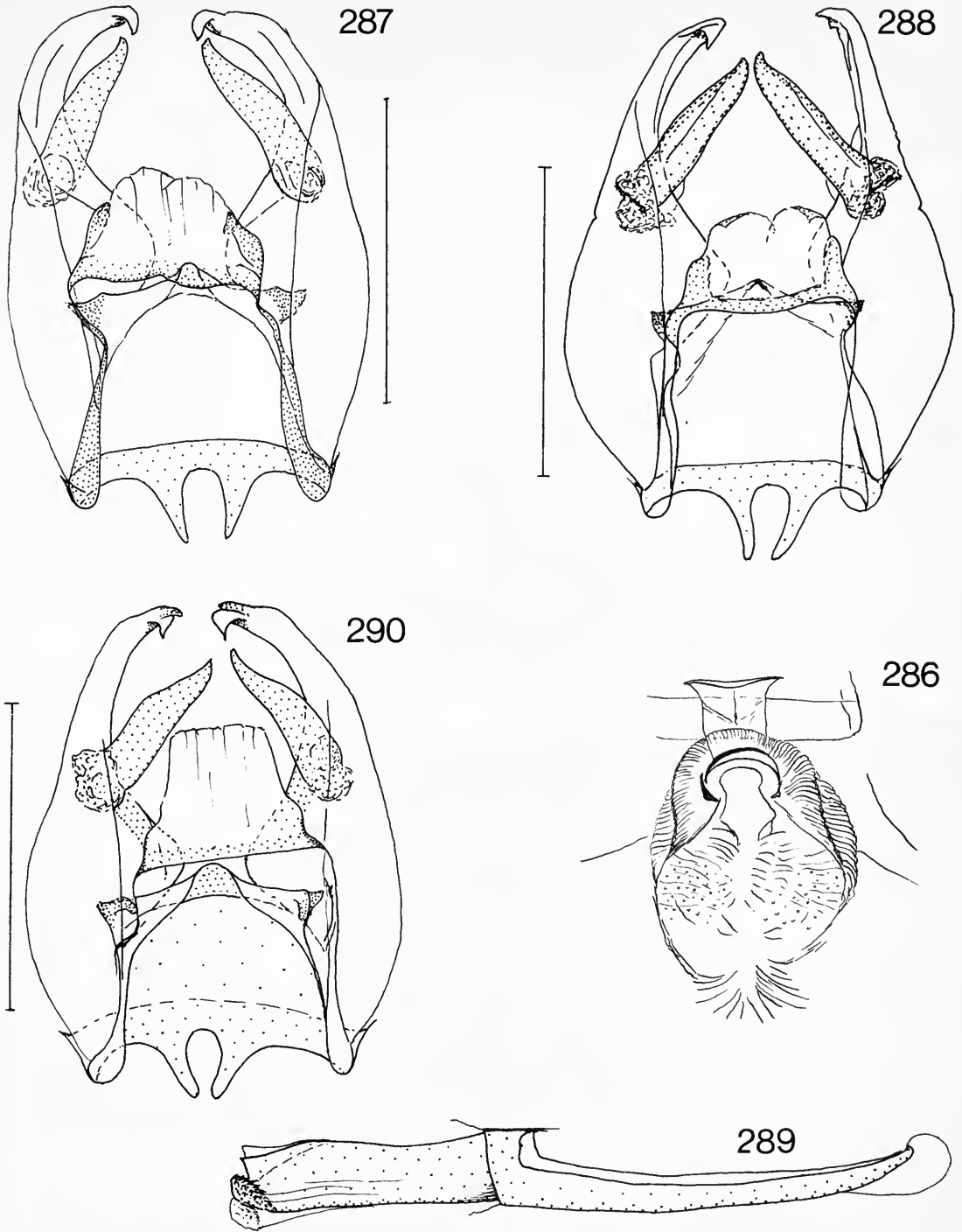

**Figs 286–290** *Telenassa* species. (286) *T. jana*, ♀ genitalia, Peru, Chachapoyas, g/s 1062; (287) *T. elaphina*, ♂ genitalia, dorsal view, Bolivia, g/s 809; (288) *T. nana*, ♂ genitalia, dorsal view, S. Peru, Cosnipata Valley, g/s 2575; (289) same, penis, lateral view, g/s 810; (290) *T. nussia*, ♂ genitalia, Peru, g/s 1028. Scale = 1 mm.

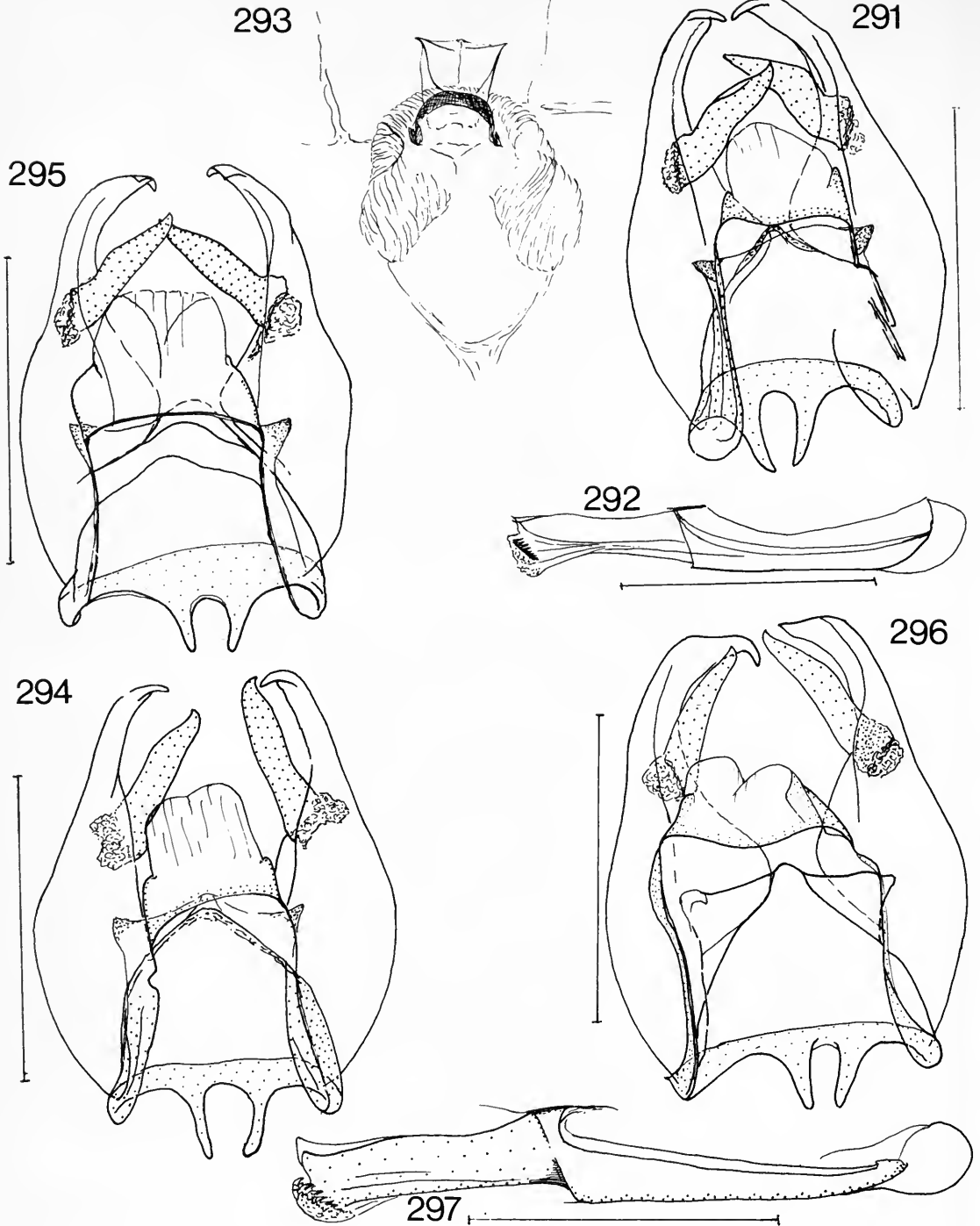

Figs 291–297 *Telenassa* species. (291) *T. notus*, ♂ genitalia, dorsal view, Peru, g/s 808; (292) same, penis, lateral view, Peru, g/s 808; (293) same, ♀ genitalia, dorsal view, Peru, g/s 1085; (294) *T. gaujoni*, ♂ genitalia, dorsal view, Ecuador, g/s 1016; (295) *T. trimaculata*, ♂ genitalia, dorsal view, Bolivia, g/s 899; (296) *T. flavocincta*, ♂ genitalia, dorsal view, Ecuador, g/s 1025; (297) same, penis, Ecuador, g/s 1025. Scale = 1 mm.

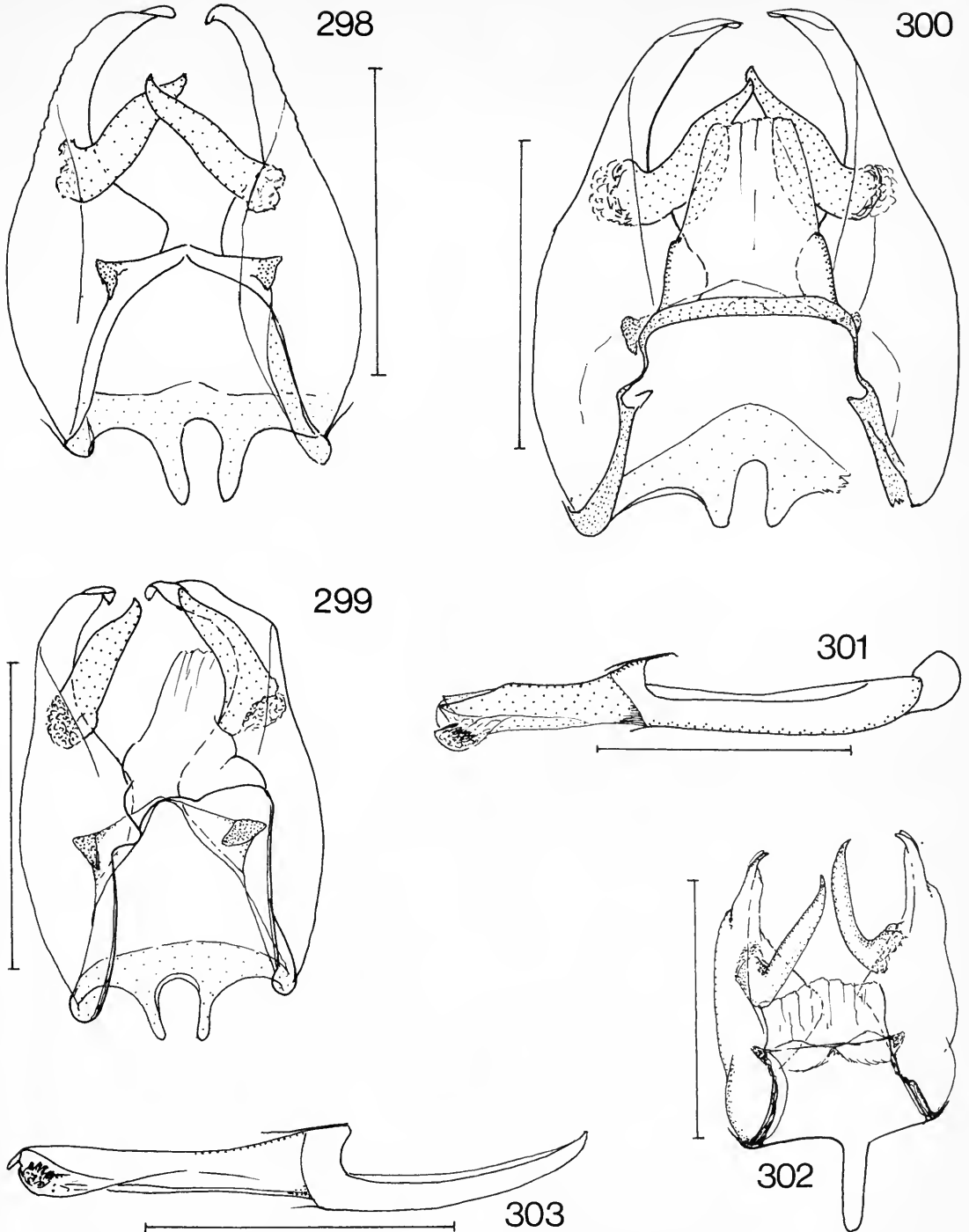

**Figs 298–303** 298–301, *Telenassa* species. (298) *T. catenariae*, ♂ genitalia (excluding tegumen), W. Colombia, g/s 2757; (299) *T. delphia*, ♂ genitalia, dorsal view, Colombia, g/s 812; (300) *T. sepulta*, ♂ genitalia, dorsal view, Peru, g/s 898; (301) same, penis, lateral view, Peru, g/s 898. 302, 303, *Ortilia* species. (302) *O. liriopae*, ♂ genitalia, dorsal view, Guyana, g/s 1559; (303) same, penis, lateral view, Brazil, Para, g/s 816. Scale = 1 mm.

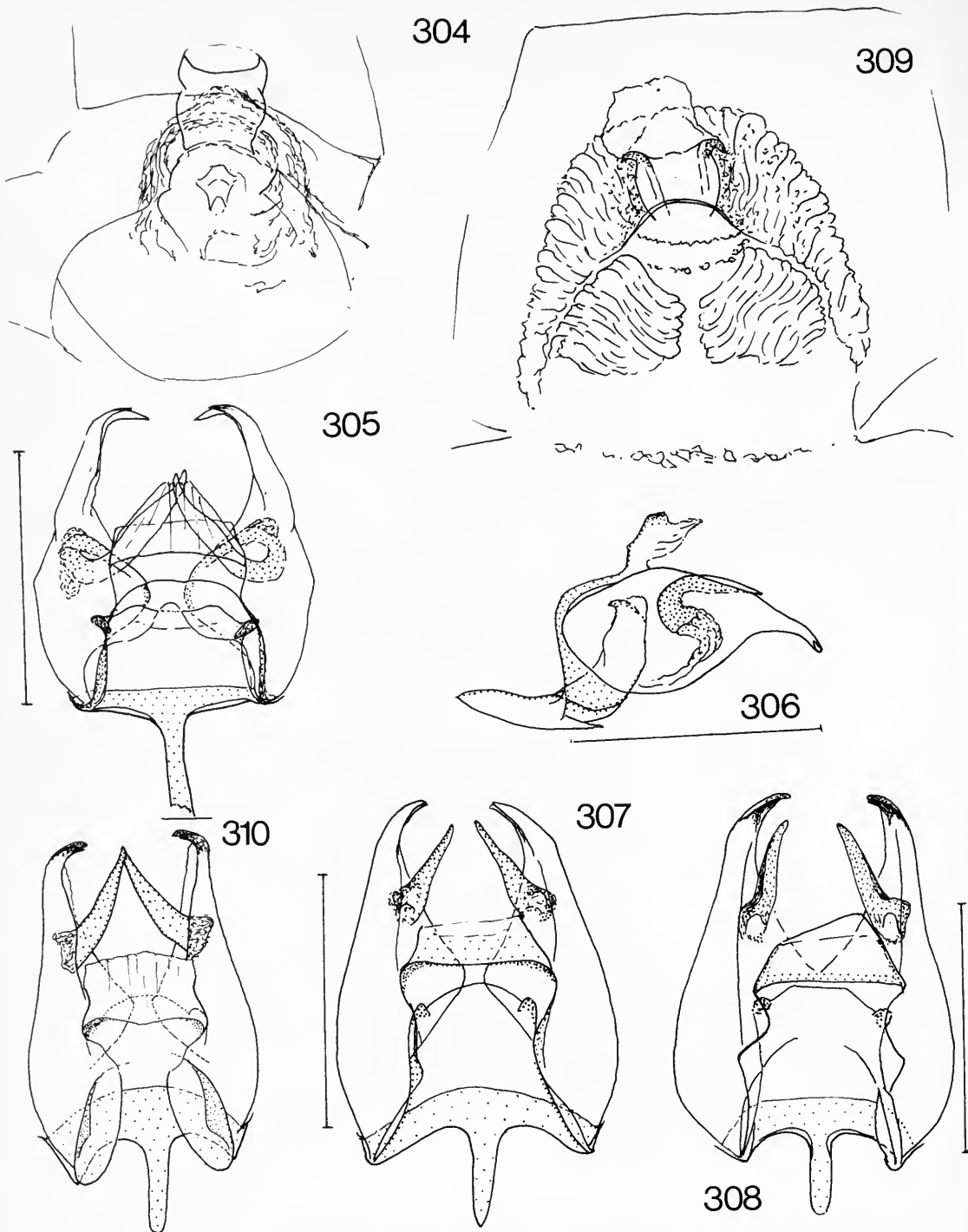

Figs 304–310 *Ortilia* species. (304) *O. liriopse*, ♀ genitalia, Lower Amazon, g/s 817; (305) *O. gentina*, ♂ genitalia, dorsal view, Bolivia, g/s 825; (306) same, ♂ genitalia, lateral view, Bolivia, g/s 1082; (307) *O. orthia*, ♂ genitalia, dorsal view, Castro, Parana, Brazil, g/s 797; (308) *O. orticas*, ♂ genitalia, dorsal view, Brazil, Parana, g/s 883; (309) same, ♀ genitalia. Brazil, g/s 1086; (310) *O. sejona*, ♂ genitalia, dorsal view, Brazil, Goias, Campinas, g/s 2800. Scale = 1 mm.

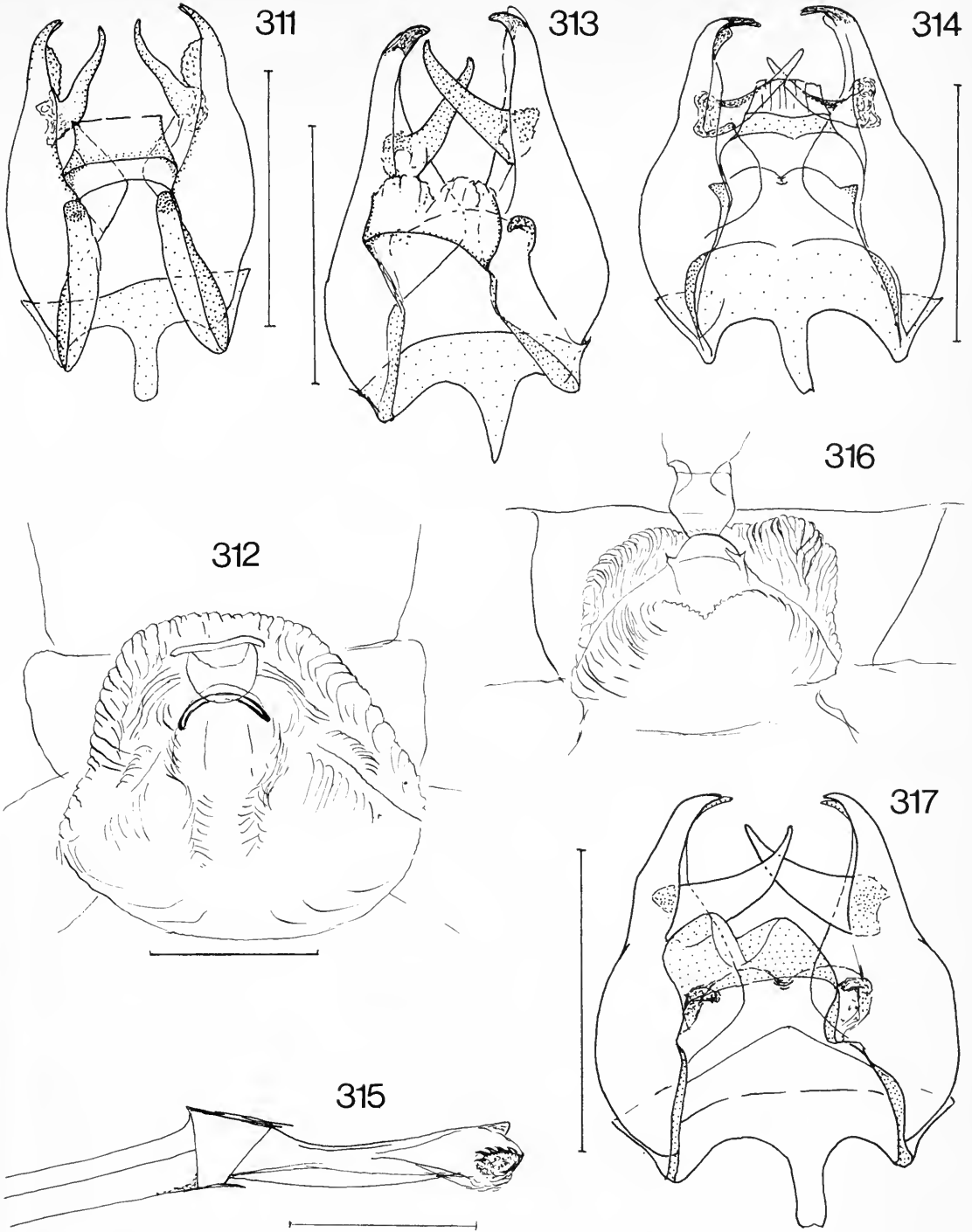

**Figs 311–317** *Ortilia* species. (311) *O. velica*, ♂ genitalia, dorsal view, Brazil, São Paulo, g/s 800; (312) *O. velica durnfordi*, ♀ genitalia, dorsal view, g/s 1090; (313) *O. zamora*, ♂ genitalia, dorsal view, Rio de Janeiro, g/s 2753; (314) *O. dicoma*, ♂ genitalia, dorsal view, Brazil, g/s 834; (315) same, penis, lateral view, Brazil, g/s 834; (316) same, ♀ genitalia, dorsal view, Brazil, g/s 1089; (317) *O. polinella*, ♂ genitalia, dorsal view, Brazil, Minas Geraes, g/s 1084. Scale = 1 mm.

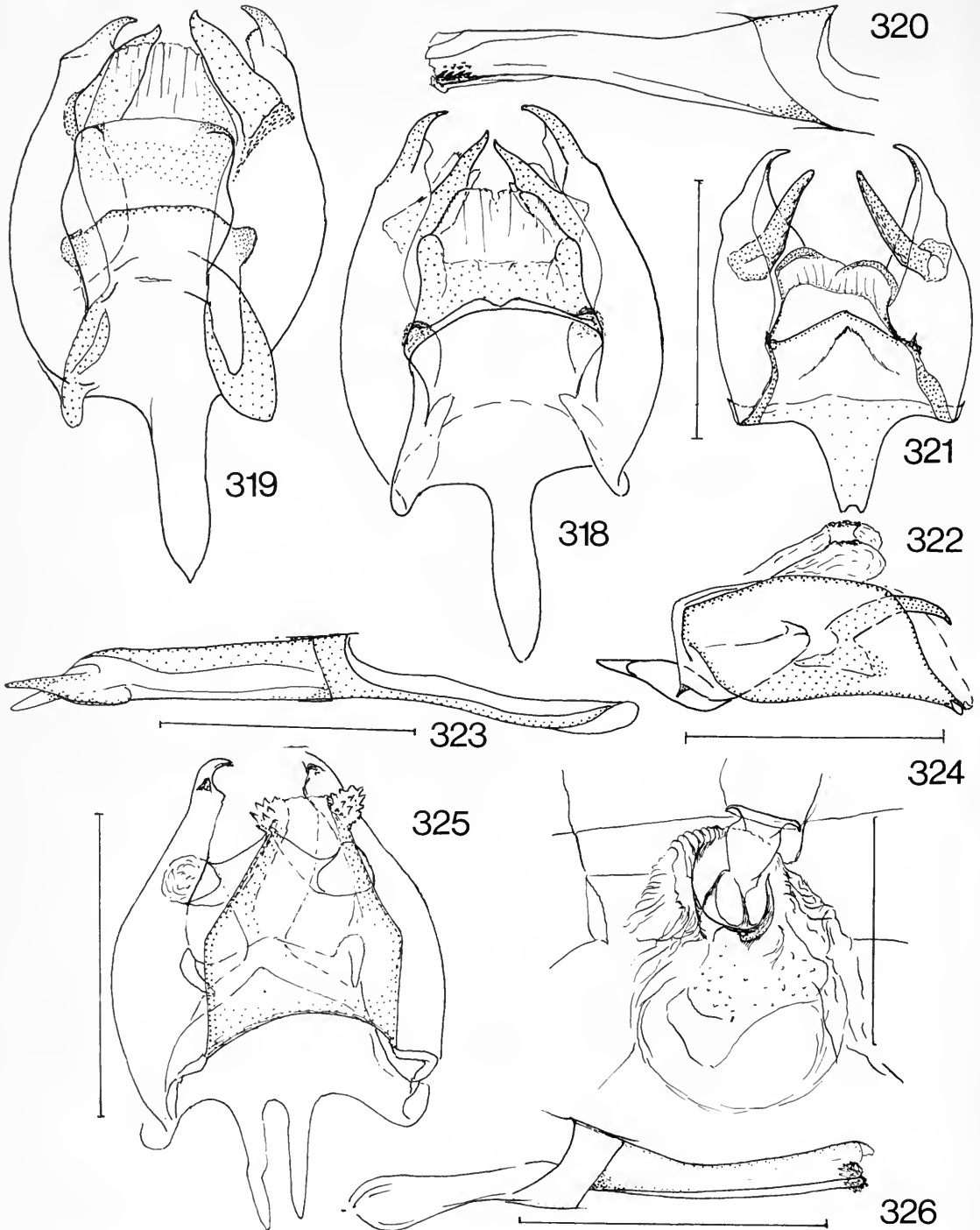

**Figs 318–326** 318–320, *Ortilia* species. (318) *O. ithra*, ♂ genitalia, dorsal view, Paraguay, g/s 853a; (319) same, ♂ genitalia, dorsal view, Brazil, Mato Grosso, g/s 853b; (320) same, penis, distal section, lateral view, Brazil, Mato Grosso, g/s 852. 321–324, *Tisona* species. (321) *T. saladillensis*, ♂ genitalia, dorsal view, Salta, g/s 878; (322) same, ♂ genitalia, lateral view, Salta, g/s 881; (323) same, penis, lateral view, Salta, g/s 878; (324) same, ♀ genitalia, Salta, g/s 1077. 325, 326, *Tegosa* species. (325) *T. claudina*, ♂ genitalia, dorsal view, Paraguay, g/s 135; (326) same, penis, lateral view, Brazil, Parana, g/s 136. Scale = 1 mm.



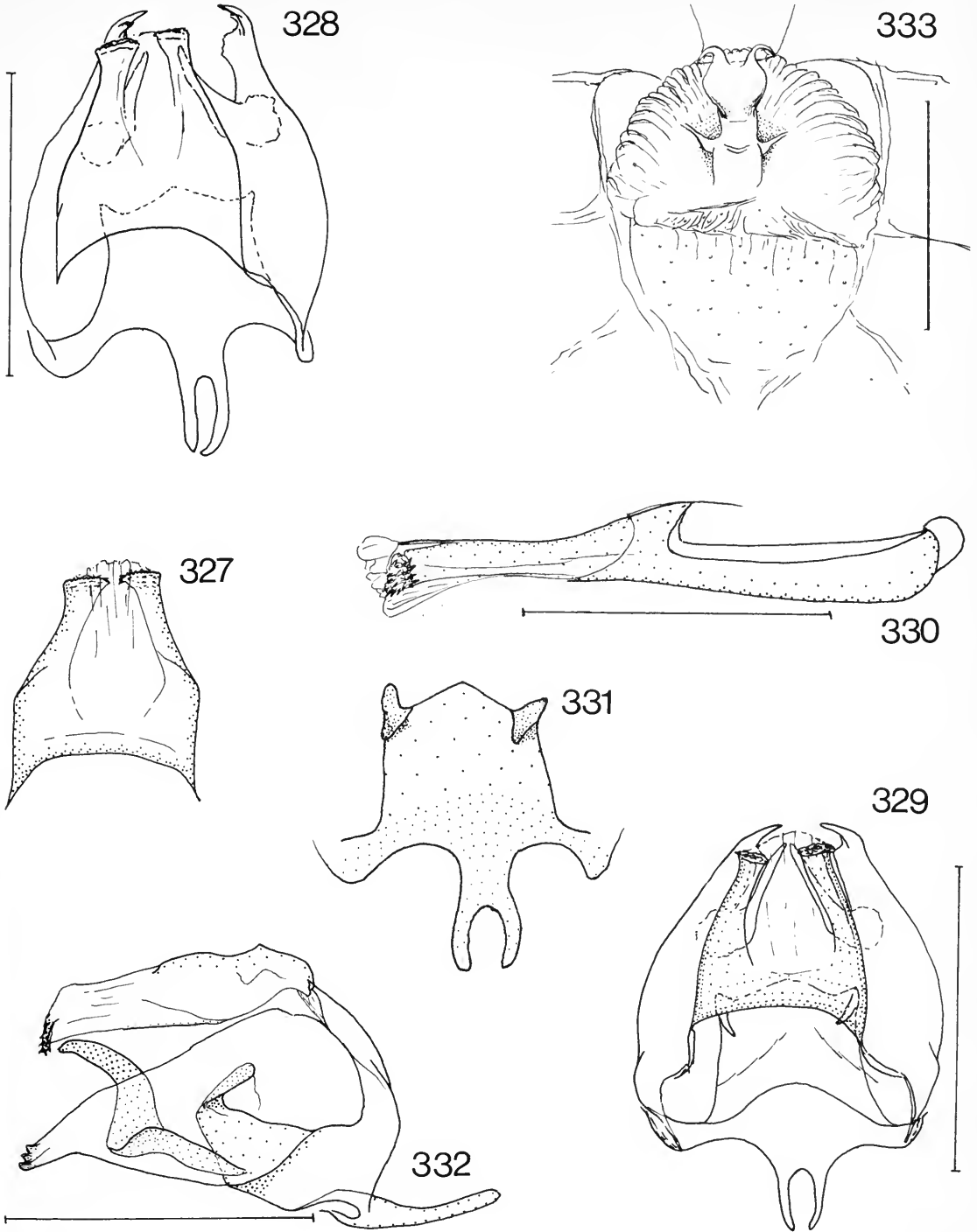

**Figs 327–333** *Tegosa* species. (327) *T. similis*, tegumen + scaphial extension, 'Indiis', lectotype, g/s 1557; (328) same, ♂ genitalia, 'Indiis', lectotype, g/s 1557; (329) same, ♂ genitalia, Trinidad, g/s 893; (330) same, penis, lateral view, Brazil, g/s 2700; (331) same, saccus and tegumen + scaphial extension, Brazil, g/s 2700; (332) same, ♂ genitalia, lateral view, Brazil, Minas Geraes, g/s 2700; (333) same, ♀ genitalia, Brazil, g/s 1080. Scale = 1 mm.

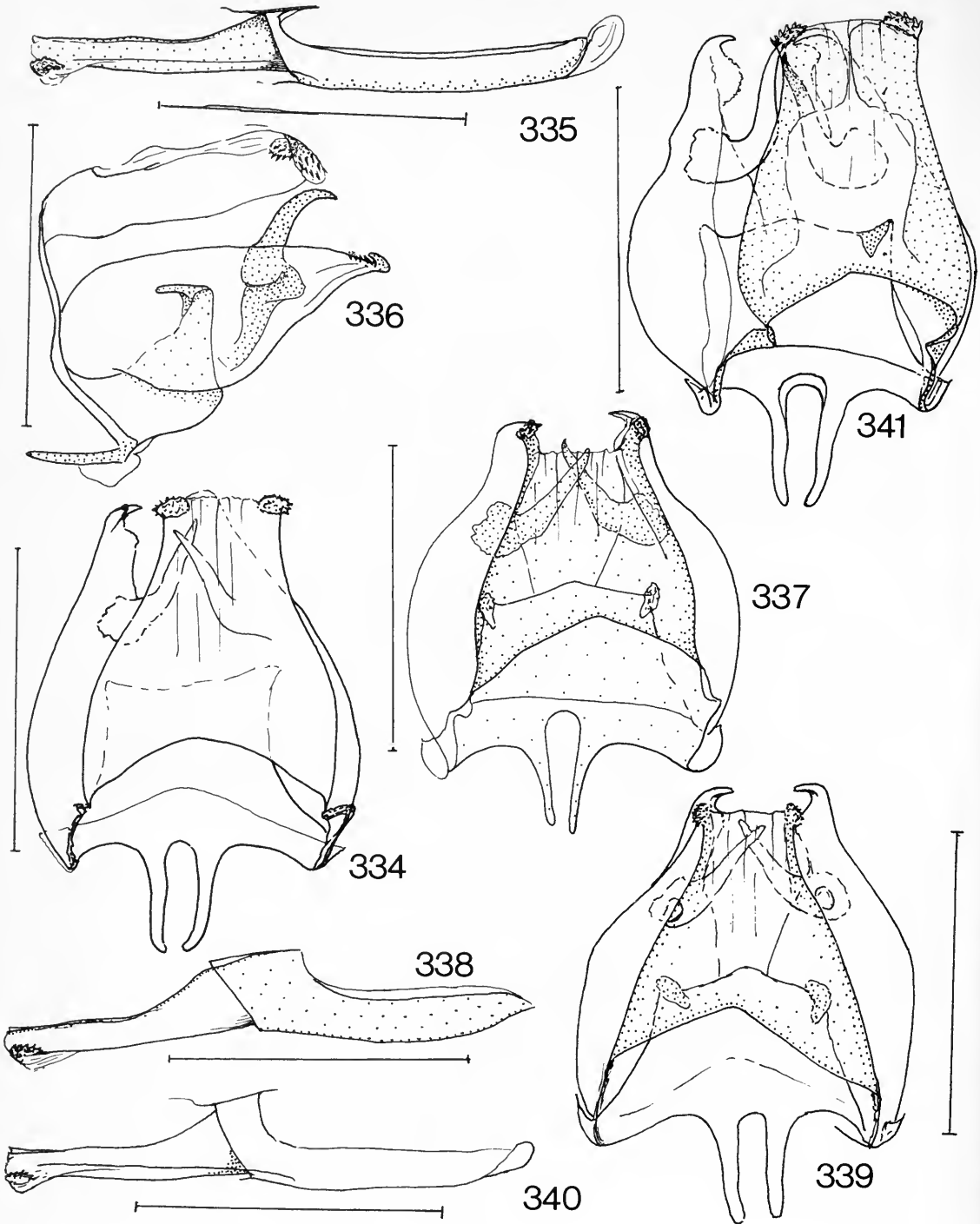

Figs 334–341 *Tegosa* species. (334) *T. orobia*, ♂ genitalia, Brazil, Castro, Parana, g/s 892; (335) same, penis, lateral view, Brazil, Castro, Parana, g/s 892; (336) same, ♂ genitalia, lateral view, g/s 1073; (337) *T. fragilis*, ♂ genitalia, dorsal view, 'Brazil', g/s 2595; (338) same, penis, lateral view, 'Brazil', g/s 2595; (339) *T. infrequens*, ♂ genitalia, dorsal view, Bolivia, g/s 2714; (340) same, penis, lateral view, Bolivia, g/s 2714; (341) *T. ursula*, ♂ genitalia, Argentina, Tucuman, g/s 888. Scale = 1 mm.

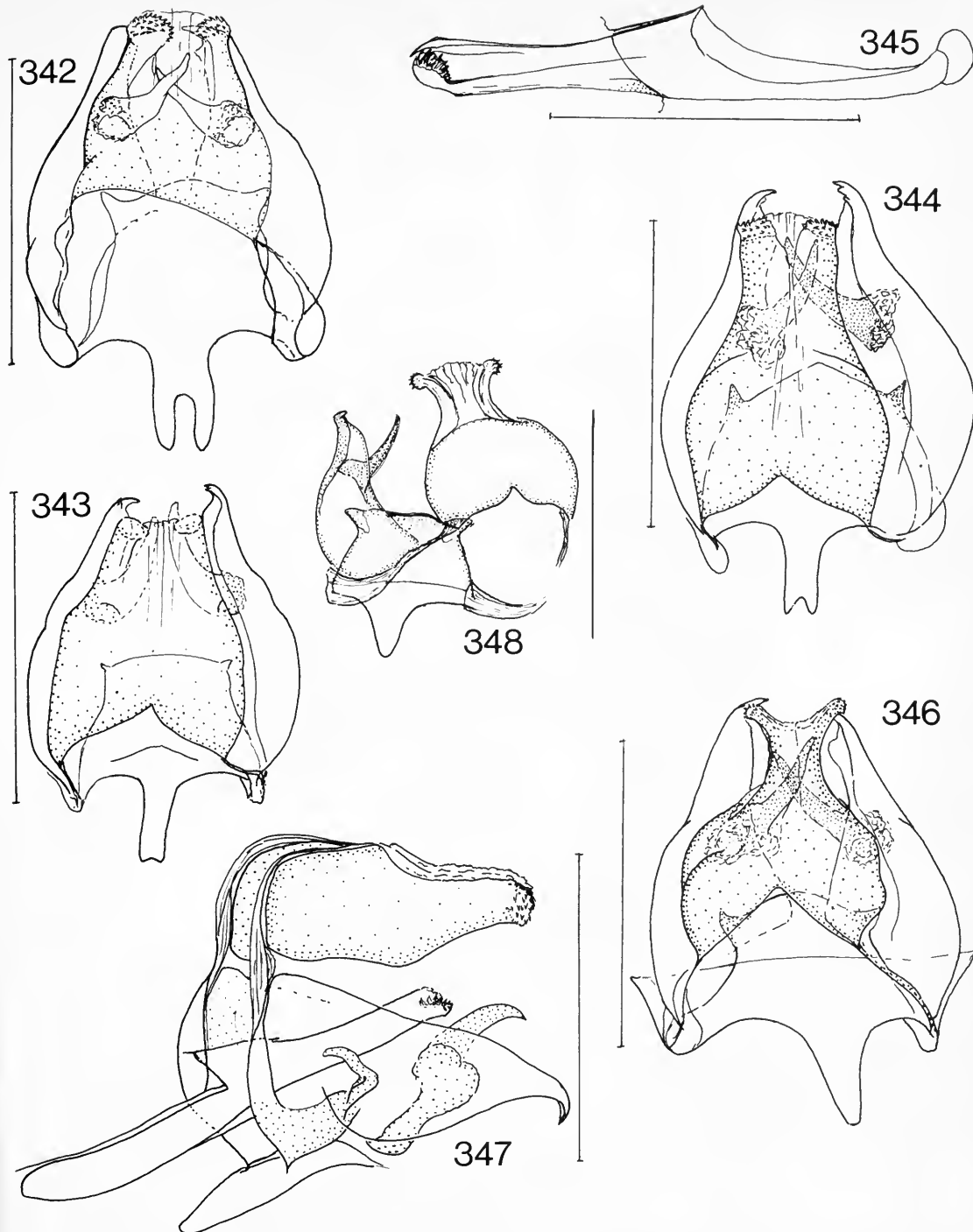

**Figs 342–348** *Tegosa* species. (342) *T. flavida*, ♂ genitalia, dorsal view, Ecuador, g/s 2583; (343) *T. tissoides*, ♂ genitalia, Ecuador, g/s 1117; (344) *T. pastazena*, ♂ genitalia, Peru, Pozuzo, Huanuco, g/s 827; (345) same, penis, lateral view, Peru, Pozuzo, Huanuco, g/s 827; (346) *T. guatemalena*, ♂ genitalia, dorsal view, Guatemala, g/s 2590; (347) same, ♂ genitalia, lateral view, Mexico, Oaxaca, g/s 1193; (348) same, ♂ genitalia with tegumen displaced and right valve omitted, Mexico, g/s 125. Scale = 1 mm.

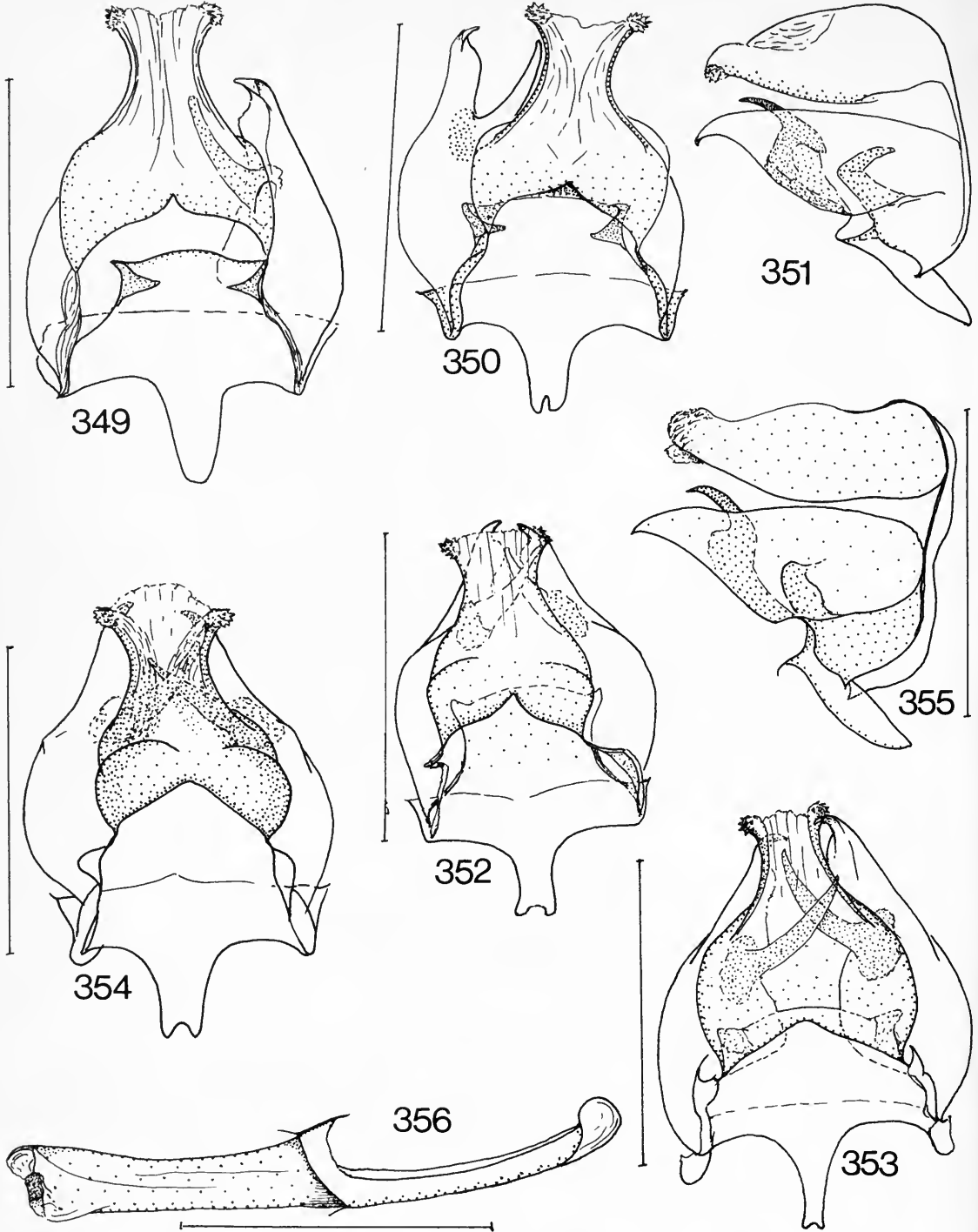

Figs 349–356 *Tegosa* species. (349) *T. anieta anieta*, ♂ genitalia, Panama, g/s 1020; (350) same, ♂ genitalia, Peru, g/s 1072; (351) same, ♂ genitalia, lateral view, Venezuela, Caracas, g/s 1202; (352) *T. anieta cluvia*, ♂ genitalia, Guatemala, g/s 1116; (353) *T. anieta luka*, ♂ genitalia, Mexico, g/s 2596; (354) same, ♂ genitalia, Ecuador, g/s 855; (355) *T. anieta anieta*, ♂ genitalia, lateral view, Venezuela, g/s 876; (356) same, penis, Panama, Onaca, g/s 839. Scale = 1 mm.

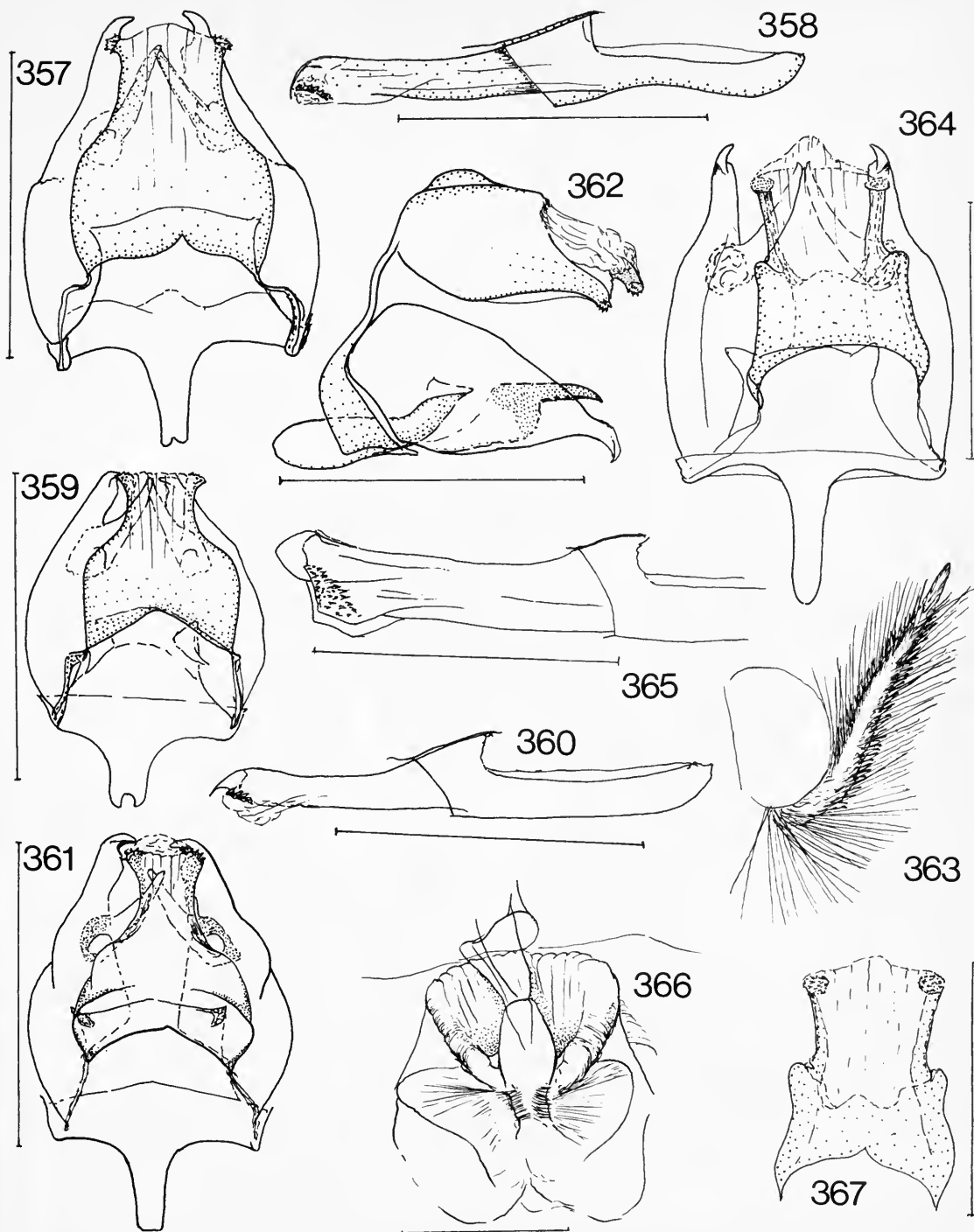

**Figs 357–367** 357–363, *Tegosa* species. (357) *T. nazaria*, ♂ genitalia, Colombia, g/s 877; (358) same, penis, lateral view, Colombia, g/s 877; (359) *T. etia*, ♂ genitalia, Guatemala, g/s 1125; (360) same, penis, lateral view, Guatemala, g/s 1125; (361) *T. nigrella*, ♂ genitalia, dorsal view, Costa Rica, g/s 2571; (362) same, ♂ genitalia, lateral view, Costa Rica, g/s 831; (363) same, side view of palpus. 364–367 *Eresia* species. (364) *E. clara*, ♂ genitalia, Venezuela, g/s 2559; (365) same, penis, Ecuador, g/s 2559 (2); (366) same, ♀ genitalia, Mexico, g/s 1061; (367) *E. clara* f. *reducta*, tegumen, g/s 2559 (1). Scale = 1 mm.

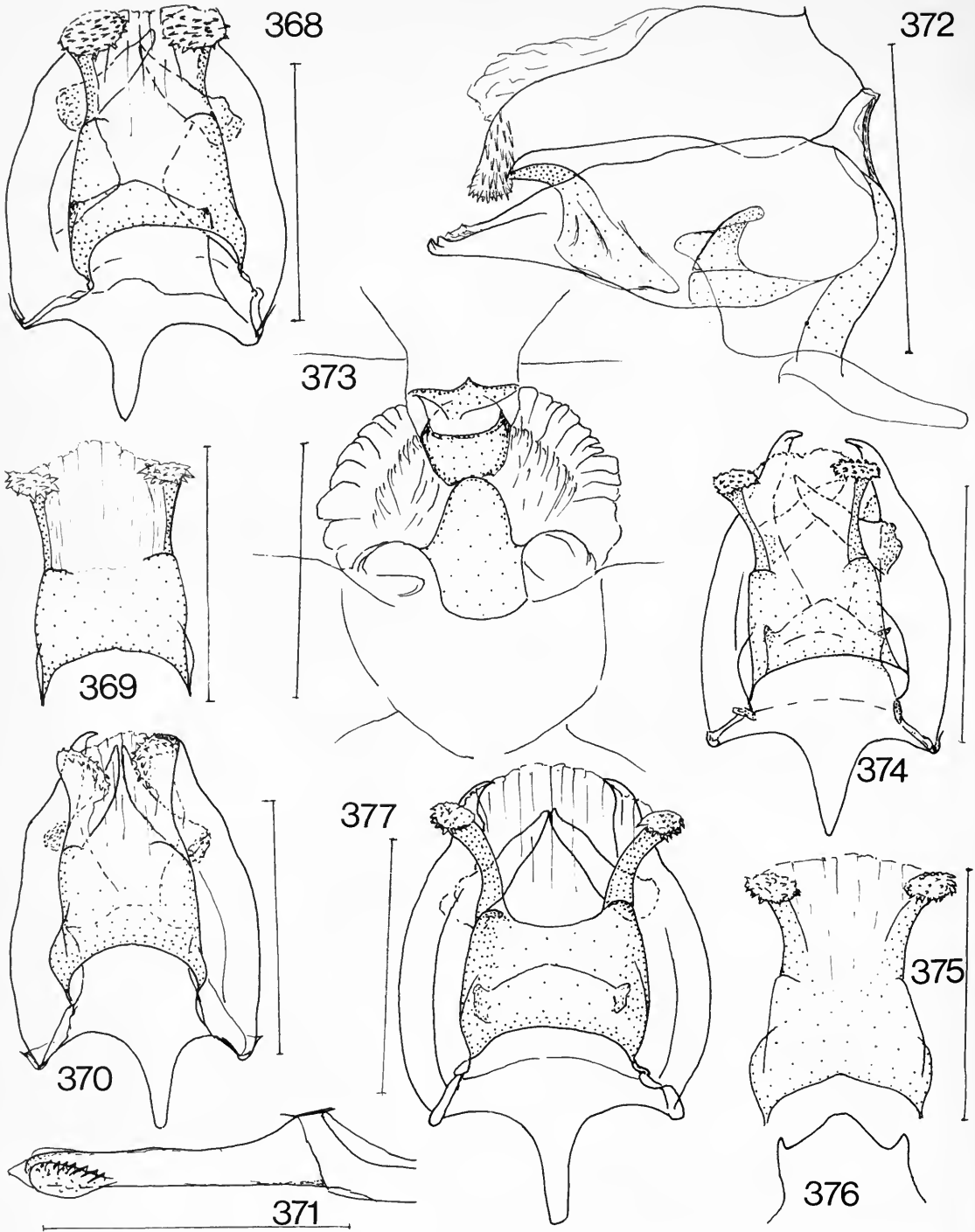

Figs 368–377 *Eresia* species. (368) *E. nauplius nauplius*, ♂ genitalia, dorsal view, Brazil, Obidos, g/s 2726; (369) same, tegumen, Brazil, Obidos, g/s 2742 (1); (370) same, ♂ genitalia, dorsal view, Guyana, g/s 636; (371) same, penis, distal section, lateral view, French Guiana, g/s 2584; (372) same, ♂ genitalia, lateral view, Guyana, g/s 2733; (373) same, ♀ genitalia, dorsal view, Brazil, Obidos, g/s 2734; (374) same, ♂ genitalia, dorsal view, 'Brazil', g/s 2736; (375) *E. plagiata*, dorsal structures, Brazil, Cucaru, g/s 2742 (2); (376) same, juxta, Brazil, Cucaru, g/s 2742(2); (377) same, ♂ genitalia, dorsal view, Peru, g/s 2560. Scale = 1 mm.

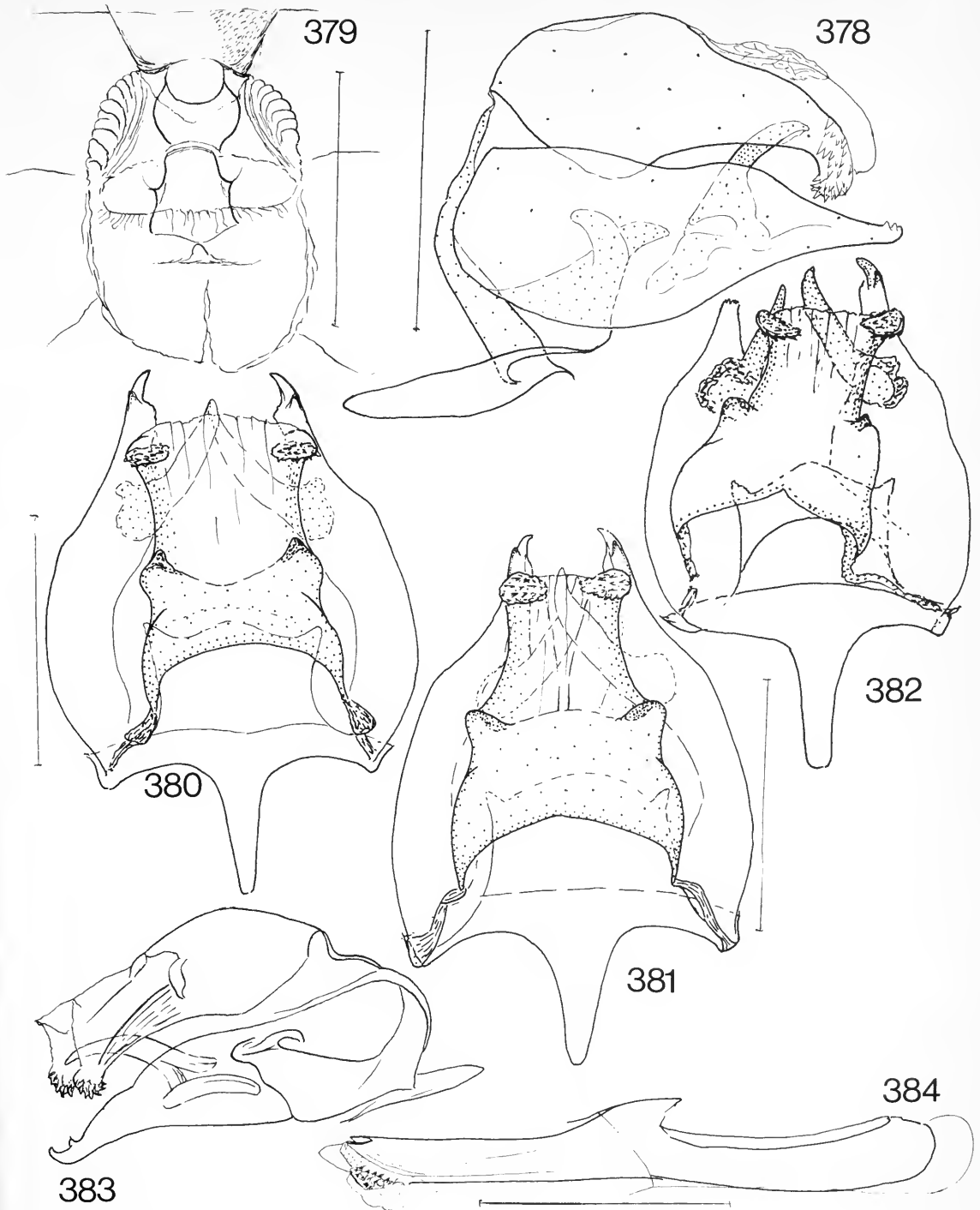

Figs 378–384 *Eresia* species. (378) *E. plagiata*. ♂ genitalia, lateral view, Brazil, Teffe, g/s 2737; (379) same, ♀ genitalia, Brazil, g/s 637; (380) *E. letitia ocellata (neptoides)*, ♂ genitalia, dorsal view, Peru, g/s 1244; (381) *E. letitia ocellata (nigra)*, ♂ genitalia, dorsal view, Peru, g/s 91; (382) *E. letitia letitia*, ♂ genitalia, dorsal view, Ecuador, g/s 2782; (383) *E. letitia ocellata*, ♂ genitalia, lateral view, Peru, g/s 186; (384) *E. letitia*, penis, lateral view, g/s 1242. Scale = 1 mm.

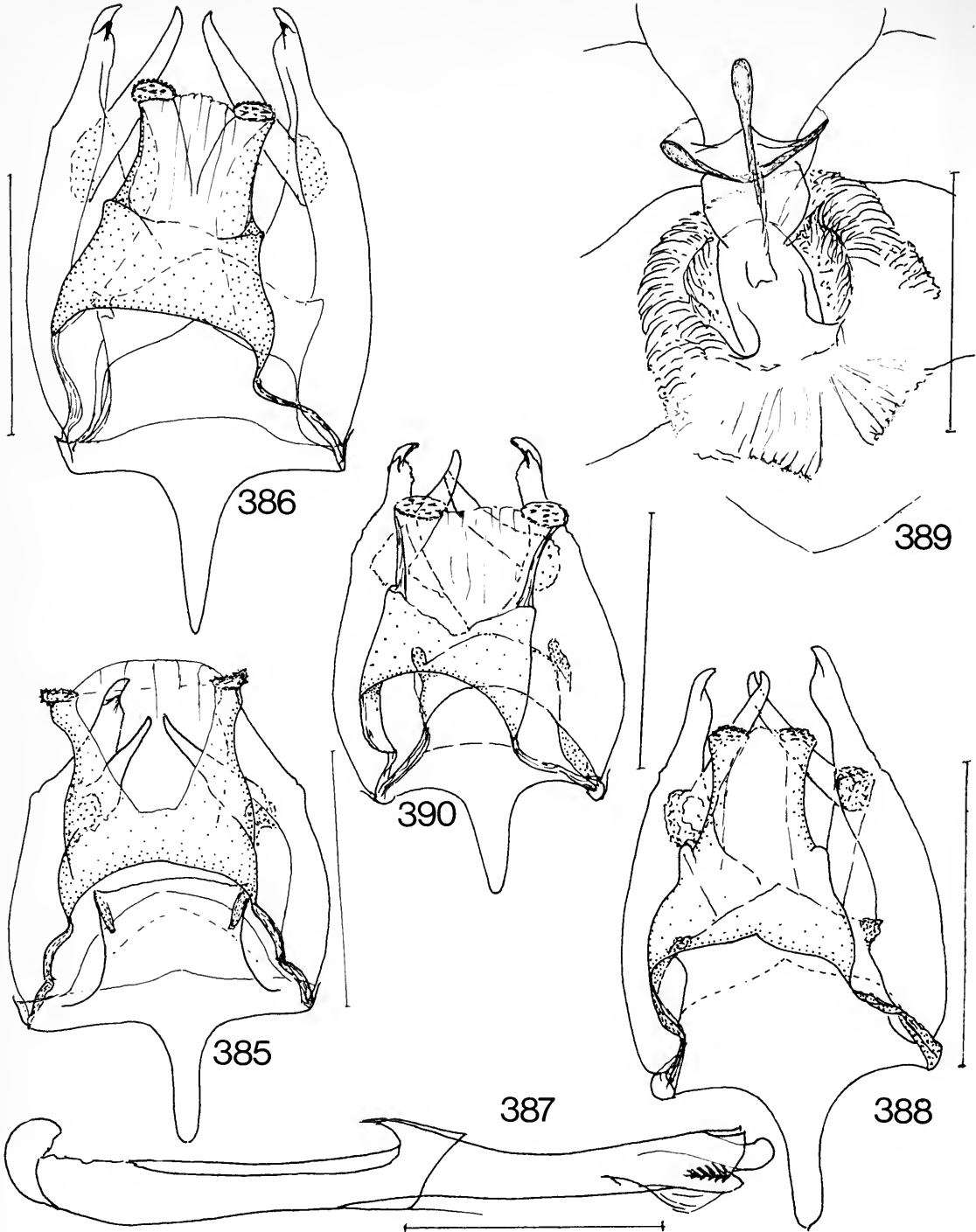

**Figs 385–390** *Eresia* species. (385) *E. lansdorfi*, ♂ genitalia, dorsal view, Brazil, g/s 92; (386) *E. sestia*, ♂ genitalia, dorsal view, Ecuador, g/s 633; (387) same, penis lateral view, Ecuador, g/s 2713; (388) *E. coela*, ♂ genitalia, dorsal view, Costa Rica, g/s 2790; (389) same, ♀ genitalia, g/s 2740; (390) *E. oblita*, genitalia, dorsal view, Venezuela, g/s 2769. Scale = 1 mm.



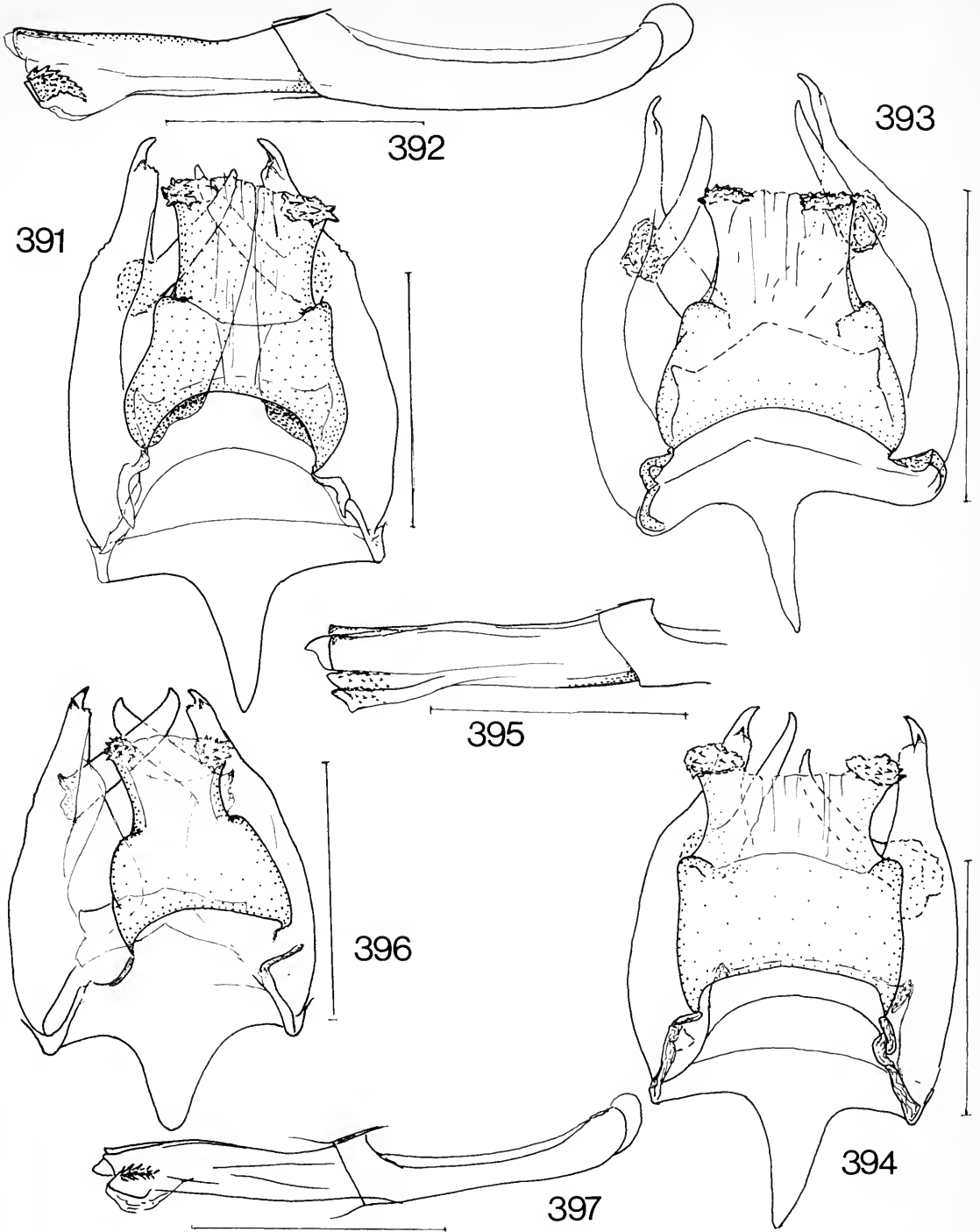

**Figs 391–397** *Eresia* species. (391) *E. carne carne*, ♂ genitalia, dorsal view, Colombia, g/s 1241; (392) same, penis, lateral view, Colombia, g/s 1241; (393) same, ♂ genitalia, dorsal view, W. Colombia, g/s 2723 (2); (394) *E. polina*, ♂ genitalia, dorsal view, Colombia, g/s 89; (395) same, penis, lateral view, Colombia, g/s 89; (396) *E. alsina*, ♂ genitalia, dorsal view, Costa Rica, g/s 628; (397) same, penis, lateral view, Costa Rica, g/s 628. Scale = 1 mm.

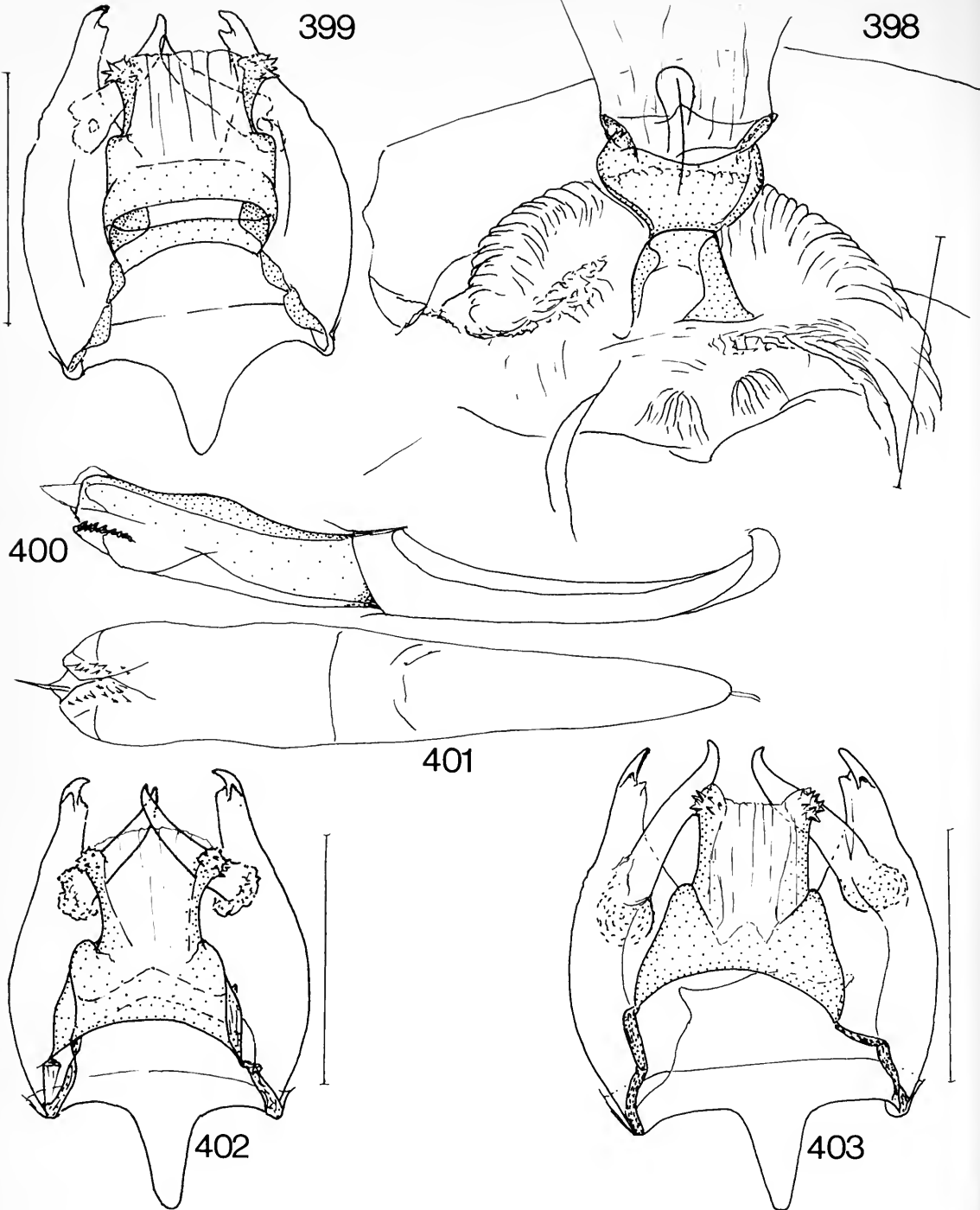

Figs 398–403 *Eresia* species. (398) *E. alsina*, ♀ genitalia, Nicaragua, g/s 629; (399) *E. cissia*, ♂ genitalia, dorsal view, W. Colombia, g/s 2771; (400) same, penis, lateral view, W. Colombia, g/s 2771; (401) same, penis, dorsal view, W. Colombia, g/s 2771; (402) *E. eutropia*, ♂ genitalia, dorsal view, W. Colombia, g/s 630; (403) *E. quintilla*, ♂ genitalia, dorsal view, Ecuador, g/s 631. Scale = 1 mm.

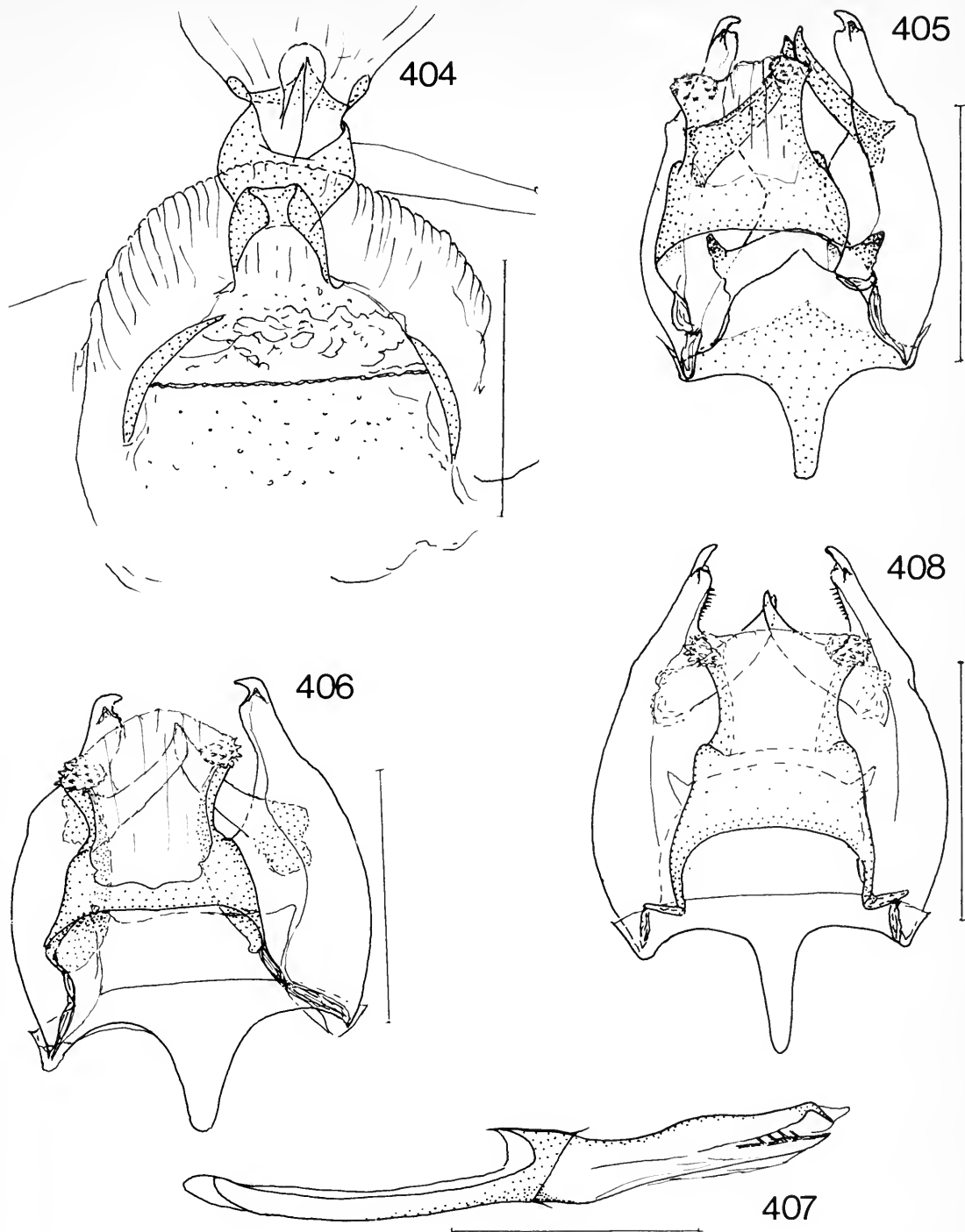

Figs 404–408 *Eresia* species. (404) *E. quintilla*, ♀ genitalia, Ecuador, g/s 632; (405) *E. sticta*, ♂ genitalia, dorsal view, Costa Rica, g/s 1023; (406) *E. ithomioides*, ♂ genitalia, dorsal view, Colombia, g/s 1240; (407) same, penis, lateral view, Colombia, g/s 1240; (408) *E. nigripennis*, ♂ genitalia, dorsal view, Costa Rica, g/s 896. Scale = 1 mm.

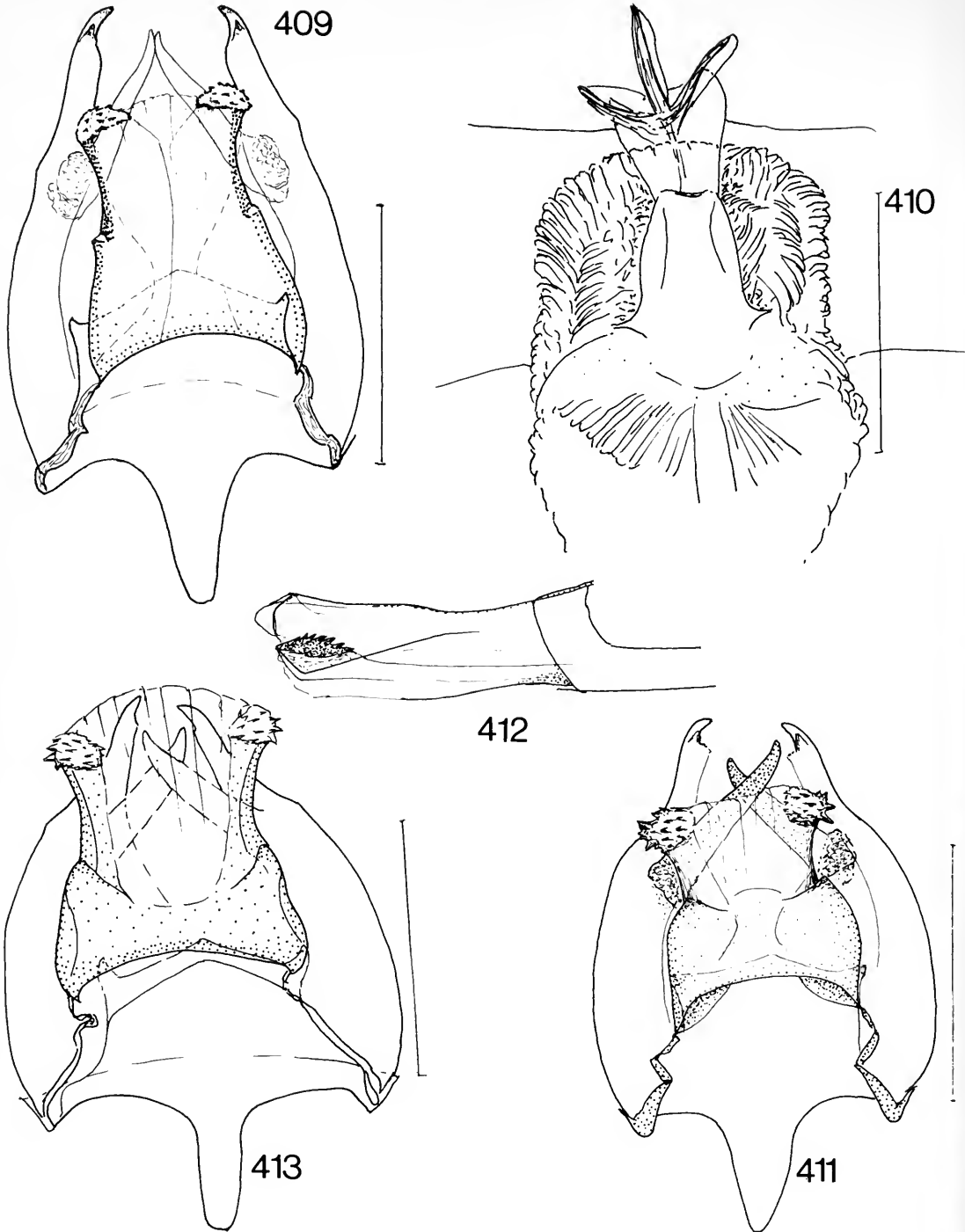

**Figs 409–413** *Eresia* species. (409) *E. emerantia*, ♂ genitalia, dorsal view, Colombia, nr Larogosa, g/s 620; (410) same, ♀ genitalia, Colombia, g/s 2740; (411) *E. moesta*, ♂ genitalia, no locality [Ecuador?], g/s 2793; (412) same, penis, no locality [Ecuador?], g/s 2793; (413) *E. phaedima*, ♂ genitalia, Peru, g/s 639. Scale = 1 mm.

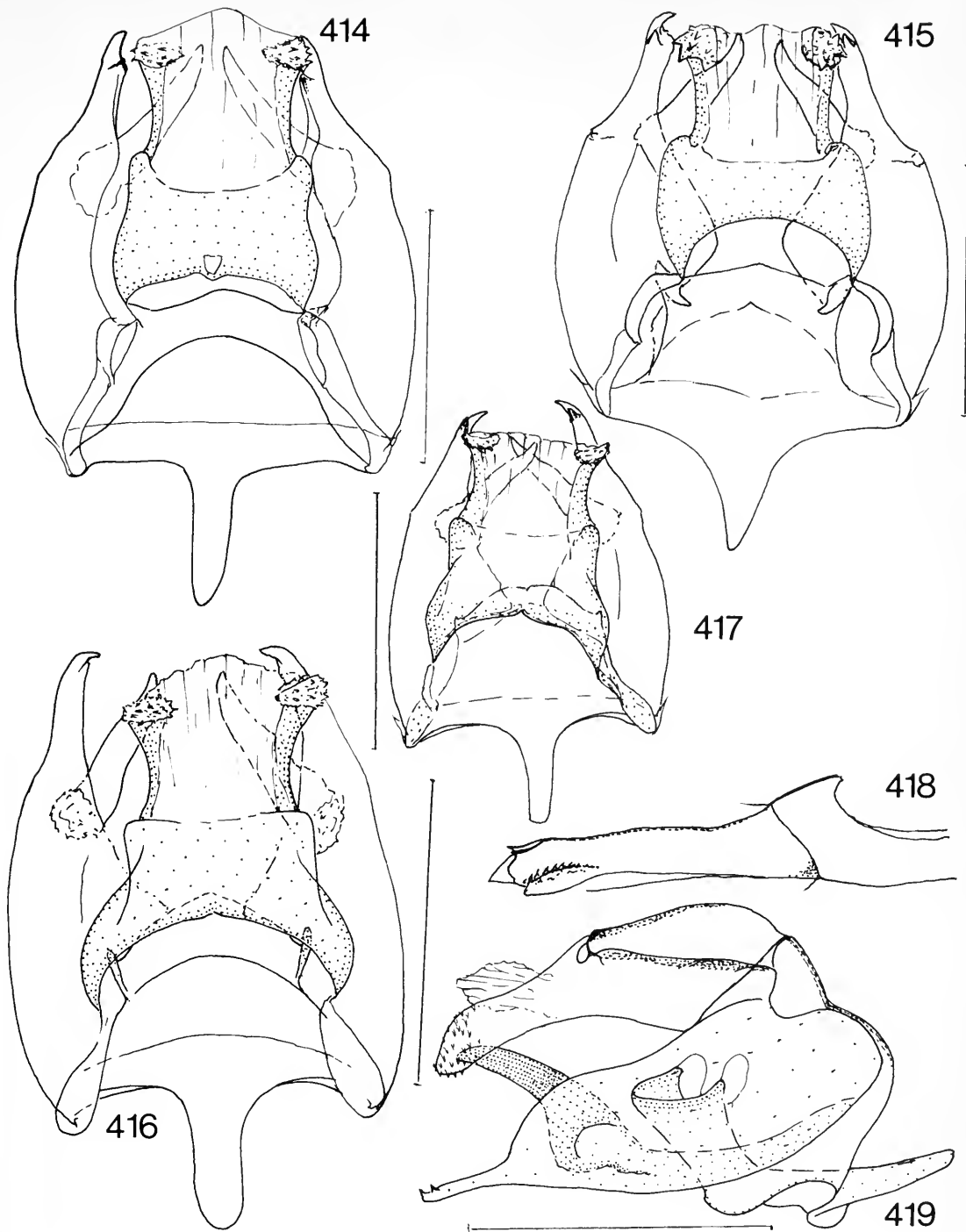

Figs 414–419 *Eresia* species. (414) *E. datis corybassa*, ♂ genitalia, dorsal view, Bolivia, g/s 622; (415) *E. margaretha*, ♂ genitalia, dorsal view, Colombia, g/s 2718; (416) *E. eunice*, ♂ genitalia, dorsal view, Peru, g/s 897; (417) *E. eunice esora*, ♂ genitalia, Brazil, São Paulo, g/s 2717; (418) *E. eunice eunice*, penis, lateral view, Brazil, g/s 1265; (419) same, ♂ genitalia, lateral view, Peru, g/s 2561. Scale = 1 mm.

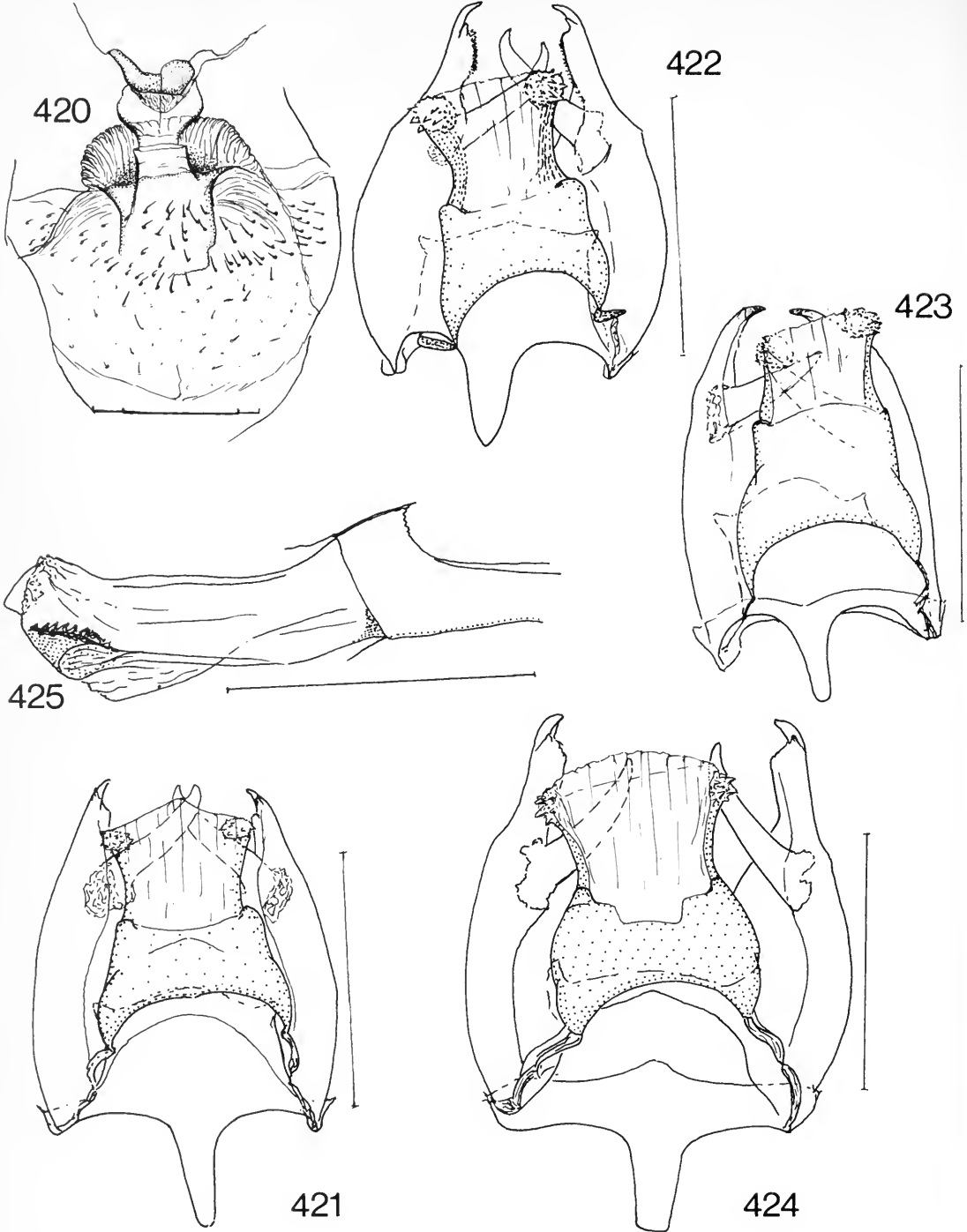

Figs 420–425 *Eresia* species. (420) *E. eunice eunice*, ♀ genitalia, Peru, g/s 1048; (421) *E. etesia*, ♂ genitalia, French Guiana, g/s 1026; (422) *E. casiphia*, ♂ genitalia, dorsal view, Ecuador, g/s 1027; (423) *E. mechanitis*, ♂ genitalia, dorsal view, Nicaragua, g/s 1243; (424) *E. pelonia*, ♂ genitalia, dorsal view, Brazil, g/s 92; (425) same, penis, lateral view, Ecuador, g/s 2558. Scale = 1 mm.

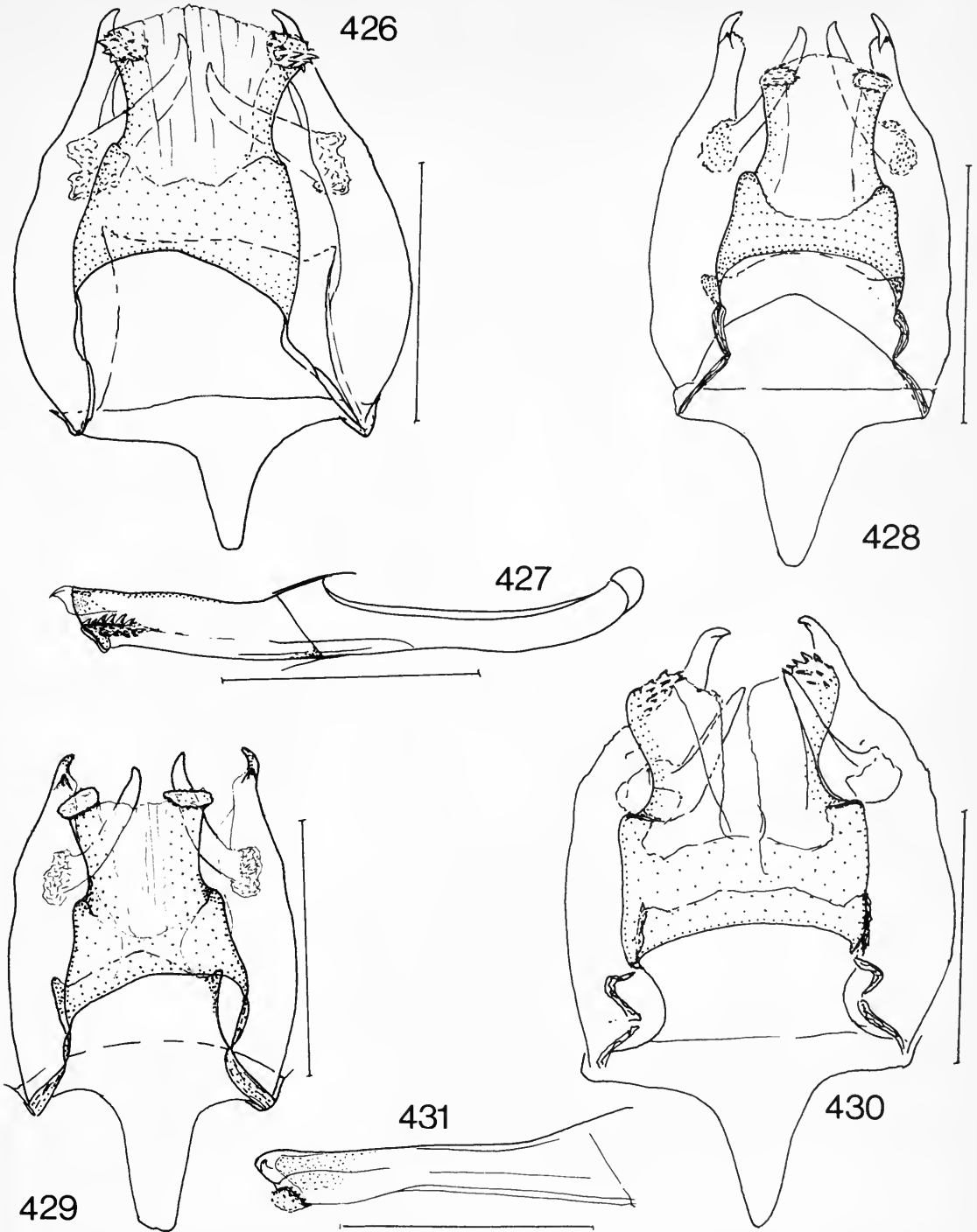

**Figs 426–431** *Eresia* species. (426) *E. phillyra*, ♂ genitalia, dorsal view, Mexico, g/s 2569; (427) same, penis, lateral view, Mexico, g/s 1239; (428) *E. aveyrona aveyrona*, ♂ genitalia, French Guiana, g/s 635; (429) *E. perna*, ♂ genitalia, Brazil, g/s 2716; (430) *E. levina*, ♂ genitalia, Colombia, g/s 98; (431) same, penis lateral view, Colombia, g/s 98. Scale = 1 mm.

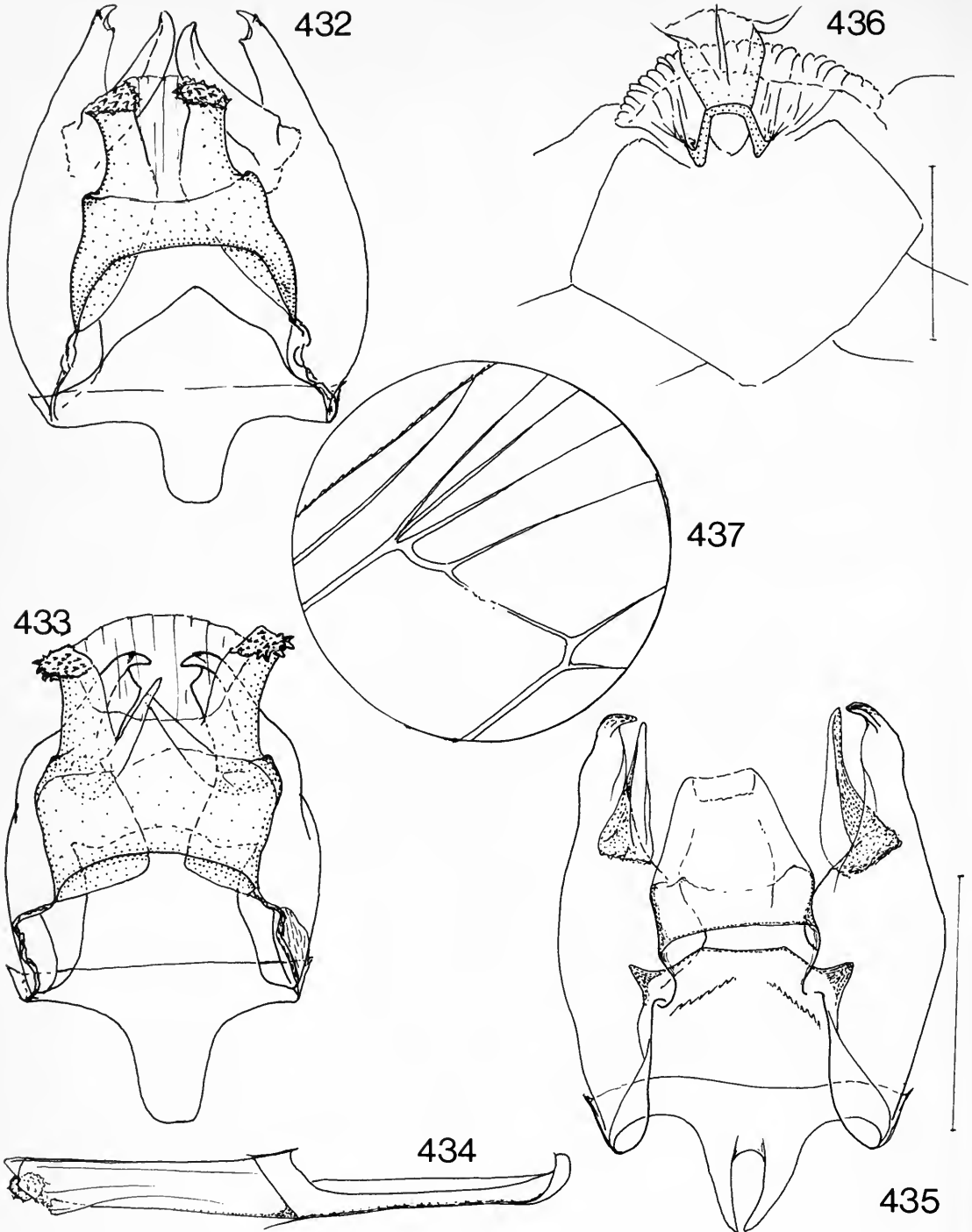

Figs 432–437 432–434, *Eresia* species. (432) *E. actinote*, ♂ genitalia, Peru, g/s 618; (433) *E. selene*, ♂ genitalia, Colombia, Manisales, g/s 832; (434) same, penis, Colombia, g/s 837. 435–437, *Castilla* species. (435) *C. castilla*, ♂ genitalia, dorsal view, Colombia, g/s 615; (436) same, ♀ genitalia, g/s 1164; (437) same, wing venation diagram. Scale = 1 mm.



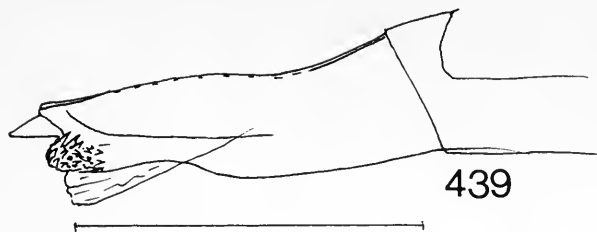

439

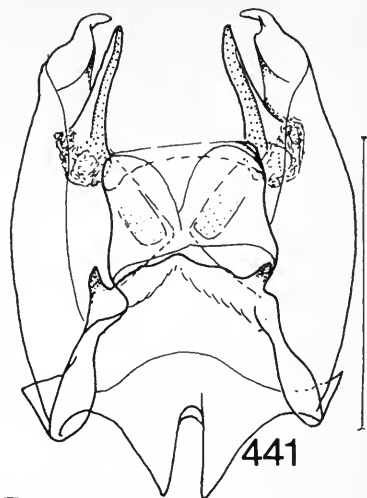

441

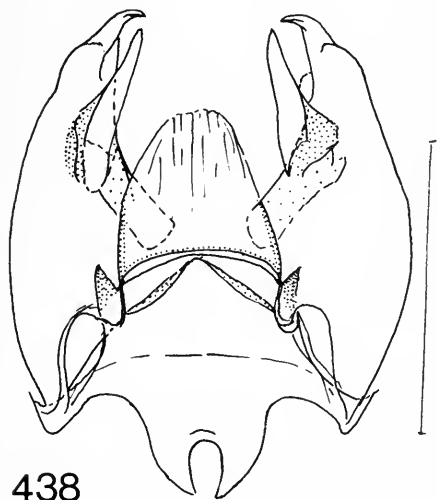

438

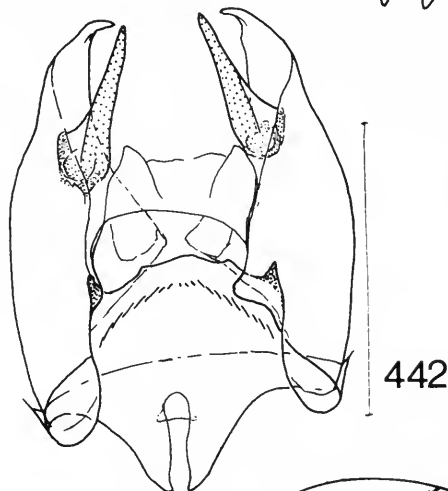

442

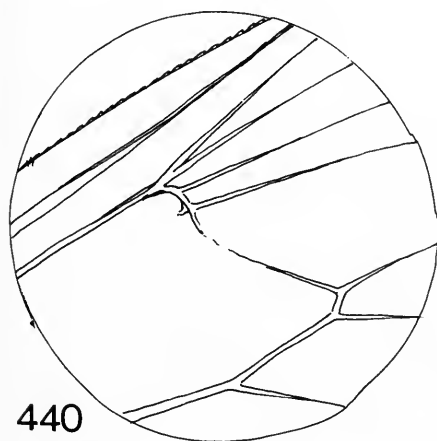

440

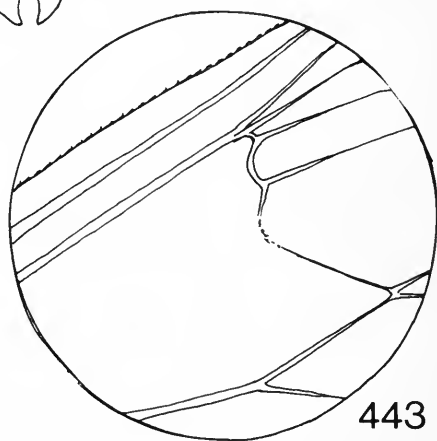

443

**Figs 438–443** *Castilia* species. (438) *C. occidentalis*, ♂ genitalia, dorsal view, Ecuador, g/s 626; (439) same, penis, lateral view, Colombia, g/s 2715; (440) same, wing venation diagram, slide 1167; (441) *C. perilla*, ♂ genitalia, dorsal view, penis removed, Ecuador, g/s 627; (442) *C. perilla* f. *acraeina*, ♂ genitalia, dorsal view, penis removed, Brazil, upper Amazons, g/s 1058; (443) *C. perilla*, wing venation diagram, discoidal area. Scale = 1 mm.

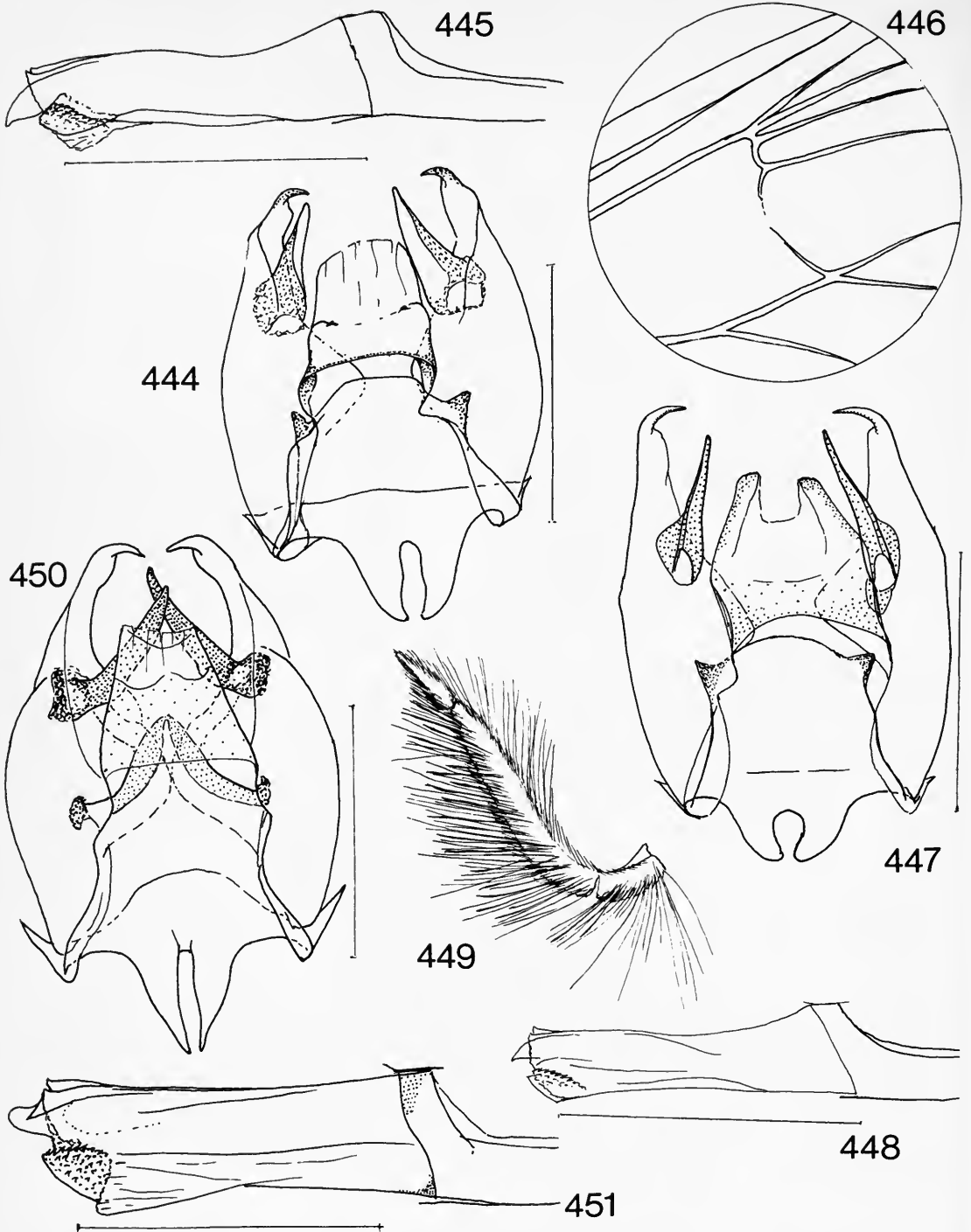

Figs 444–451 *Castilia* species. (444) *C. neria*, ♂ genitalia, dorsal view, Ecuador, g/s 619; (445) same, penis apex, lateral view, Ecuador, g/s 619; (446) same, wing venation diagram, discoidal area of forewing, slide 1169; (447) *C. northbrundii*, ♂ genitalia, dorsal view, Bolivia, g/s 611; (448) same, penis apex, lateral view, Bolivia, g/s 611; (449) same, palpus; (450) *C. eranites*, ♂ genitalia, dorsal view, Colombia, g/s 2587; (451) same, penis, lateral view, Colombia, g/s 2587. Scale = 1 mm.

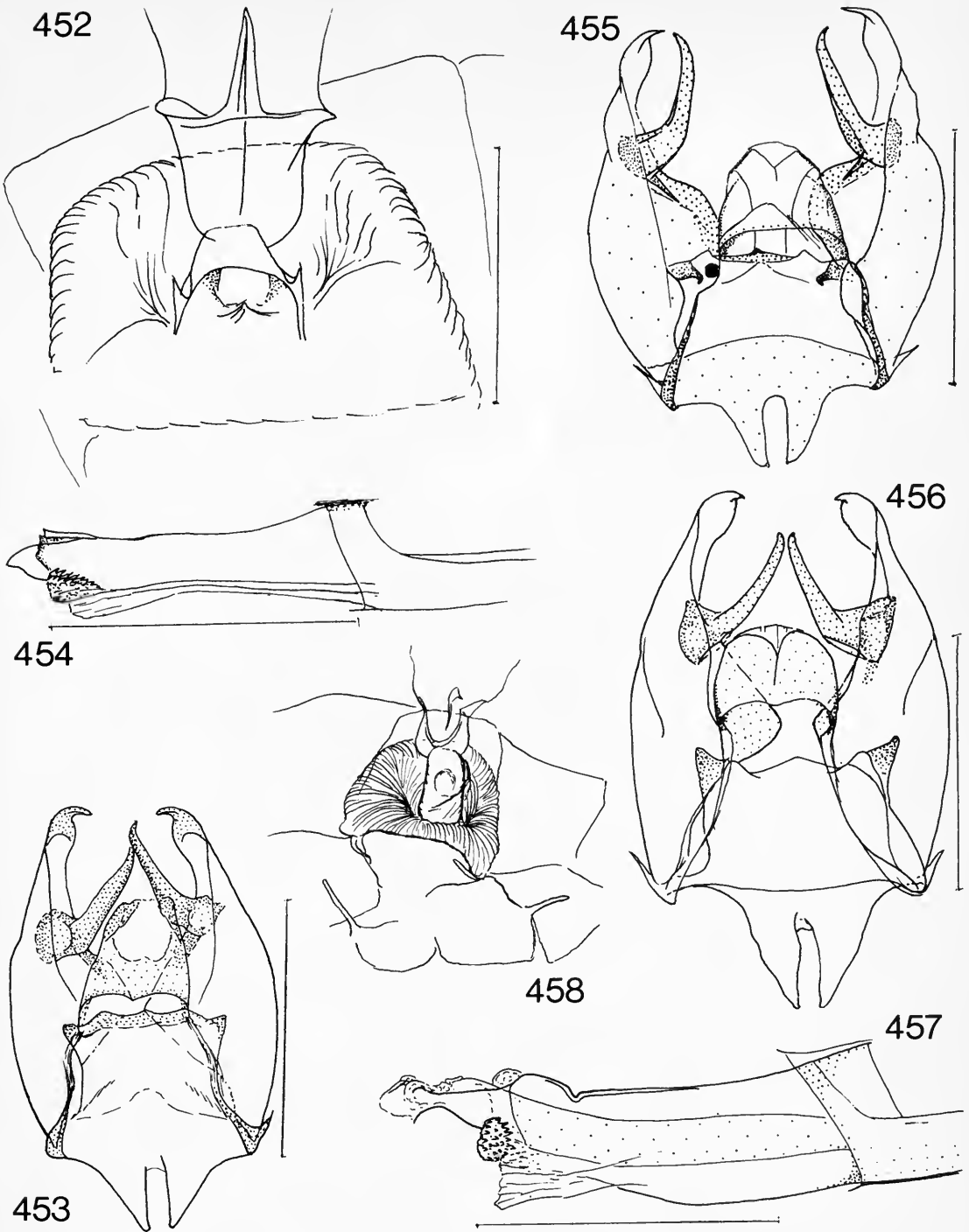

Figs 452–458 *Castilia* species. (452) *C. eranites*, ♀ genitalia, Colombia, g/s 1065; (453) *C. fulgora*, ♂ genitalia, dorsal view, Costa Rica, g/s 1021; (454) same, penis apex, lateral view, Costa Rica, g/s 1021; (455) *C. fausta*, ♂ genitalia, dorsal view, Panama, g/s 1345; (456) *C. ofella*, ♂ genitalia, Colombia, g/s 2585; (457) same, penis, lateral view, Colombia, g/s 2585; (458) same, ♀ genitalia, g/s 1063. Scale = 1 mm.

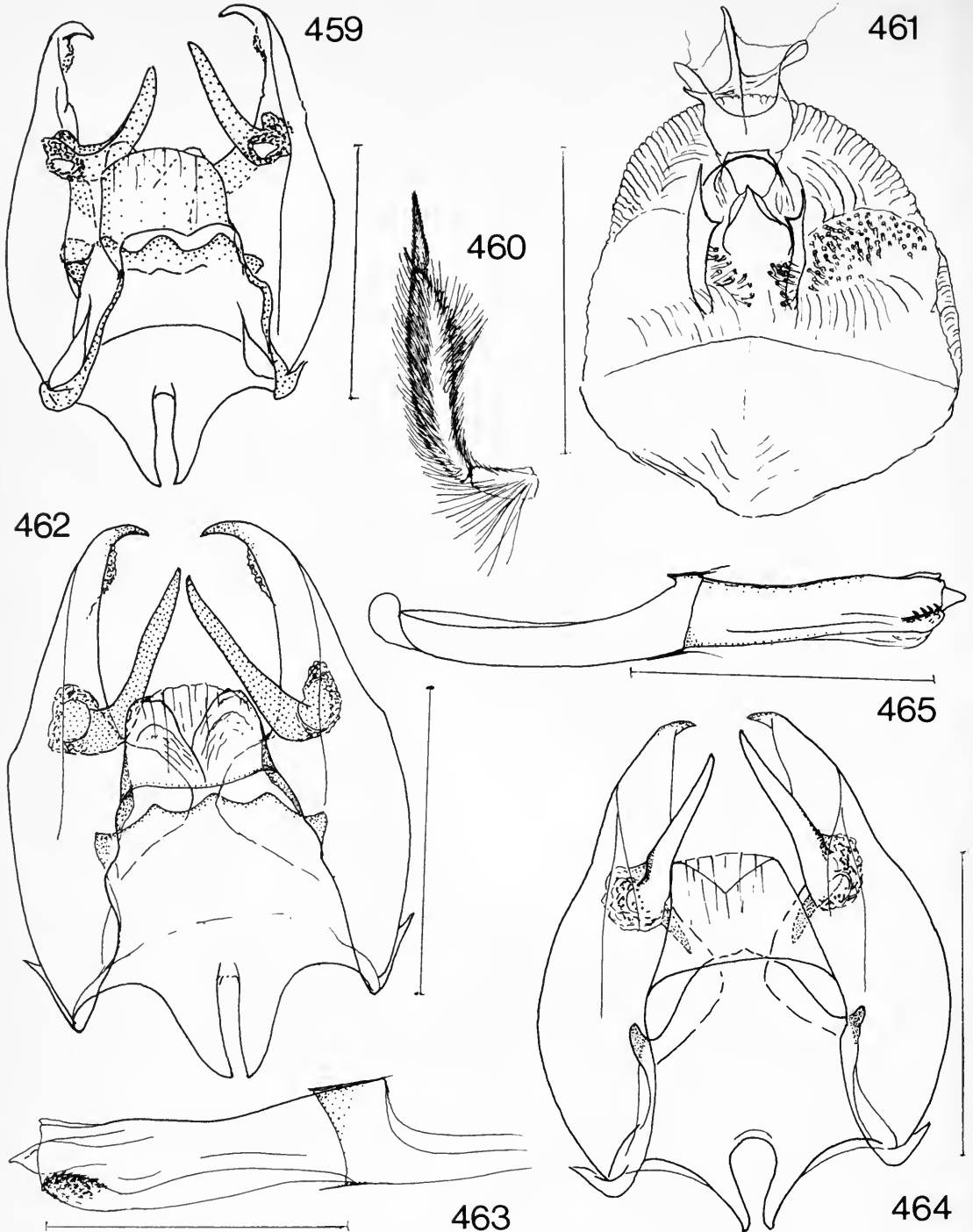

**Figs 459–465** *Castilia* species. (459) *C. myia*, ♂ genitalia, dorsal view, Mexico, Teapa, g/s 2586; (460) same, palpus; (461) same, ♀ genitalia, Guatemala, g/s 1064; (462) *C. griseobasalis*, ♂ genitalia, dorsal view, Guatemala, Volcan Santa Maria, g/s 1038; (463) same, penis, lateral view, Guatemala, Volcan Santa Maria, g/s 1038; (464) *C. angusta*, ♂ genitalia, dorsal view, Peru, Chanchamayo, g/s 835; (465) same, penis, lateral view, Bolivia, g/s 2762. Scale = 1 mm.

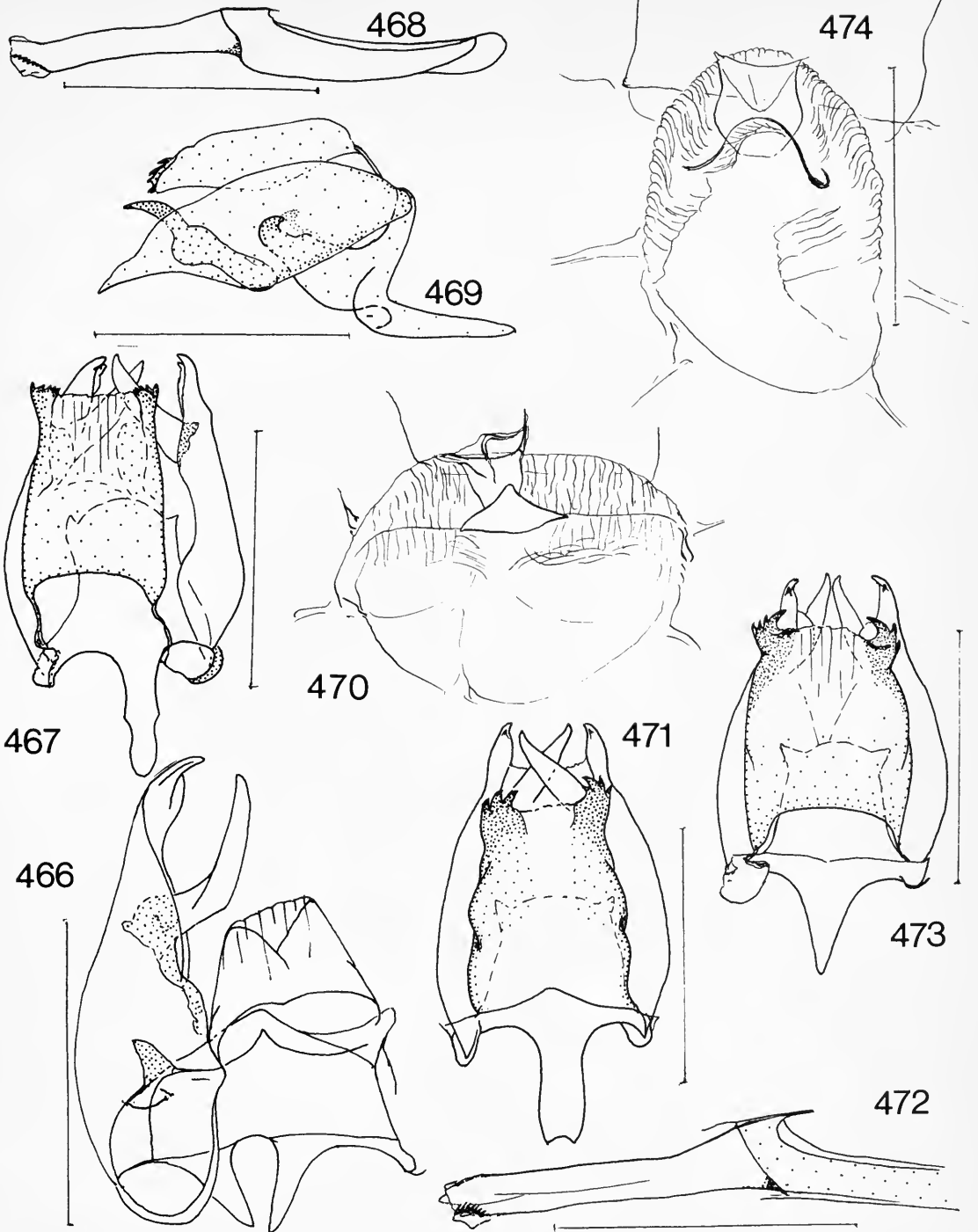

Figs 466–474 466, *Castilia angusta*, ♂ genitalia, oblique view, Bolivia, g/s 2762. 467–474, *Janatella* species. (467) *J. leucodesma*, ♂ genitalia, dorsal view, Trinidad, g/s 1349; (468) same, penis, lateral view, Trinidad, g/s 1349; (469) same, ♂ genitalia, lateral view, Venezuela, Cauca River, g/s 1348; (470) same, ♀ genitalia, Panama, g/s 1090; (471) *J. hera*, ♂ genitalia, dorsal view, Surinam, g/s 830; (472) same, distal section of penis, lateral view, Surinam, g/s 830; (473) *J. fellula*, ♂ genitalia, dorsal view, Colombia, g/s 101; (474) same, ♀ genitalia, Colombia, g/s 1088. Scale = 1 mm.

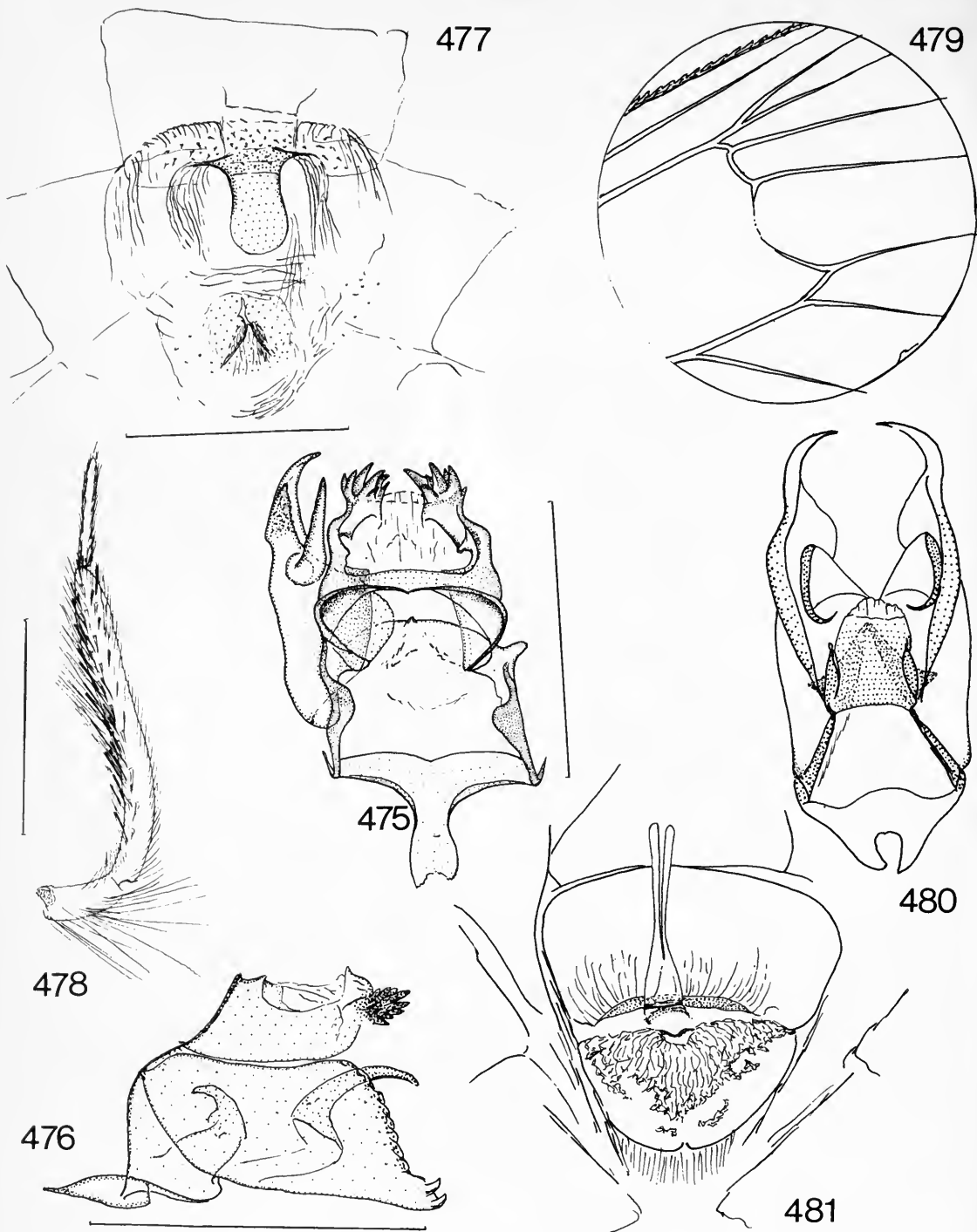

**Figs 475-481** 475-479, *Mazia* species. (475) *M. amazonica*, ♂ genitalia, dorsal view, 'Amazons', g/s 1365; (476) same, ♂ genitalia, lateral view, no locality, g/s 459; (477) same, ♀ genitalia, 'Amazon', g/s 1076; (478) same, palpus; (479) same, ♂ forewing venation diagram, discoidal area. 480, 481, *Gnathotriche* species. (480) *G. exclamationis*, ♂ genitalia, dorsal view, Colombia, g/s 82; (481) same, ♀ genitalia, dorsal view, 'Bogota', g/s 2611. Scale = 1 mm.

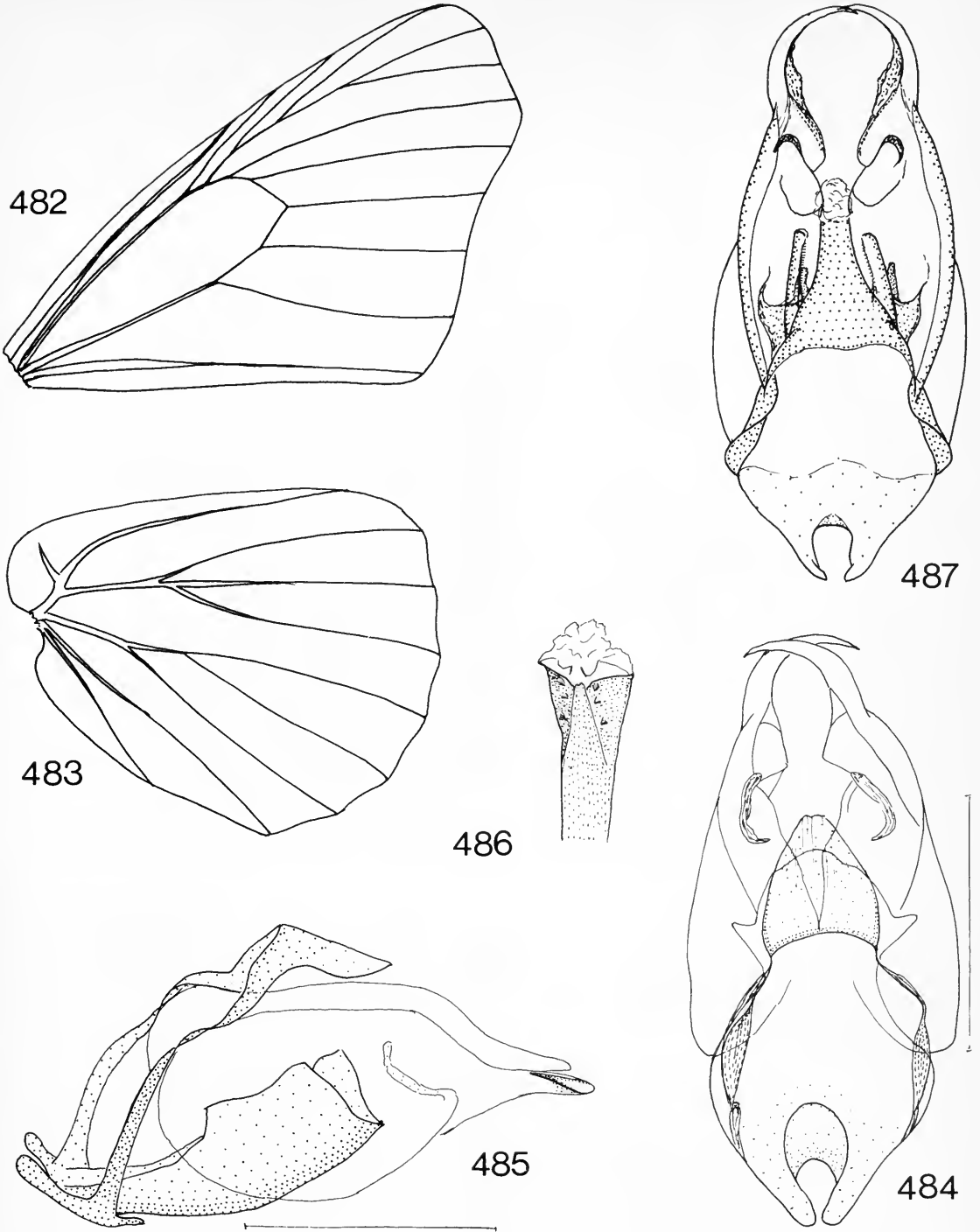

**Figs 482–487** 482–486, *Gnathotriche* species. (482) *G. exclamatoris*, forewing venation; (483) same, hindwing venation; (484) *G. sodalis*, ♂ genitalia, dorsal view, Colombia, g/s 2614; (485) same, ♂ genitalia, lateral view, Colombia, g/s 2814; (486) same, penis apex, dorsal view, Colombia, g/s 2814. 487, *Gnathotrusia mundina*, ♂ genitalia, dorsal view, Colombia, g/s 547. Scale = 1 mm.

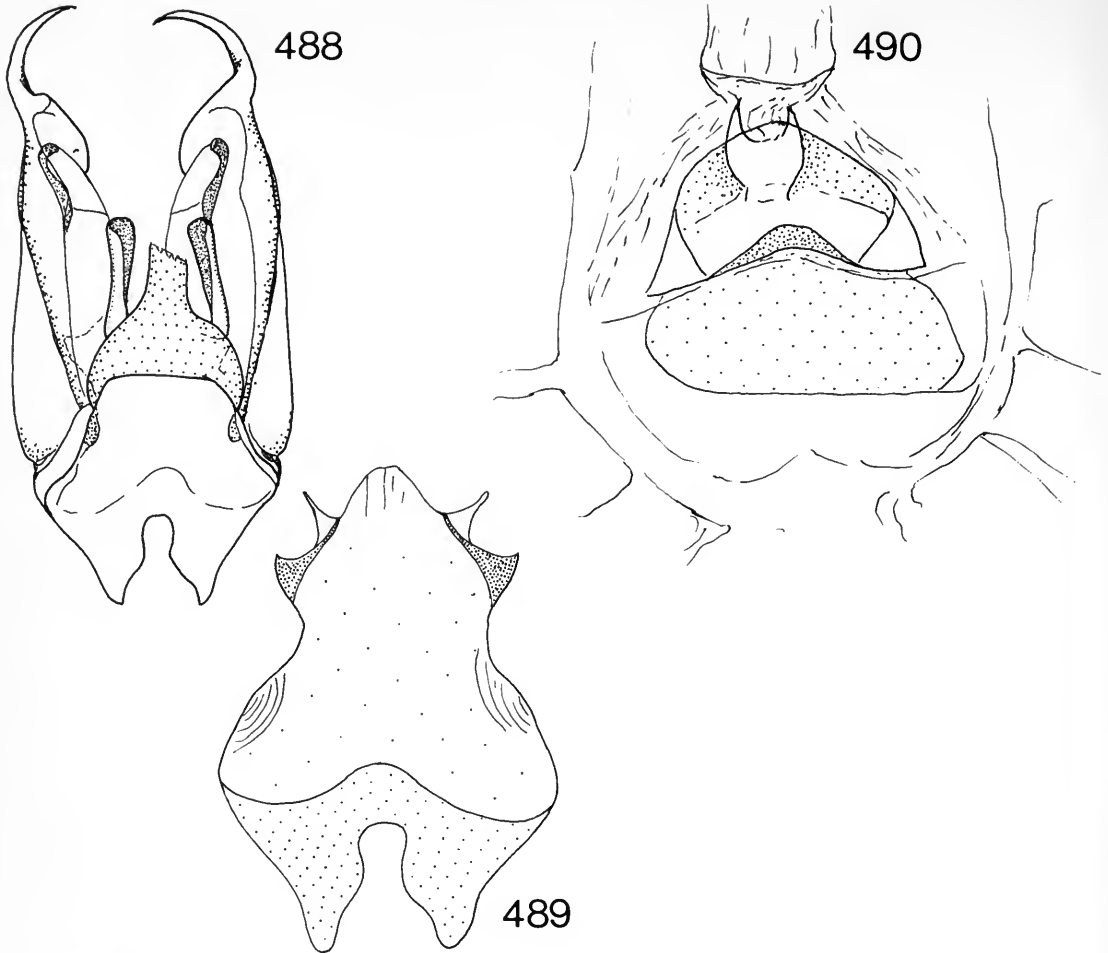

**Figs 488–490** 488, 489, *Gnathotrusia* species. (488) *G. epione*, ♂ genitalia, dorsal view, Colombia, g/s 548; (489) same, saccus and juxta, dorsal view, showing conical posterior border and densely chitinized lingulae, Colombia, g/s 548. 490, *Ortilia ihra*, ♀ genitalia, g/s 1060.

## Index

Principal references are in **bold**; invalid names are in *italics*.

abas 84, 110, **112**, 169  
*abasina* 109  
 aberrans 153  
*abrupta* 114  
 abyssinica 166  
 acastus 167  
 acesas 95, **101**, 169  
 aceta 115  
*acraea* 150  
*acraeina* Hewitson 153  
*acraeina* Staudinger 166  
 actinote 83, 130, **150**, 170  
*actinotina* 154  
*adoxa* 108

*aequatorialis* 104  
 aetherie 166  
 afghana 166  
 agar 165  
 ala 166  
 alatauica 165  
*albescens* 124  
 alceta **96**, 168  
*alethes* 96  
 alexandrina 165  
 alexon 95, **100**, 168  
*alma* 150  
 alsina 130, **137**, 138, 170  
 amator **97**, 168



- amazonica* 159, 170  
*ambigua* 165  
*ambrisia* 166  
*amoenides* 153  
*amoenua* 166  
*angusta* 152, **157**, 170  
*ancia* 165  
*anietta* 122, **126**, 169  
*annita* 101  
*annulata* **103**, 168  
*anomala* **141**, 170  
*anomalus* 167  
*Anthanassa* 84, **94**, 168  
*Antillea* 167  
*apicalis* 147  
*aquila* 127  
*arachne* 166  
*arcesia* 166  
*archisilea* 105  
*arctica* 86  
*arduina* 165  
*ardys* 95, **98**, 168  
*argentea* 95, **102**, 169  
*aricilla* 153  
*arida* 92  
*arizonensis* 89  
*asteria* 165  
*asteroidea* 165  
*athene* 166  
*athalia* 165  
*Atlantea* 170  
*atra* 120  
*atronia* 58, **102**, 168  
*aurelia* 165  
*aurinia* 165  
*aurora* 153  
*aveyrona* 130, **149**, 170  
*avinovi* 165  
  
*balba* 165  
*balbita* 166  
*barnesi* 89  
*batesii* 65, **86**, 167  
*bella* 149  
*bellona* 166  
*berenice* 110, **111**, 169  
*birivula* 109  
*boucardi* 92  
*brancodia* 104  
*britomartis* 165  
*brunhilda* 145  
*burchelli* **111**, 168  
  
*calena* 108  
*californica* 167  
*callianira* 162  
*callianthina* 163  
*callonia* 147  
*callonioides* 147  
*camillus* **87**, 168  
*campestris* 85, **87**, 167  
  
*canace* 91  
*carigia* 99  
*carme* 130, **135**, 136, 169  
*carrera* 97  
*casiphia* 130, **147**, 170  
*cassiopea* 102  
*casta* 166  
*castianira* 101  
*Castilia* 170  
*castilla* **152**, 170  
*catagraphus* 109  
*catenaria* 110, **114**, 169  
*catula* 108, **109**, 168  
*celadussa* 165  
*celemina* 142  
*centralasiae* 165  
*cerquita* 142  
*chalcedona* 165  
*chinantlensis* **157**, 170  
*chinchipensis*, 160, **168**  
*chitralensis* 166  
*Chlosyne* 166  
*chromis* 102  
*Cinclidia* 166  
*cincta* 94, 100  
*cinxia* 165  
*cissia* 130, **137**, 170  
*clara* 129, **131**, 169  
*clarior* **121**, 169  
*claudina* 84, 121, **122**, 169  
*clio* 81, 131  
*cluvia* 122, **126**, 169  
*cocyta* 85, 167  
*coela* **135**, 140, 169  
*collina* 166  
*collina-group* 166  
*collinsi* 89  
*colon* 165  
*conferta* 104  
*confirmans* 139  
*conflua* 97  
*consulis* 166  
*coracora* 167  
*cornelia* 144  
*cortes* 95, **107**, 168  
*corybassa* **144**, 170  
*crina* 162  
*crithona* 95, **104**, 168  
*cynisca* 167  
*cyno* 103  
*cynthia* 165  
*crucifera* 153  
  
*Dagon* 84, **108**, 168  
*daguana* 147  
*damaetas* 167  
*datis* 130, **143**, 170  
*decorata* 150  
*definita* 167  
*deione* 165

*delphia* 110, **115**, 169  
*derivata* 143  
*deserticola* 166  
*desfontainii* 165  
*diallus* 102  
*diamina* 165  
*dicoma* 116, **119**, 169  
*dictynna* 118  
*dicoma* 116, **119**, 169  
*didyma* 166  
*didyma-group* 166  
*Didymaeformia* 165  
*didymina* 166  
*didymoides* 166  
*dismorphina* 142  
*dora* 103  
*douglasi* 111  
*dracaena* 95, **99**, 168  
*draudti* 167  
*drymaea* 95, **107**, 168  
*drypetis* 145  
*drusilla* 94, 95, **96**, 168  
*drusinilla* 111, 128  
*dubia* 95, **106**, 168  
*durnfordi* 116, **118**, 169  
*dymas* 167  
*Dymasias* 167  
  
*editha* 165  
*edwardsi* 90  
*ehrenbergi* 167  
*elada* 167  
*elaea* 161  
*elaphiaea* 112  
*elaphina* 110, **113**, 169  
*eleates* 161  
*elenae* 163  
*elva* 167  
*emerantia* **142**, 170  
*emissa* 87  
*encina* 136  
*epione* **163**, 167  
*epula* 88  
*eranites* 152, **155**, 170  
*erebia* 162  
*Eresia* 83, 84, **129**, 161, 169  
*erodyle* 167  
*erysice* 130, **146**, 170  
*esora* 130, **145**, 170  
*estebana* 131  
*etesiae* **146**, 170  
*etia* 122, **127**, 151, 169  
*euclea* 85  
*Eueides* 83  
*eucrasia* 160  
*eunice* 130, **144**, 145, 170  
*Euphydryas* 165  
*Euphydryini* 165  
*Eurodryas* 165  
*eutropia* 130, **137**, 138, 170

*evanescens* 117  
*evanides* 155  
*exclamationis* **161**, 167  
*extensa* 129, **132**, 169  
*extincta* 109  
*ezorias* 148  
  
*fallax* 162  
*fasciatus* 167  
*fassli* 142, 143  
*fausta* 152, **155**, 170  
*felderi* 150  
*fellula* 84, **159**, 170  
*ferghana* 166  
*ferghana-group* 166  
*flavia* 122  
*flavida* 122, **124**, 169  
*flavocincta* 110, **114**, 169  
*fenestrata* 143  
*fontus* 108, **109**, 168  
*fragilis* 122, **124**, 169  
*frisica* 83, 95, **105**, 168  
*fulgora* 152, **155**, 170  
*fulviplaga* 95, **104**, 168  
*fulvocincta* 109  
  
*gabbii* 167  
*gaudealis* 167  
*gaujoni* 110, **114**, 169  
*geminia* 113  
*gentina* **116**, 169  
*gillettii* 165  
*gina* 166  
*gloriosa* 167  
*Gnathotriche* **160**, 167  
*Gnathotriche-group* 167  
*Gnathotrusia* **162**, 167  
*gorgone* 166  
*graphica* **92**, 168  
*griseobasalis* **156**, 170  
*guatemalena* 122, 124, **125**, 170  
*guaya* 156  
*gudruna* 145  
  
*harperi* 87  
*harrisii* 167  
*heliconiformis* 142  
*heliconina* 148  
*heliconoides* 153  
*hera* 84, **158**, 170  
*herlani* **90**, 168  
*hermas* 95, **104**, 168  
*hewitsonii* 148  
*Higginsius* **163**, 167  
*hilarina* 153  
*hippodrome* 167  
*hoffmanni* 167  
*homogena* 145  
*hopfferi* 162  
*Hypodryas* 165

- ianthe* 158  
*iduna* 165  
*ildica* **142**, 143  
*immaculata* 123  
*infernalis* 166  
*infrequens* 122, **124**, 169  
*intermedia* Ménétriés 165  
*intermedia* Röber 137  
*ithomioides* 130, 137, 139, **140**, 141, 170  
*ithomiola* 131  
*ithra* 116, **120**, 169
- jacinthica* 134  
*jana* 110, **111**, 169  
*janais* 167  
*Janatella* **157**, 170  
*jemezensis* 91  
*jezabel* 166
- klagesii* 145  
*kuchi* 166
- lacinia* 167  
*laias* **136**, 170  
*lansdorfi* 130, **134**, 169  
*leanira* 167  
*lelex* **96**, 168  
*letitia* 129, **133**, 169  
*leucodesma* **158**, 170  
*leucophaea* 133  
*levana* 155  
*levina* 131, **150**, 170  
*limbata* 150  
*lirioppe* **116**, 169  
*lugubris* 153  
*luka* 122, **126**, 169  
*lukto* 166  
*lunulata* 166  
*lutescens* 122, **128**  
*lycus* 136
- macarandica* 166  
*macdunnoughi* 87  
*macyi* 89  
*magniplaga* 143  
*malcolmi* 167  
*manto* 144  
*marcia* 86  
*margaretha* 130, **144**, 170  
*marianna* 167  
*marina* 167  
*mata* 89  
*maturna* 165  
*maya* 91  
*Mazia* 84, **159**, 170  
*mechanitis* 130, **147**, 170  
*mejicana* 155  
*melaina* **139**, 170  
*melini* 160  
*Melitaea* 165
- Melitaeini* 165  
*melitaeoides* 167  
*Mellicta* 165  
*Mellicta-group* 165  
*menetriesi* 165  
*metharmeoides* 160  
*mexicanus* **89**, 168  
*microdryope* 153  
*Microtia* 167  
*mima* 163  
*mimas* **138**, 170  
*mimetica* 166  
*mimicry* 144  
*minerva* 165  
*minima* 109  
*minuta* 166  
*mirabilis* 160  
*miriam* 167  
*mixta* 166  
*moesta* 130, **143**, 170  
*montanus* 85, **88**, 168  
*morenus* 108, **109**, 168  
*morpheus* 85  
*mundina* **162**, 167  
*murena* 147, 148  
*myia* 152, **156**, 170  
*mylitta* **149**, 170  
*mylittus* **88**, 168
- nana* 110, **113**, 169  
*narva* 167  
*natalces* 100  
*nauplius* 129, 131, **132**, 169  
*nazaria* 122, **127**, 169  
*nebrites* 154  
*nebulosa* 95, **101**, 168  
*neptoides* 133  
*neria* 152, **154**, 170  
*neumeogeni* 167  
*nigra* Giacomelli 120  
*nigra* Rosenberg & Talbot 133  
*nigrella* 122, **128**, 169  
*nigrina* 94  
*nigripennis* 130, **141**, 170  
*niveonotis* 128  
*nivifera* 139  
*nortbrundii* 152, **154**, 170  
*notus* 110, **113**, 169  
*nussia* 110, **113**, 169  
*nycteis* 166
- oblita* 130, **135**, 169  
*obscurata* 102  
*occidentalis* 152, **153**, 170  
*Occidryas* 165  
*ocellata* **133**, 169  
*ofella* 152, **156**, 170  
*olivencia* 131, **145**, 170  
*omosis* 113  
*orientalis* 165

- orobia 122, **123**, 169  
 orthia 116, **117**, 169  
 orticas 116, **117**, 169  
 Ortilia **115**, 169  
 orsa 88  
 orseis **90**, 168  
 otanes 95, **103**, 168
- packardii* 86  
 palla 167  
 pallas 165  
 pallescens **91**, 168  
 pallidus **89**, 168  
*pardalina* 147  
 parthenoides 165  
*pascoensis* 86  
*pastazana* 148  
*pastazena* **125**, 169  
*pedrona* 93  
*pella* 145  
*pellenea* 153  
 pelonia 130, **147**, 148, 170  
 pelops 167  
*peraea* 162  
 perezi 170  
 perilla 152, **153**, 170  
 perna 130, 149, **150**, 170  
 persea 166  
*peruana* 111  
 phaedima **143**, 170  
 phaeton 83, 165  
 phaon 83, 85, **91**, 168  
 phillyra 130, 142, **148**, 170  
 phlegias 95, **99**, 168  
 phoebe 166  
 Phyciodes 79, 84, **85**, 167  
 Phyciodini 81  
 Phystis 84, **93**, 168  
 pictus 85, **90**, 168  
 plagiata 129, **133**, 169  
*platytenia* 99  
 plotina 165  
 poecile 167  
 poecilina 130, **139**, 170  
 pola 166  
 Poladryas 166  
 polina 130, **136**, 170  
 polinella 116, **119**, 169  
*poltis* 117  
*polymnia* 145  
*pratensis* 87  
*pratti* 94  
*prisca* 143  
 proclea 167  
 pseudocolemina **141**, 170  
 ptolyca 95, 96, **97**, 168  
*pulchella* 86  
*pullopecta* 113  
*punctata* 105
- pusillus **108**, 168
- quintilla 130, **138**, 170
- reaghi* 86  
 rebeli 165  
*reducta* 131  
 regama 165  
 riina 160  
 riobalensis 167  
*roeberi* 117  
*rohweri* 87  
 romanovi 166  
 rosina 162  
 rosita 167  
*rufocincta* 120
- saladillensis **120**, 121, 169  
*saltator* 107  
 sarvistana 166  
*satura* 134  
*saturata* 134  
 saundersi 167  
 saxatilis 166  
*schaeferi* 120  
 scotosia 166  
 sejona 116, **118**, 169  
 selene 131, **151**, 170  
*selenis* 86  
*selenoides* 128  
 seminole **100**, 168  
 sepulta 110, **115**, 169  
 serpia **127**, 169  
 sestia 130, **134**, 169  
 shandura 166  
 sibina 166  
 signata 110, **112**, 169  
 similis 122, **123**, 169  
 simois **93**, 168  
 sindura 166  
 sitalces 95, **107**, 168  
 sodalis **161**, 167  
 sopolis 93, **103**, 168  
 sosis 95, **106**, 168  
*stenotaenia* 104  
*stesilea* 96  
 sticta 130, **140**, 170  
 styx Staudinger 163  
 subfasciata 138  
 subconcolor **101**, 168  
 subota **98**, 168  
*sulphurata* 134  
 sutschana 166  
 sydra 102
- taeniata 95, **106**, 168  
 tangigharuensis 166  
*taphius* 114  
 Tegosa 83, 84, **121**, 169  
 Telenassa 82, 84, **110**, 168

teletusa 110, **111**, 168  
texana 94, 95, **100**, 168  
Texola 167  
tharos **85**, 167  
*tharossa* 86  
thebais **89**, 168  
theona 167  
Thessalia 167  
*thymetus* 123  
Tisona 84, **120**, 169  
*tissa* **127**, 128  
tissoides **125**, 169  
transcaucasica 166  
trimaculata 110, **114**, 169  
*tristis* 87  
trivia 166  
tulcis 95, **105**, 168  
turkmanica 166

ursula 122, **124**, 169  
  
*vanessoides* 161  
varia 165  
variegata 93, **94**, 168  
velica 116, **118**, 169  
verena **97**, 168  
vesta 85, **92**, 168  
*vestalis* 92  
*veternosa* 134  
*virilis* 152  
  
*weneri* 150  
  
yuenty 166  
  
zamora 116, **119**, 169



# British Museum (Natural History)

1881-1981

## Centenary Publications

### **The Natural History Museum at South Kensington**

*By W. T. Stearn*

This Book presents a full history of the Museum, its collections, Directors and eminent members of staff. It provides for the first time an account of the major research undertaken and insights into the personalities of the key people in the Museum's development and evolution.

Co-published with William Heinemann.

### **Alfred Waterhouse and the Natural History Museum**

*By Mark Girouard*

Designed by Alfred Waterhouse in the 1870's the Museum is surely one of London's most outstanding pieces of architecture.

This attractively illustrated book describes the development of the design and highlights some of the building's most interesting features.

### **British Museum Natural History**

*By Peter Whitehead & Colin Keates*

The Museum is really a huge scientific research institution – acquiring, describing and classifying all manner of natural history material, both specimens and artworks. It has some of the richest collections of their kind in the world and it is these and how they are obtained and managed that are the subject of this book. The lavish, full colour illustrations and lively text will appeal to everybody interested in natural history.

Co-published with Philip Wilson Ltd.

### **Chance, Change and Challenge**

This multi-author twin volume work is one of the Museum's most ambitious publishing projects. In the first volume *The Evolving Earth* twenty scientists have been asked to summarise the present state of knowledge in their particular field, ranging from the origin of the Earth, through ocean sediments and soils to continental drift and palaeogeography.

In the companion volume *The Evolving Biosphere* Museum scientists have chosen an evolutionary concept – speciation, coevolution, biogeography etc and related this to the group of animals or plants in which they are specialising.

Co-published with Cambridge University Press.

### **Animal Identification—A Reference Guide**

VOLUME 1: MARINE AND BRACKISH WATER. *Edited by R. W. Sims.*

VOLUME 2: TERRESTRIAL AND FRESHWATER. *Edited by R. W. Sims.*

VOLUME 3: INSECTS. *Edited by D. Hollis.*

These guides provide the reader with lists of primary sources of reference that can be used to identify (or lead to the identification of) living animals throughout the world. The references are arranged in systematic and geographical sequence in order to facilitate searching.

Co-published with John Wiley & Sons Limited.

### **Nature Stored Nature Studied**

A short guide complementing the exhibition of that name to be staged in the Museum throughout 1981. It gives a fascinating insight into the history of the Museum collections and the research carried out "behind the scenes".

## **Titles to be published in Volume 43**

**A revision of the genus *Usambilla* Sjöstedt (Orthoptera: Acridoidea) and its allies.**  
By N. D. Jago.

**The Asian, Australasian and Pacific Paraboloponinae (Homoptera: Cicadellidae).  
A taxonomic revision with a key to all the known genera of the subfamily.**  
By M. D. Webb.

**A revision of *Phyciodes* Hübner and related genera, with a review of the classification  
of the Melitacinae (Lepidoptera: Nymphalidae).** By L. G. Higgins.

**A revision of six minor genera of Myrmicinae (Hymenoptera: Formicidae) in the  
Ethiopian zoogeographical region.** By Barry Bolton.





# Bulletin of the British Museum (Natural History)

A revision of six minor genera of  
Myrmicinae (Hymenoptera: Formicidae)  
in the Ethiopian zoogeographical region

Barry Bolton

Entomology series  
Vol 43 No 4

26 November 1981

The *Bulletin of the British Museum (Natural History)*, instituted in 1949, is issued in four scientific series, Botany, Entomology, Geology (incorporating Mineralogy) and Zoology, and an Historical series.

Papers in the *Bulletin* are primarily the results of research carried out on the unique and ever-growing collections of the Museum, both by the scientific staff of the Museum and by specialists from elsewhere who make use of the Museum's resources. Many of the papers are works of reference that will remain indispensable for years to come.

Parts are published at irregular intervals as they become ready, each is complete in itself, available separately, and individually priced. Volumes contain about 300 pages and several volumes may appear within a calendar year. Subscriptions may be placed for one or more of the series on either an Annual or Per Volume basis. Prices vary according to the contents of the individual parts. Orders and enquiries should be sent to:

Publications Sales,  
British Museum (Natural History),  
Cromwell Road,  
London SW7 5BD,  
England.

*World List* abbreviation: *Bull. Br. Mus. nat. Hist.* (Ent.)

© Trustees of the British Museum (Natural History), 1981

**This number completes Volume 43**

ISSN 0524-6431

British Museum (Natural History)  
Cromwell Road  
London SW7 5BD

Entomology series  
Vol 43 No 4 pp 245-307

Issued 26 November 1981



# A revision of six minor genera of Myrmicinae (Hymenoptera: Formicidae) in the Ethiopian zoogeographical region

Barry Bolton

Department of Entomology, British Museum (Natural History), Cromwell Road, London SW7 5BD

## Contents

Synopsis . . . . .	246
Introduction . . . . .	246
Measurements and indices . . . . .	246
Abbreviations of museums . . . . .	247
<i>Ankylomyrma</i> Bolton . . . . .	247
<i>Atopomyrmex</i> André . . . . .	249
Synonymic list of species . . . . .	250
Key to species (workers) . . . . .	250
Treatment by species . . . . .	250
<i>Baracidris</i> <b>gen. n.</b> . . . . .	252
Key to genera of Ethiopian region Myrmicinae with 2-segmented antennal club (workers) . . . . .	253
List of species . . . . .	255
Key to species (workers) . . . . .	255
Treatment by species . . . . .	255
<i>Cyphoidris</i> Weber . . . . .	256
List of species . . . . .	257
Key to species (workers) . . . . .	257
Treatment by species . . . . .	257
<i>Ocymyrmex</i> Emery . . . . .	260
Synonymic list of species . . . . .	262
Key to species (workers) . . . . .	262
Treatment by species . . . . .	264
<i>Pristomyrmex</i> Mayr . . . . .	282
Synonymic list of species . . . . .	283
Key to species (workers) . . . . .	283
Treatment by species . . . . .	284
<i>Terataner</i> Emery . . . . .	288
List of species . . . . .	290
Key to species (workers) . . . . .	290
Treatment by species . . . . .	291
Synopsis of Malagasy region species . . . . .	296
Key to species (workers) . . . . .	297
Acknowledgements . . . . .	298
References . . . . .	298
Index . . . . .	307

## Synopsis

The ant genera *Ankylomyrma* Bolton, *Atopomyrmex* André, *Cyphoidris* Weber, *Ocymyrmex* Emery, *Pristomyrmex* Mayr (= *Odontomyrmex* André, = *Hylidris* Weber, = *Dodous* Donisthorpe) and *Terataner* Emery (= *Tranetera* Arnold) are revised for the Ethiopian zoogeographical region. Keys and descriptions of species are presented for each genus and the genera are defined on a world-wide basis. In *Atopomyrmex* two species are recognized and four new infraspecific synonyms are established. Three new species are described in the previously monotypic genus *Cyphoidris*. Twenty-three species of *Ocymyrmex* are recognized of which seven are described as new; seven new synonyms are established and new status as valid species is granted to seven previously infraspecific forms. Five *Pristomyrmex* species are recognized of which one is new; five new synonyms are proposed in this genus. In *Terataner* the former subgenus *Tranetera* is newly synonymized and six species recognized, of which one is new. The six *Terataner* species of Madagascar are summarized, one new species is described and a key presented. The genus *Baracidris* is described as new, containing two new species from west and central Africa. A key to Ethiopian region myrmicine genera in which the antennal club has two segments is given under *Baracidris*.

## Introduction

This paper is presented as a contribution towards a revision of the subfamily Myrmicinae in the Ethiopian zoogeographical region. The subfamily Myrmicinae is by far the largest and most diverse in the region (and the world), containing some 43 genera in sub-Saharan Africa at present. These genera can be categorized roughly as small (1–10 species), moderate (10–40 species) and large (more than 40 species). The vast majority of Ethiopian region myrmicine genera fall into the small category (29 genera), about nine genera come in the moderate category and only five reach the final category, of which three (*Tetramorium* Mayr, *Pheidole* Westwood and *Crematogaster* Lund) are huge, with well over 100 species each in the region. A good indication of distribution of genera on a world basis is given by Brown (1973), and a discussion of the most prevalent ant genera is presented by Wilson (1976).

Of the seven genera discussed in this paper only *Ocymyrmex*, with 23 species, reaches the moderate category; the rest, *Ankylomyrma* (1 species), *Atopomyrmex* (2 species), *Baracidris* (2 species), *Cyphoidris* (4 species), *Pristomyrmex* (5 species) and *Terataner* (6 species), are all small in terms of number of species. Only two of the genera under consideration here have species which occur outside of the Ethiopian region, *Terataner* and *Pristomyrmex*; the rest are peculiar to the region. *Terataner*, apart from its six African species, has another six in the Malagasy region whilst *Pristomyrmex* species are widely distributed in the Old World tropics, reaching a peak in the Indo-Australian region.

## Measurements and indices

**Total Length (TL).** The total outstretched length of the individual, from mandibular apex to gastral apex.

**Head Length (HL).** The length of the head proper, excluding the mandibles, measured in a straight line from the anteriormost point of the median clypeal margin to the mid-point of the occipital margin, in full-face view. (In species with strongly concave occipital margin the head length is measured to the mid-point of a line connecting the posterolateral projections.)

**Head Width (HW).** The maximum width of the head in full-face view, measured behind the eyes except in *Ankylomyrma* (eyes in the posterior corners) and in *Ocymyrmex* (head often narrows rapidly behind eyes) where HW is measured immediately in front of the eyes.

**Cephalic Index (CI).**

$$\frac{HW \times 100}{HL}$$

**Scape Length (SL).** The maximum straight-line length of the antennal scape excluding the basal constriction or neck close to the condylar bulb.

**Scape Index (SI).** 
$$\frac{SL \times 100}{HW}$$

**Pronotal Width (PW).** The maximum width of the pronotum in dorsal view. In *Terataner* PW is measured behind the prominent angular or dentiform corners.

**Alitrunk Length (AL).** The diagonal length of the alitrunk in lateral view from the point at which the pronotum meets the cervical shield to the posterior base of the metapleural lobes or teeth.

All measurements are expressed in millimetres.

### Abbreviations of museums

AMNH, New York	American Museum of Natural History, New York, U.S.A.
BMNH	British Museum (Natural History), London, U.K.
CAS, San Francisco	California Academy of Sciences, San Francisco, California, U.S.A.
IE, Bologna	Istituto di Entomologia dell'Università, Bologna, Italy.
IRSNB, Brussels	Institut Royal des Sciences Naturelles de Belgique, Brussels, Belgium.
MCSN, Genoa	Museo Civico di Storia Naturale 'Giacomo Doria', Genoa, Italy.
MCZ, Cambridge	Museum of Comparative Zoology, Cambridge, Massachusetts, U.S.A.
MHN, Geneva	Muséum d'Histoire Naturelle, Geneva, Switzerland.
MNHN, Paris	Muséum National d'Histoire Naturelle, Paris, France.
MNHU, Berlin	Museum für Naturkunde der Humboldt-Universität, Berlin, Germany (D.D.R.).
MRAC, Tervuren	Musée Royal de l'Afrique Centrale, Tervuren, Belgium.
NM, Basle	Naturhistorisches Museum, Basle, Switzerland.
NM, Bulawayo	National Museum, Bulawayo, Zimbabwe.
USNM, Washington	United States National Museum, Washington, D.C., U.S.A.
ZM, Kiev	Zoological Museum, Institute of Zoology, Academy of Sciences of Ukrainian, S.S.R., Kiev, U.S.S.R.

### *ANKYLOMYRMA* Bolton

(Figs 1, 2)

*Ankylomyrma* Bolton, 1973b: 235. Type-species: *Ankylomyrma coronacantha* Bolton, loc.cit.; by original designation.

**DIAGNOSIS OF WORKER.** Monomorphic arboreal myrmicine ants. Mandibles with 5 sharply defined large triangular teeth, the mandibles almost entirely concealed by the clypeus when closed. Palp formula 5, 3, the palpomeres very long (apical maxillary palpomere equal in length to apical antennal segment). Clypeus very large, projecting forwards over the mandibles as a broad shelf. Median portion of clypeus raised, broad posteriorly and broadly inserted between the widely separated frontal lobes. Frontal lobes concealing antennal insertions, prolonged back by a pair of irregular frontal carinae which run past the inner margins of the eyes to the occipital margin. Frontal carinae forming dorsal margins of a weak scrobe which is bounded below by a ridge running from below the eye to the mandibular insertions. Eyes large, situated at

extreme posterolateral corners of head, within the scrobal area as defined by the frontal carinae and ridge. Antennae 12-segmented, without a strongly defined club, the flagellomeres increasing in size apically. Occipital margin bounded by a broad transverse lamella which projects into a series of dentiform processes; occiput behind the lamella broad and flat. Promesonotum swollen, large and convex, without sutures but with 4 pairs of roughly triangular teeth or prominences. Propodeum short and strongly bispinose. Metapleural lobes absent. Mesopleuron divided by a broad transverse suture and a broad suture separating meso- and metapleuron present. Petiole strongly bispinose, with a broad anterior peduncle which grades into the node. Gaster consisting almost entirely of the massively enlarged and strongly vaulted first tergite. The first sternite is visible as a narrow collar fringing the ventral portion of the forward-pointing orifice of the tergite; remaining gastral segments very small and telescoped inside. Sting strongly developed and projecting anteriorly below the pedicel segments.

In the original description of this remarkable ant I placed the genus tentatively in the tribe Meranoplini. I am aware now that this move was incorrect and that *Ankylomyrma* is not close to *Meranoplus* or any other member of that now-disbanded tribe (for discussion see Bolton, 1981). The real relationships of *Ankylomyrma* are an enigma for, although there are a number of characters implying alliance with genera such as *Atopomyrmex*, *Terataner* and their allies, such as low dental count, high palp formula, broad clypeus and structure of petiole, there are also objections to such a placement. Chief among these must be the position of the eyes, situated as they are at the extreme posterior corners of the sides of the head and within what is strictly the scrobal area. In *Terataner* and allies the eyes are always positioned well forward of the occipital corners and below the scrobes when such are present. The incredible occipital fringe and unique gastral development of *Ankylomyrma* are of course very derived characters which, though they serve to isolate the genus, do nothing to indicate its relationships. The only known species is as follows.

### *Ankylomyrma coronacantha* Bolton

(Figs 1, 2)

*Ankylomyrma coronacantha* Bolton, 1973b: 235, figs 1-3. Holotype worker, GHANA: Eastern Region, Mt Atewa; by pyrethrum knockdown, sample A4/3, 12.vii. 1969 (*D. Leston*) (BMNH) [examined].

WORKER. TL 6.3-6.8, HL 1.48-1.50, HW (at maximum in front of eyes) 1.38-1.42, CI 92-96, SL 1.06-1.12, SI 76-80, PW 1.20-1.22, AL 1.92-1.95 (4 measured).

Mandibles delicately and superficially longitudinally striate, with scattered fairly conspicuous pits. Palpi very long, the maxillary palps projecting beyond the posteroventral margin of the head when stretched out, their total length c. 1.60. Anterior clypeal margin with a median impression. Main features of head as given in generic diagnosis and Fig. 2. Eyes large, maximum diameter 0.36-0.38, about 0.27-0.28 × HW, situated at posterolateral corners of head. Frontal carinae irregular, running inside eyes to occipital margin. Scrobal area bounded below by a ridge which runs from the mandibular insertions to the extensive prominence at the occipital corner, below the eye. Occipital margin with a transverse raised broad lamella which projects into a number of teeth or spines, projecting especially strongly at the occipital corners. Promesonotum fused and swollen, the dorsum much higher than the propodeum in profile. Metanotal groove absent. Pronotum with three pairs of teeth or tubercles; dorsally with a pair of broad tubercles which are large and are seen to be blunt or truncated in anterior view; dorsolaterally, just anterior to pro-mesonotal junction, with a pair of broad acute, sometimes conical projections; humeral angles bluntly dentate, the teeth prominent in dorsal view. Mesonotum at point where sclerite begins to slope down to the propodeum with a pair of broad, acute teeth. Propodeal dorsum short, the entire dorsal face forming the base for a pair of long, stout spines. Apices of tibiae each terminating in a pair of cuticular tooth-like outgrowths. Petiole strongly bispinose, in profile the peduncle short and continuous with the dorsal surface of the node. Subpetiolar process a small tooth, anteriorly situated. First gastral tergite massive, developed into a subspherical ball which has an opening anteriorly, below the postpetiole. First sternite forms a narrow collar around the ventral portion of the orifice so that almost all of the visible gaster consists only of the first tergite. Sting strong and projecting anteriorly. Dorsum of head coarsely reticulate-rugose, the rugae strongly raised and enclosing broad foveolate spaces. Ground-sculpture of fine shagreening or superficial punctulation. This sculpture also present on

sides of head below the scrobes but the scrobal area itself merely densely reticulate-punctate. All pronotum and raised dorsum of mesonotum sculptured as dorsum of head but the pleurae, the sloping portion of the mesonotum and the propodeum with fine dense but superficial reticulation only. Petiole, postpetiole and first gastral tergite coarsely foveolate, the interspaces finely reticulate or reticulate-punctulate. Dorsum of head with numerous stout erect hairs which are also present, but sparser, on dorsum of promesonotum and dorsal portion of first gastral tergite; the hairs are denser and finer ventrally on the first tergite but do not occur on the sloping posterior half of the mesonotum, the propodeum or the petiole. Black with appendages lighter, orange-brown to red-brown.

This large and very spectacular ant is arboreal, but beyond that nothing is known of its biology.

#### MATERIAL EXAMINED

**Ghana:** Mt Atewa (*D. Leston*). **Cameroun:** Korup (*D. Jackson*).

### *ATOPOMYRMEX* André

(Figs 3–11)

*Atopomyrmex* André, 1889: 226. Type-species: *Atopomyrmex mocquerysi* André, op. cit.: 227; by monotypy.

**DIAGNOSIS OF WORKER.** Polymorphic arboreal myrmicine ants. Mandibles short and stout, the apical (masticatory) margin armed in smallest workers with 2 teeth followed by 2 denticles and an unarmed straight edge; in slightly larger workers the edge crenulate or feebly denticulate. Most medium-sized and large workers with 2 teeth + 4–5 denticles but in large workers all the teeth may be worn down and rounded. Palp formula 4, 3 in all sizes; in smallest workers the two basalmost maxillary palp segments may be partially fused. Median portion of clypeus shield-like, broad, posteriorly broadly inserted between the frontal lobes. Anterior clypeal margin indented to concave medially, the median portion separated from the lateral parts by a longitudinal carina on each side. Anterior tentorial pit represented by a deep and sharply incised hole which is roughly circular, situated immediately behind the clypeus close to the antennal insertions and more obvious in larger workers. Development of frontal carinae varying with worker size. In smallest workers short and only feebly divergent, ending in front of the level of the anterior margins of the eyes. In largest workers extending back beyond the level of the posterior margins of the eyes and strongly divergent from source to level of eyes; behind this roughly parallel. Workers between largest and smallest showing intermediate development of frontal carinae. Antennal scrobes absent in smallest workers, becoming longer and deeper with increasing size; conspicuous and capable of accommodating the scape in largest workers. Antennae 12-segmented with a 3-segmented club. With head in full-face view the eyes situated behind the midlength of the sides, and the occipital corners broadly and evenly rounded. Pronotum more or less flat to shallowly concave transversely, bluntly marginate laterally, the margination more acute in smaller workers. Promesonotal suture vestigial to absent from dorsum but at sides forming an impression separating pronotum and mesonotum. Mesonotum in profile usually broadly and bluntly bituberculate behind, then sloping almost vertically to the broad metanotal groove. In medium to large workers the mesonotum with a shallow but quite broad transverse impression at about the midlength. Propodeum in profile raised immediately behind the metanotal groove then sloping downwards to a pair of strong spines. Metapleural lobes inconspicuous, very narrow and low. Propodeal spiracle circular. Lower margin of metapleuron without a broad groove running forward from the orifice of the metapleural glands; instead the margin rounded and folded under, giving the appearance of being smoothly eroded away, the hind coxa appearing to rest upon the bulla of the metapleural gland. Ventral surface of alitrunk with a very conspicuous roughly circular deep pit between the hind coxae, a sieve-plate apparently present at the bottom of the pit. Petiole dorsally with a pair of short stout spines of variable size. Dorsal surfaces of head and body without standing hairs, such hairs present only on mouthparts and gastral sternites.

*Atopomyrmex* is a small genus of strongly polymorphic arboreal ants. The two species included, *mocquerysi* and *cryptocerooides*, nest in the wood of standing trees and forage arboreally, frequently coming down the trunk but only rarely venturing onto the ground. Arnold (1916) points out that *mocquerysi* is usually carnivorous and, when disturbed, exudes a whitish secretion from the anal glands. Nests are made in hollow stems or rotten parts of standing timber but it is not

known if the species tunnel their own galleries or take over the galleries of termites and boring beetles. Of the two species *mocquerysi* is very widely distributed, being found in wooded and forested areas almost throughout sub-Saharan Africa; Wheeler (1922: 181) gives a distribution map. *A. cryptoceroides* has a more limited range, being confined to the rain-forest zones of west of central Africa, where it is sympatric with *mocquerysi*.

The genus most closely related to *Atopomyrmex* is the Ethiopian and Malagasy genus *Terataner*. Differences separating them, and other related genera, are noted in the discussion of *Terataner* (p. 290). At its inception *Atopomyrmex* contained only *mocquerysi*. Soon afterwards *cryptoceroides* was added and this was followed by a number of others, added later by several authors. Later still these extra species were progressively removed from *Atopomyrmex* until the present time, when *mocquerysi* and *cryptoceroides* are again its only members. These species, originally described in *Atopomyrmex* but now placed elsewhere, are as follows. The species *alluaudi* Emery, *bottegoi* Emery, *foreli* Emery, *luteus* Emery, *scotti* Forel, and *steinheili* Forel were transferred to *Terataner* by Emery (1912); *nodifier* Emery was originally made type-species of genus *Atopula* Emery but is now included in *Tetramorium* Mayr, see Bolton (1976; 1980); *selebensis* Emery was made type-species of *Dilobocondyla* Santschi, by Santschi (1910); *escherichi* Forel was transferred to *Dilobocondyla* by Forel (1913c); *ceylonicus* Emery was made type-species of *Paratopula* Wheeler, by Wheeler (1919).

### Synonymic list of species

*cryptoceroides* Emery

*deplanatus* Mayr

*mocquerysi* var. *curvispina* Forel

*mocquerysi* subsp. *cryptoceroides* var. *melanoticus* Wheeler (unavailable)

*mocquerysi* André

*mocquerysi* var. *australis* Santschi

*mocquerysi* var. *obscura* Santschi **syn. n.**

*mocquerysi* var. *arnoldi* Santschi **syn. n.**

*mocquerysi* st. *opaca* Santschi **syn. n.**

*mocquerysi* var. *erigens* Santschi **syn. n.**

*mocquerysi* st. *opacus* var. *nigellus* Santschi (unavailable).

### Key to species (workers)

- 1 Sides of head behind eyes blanketed by a fine and very dense reticulate-puncturation. (Woodland and forest zones throughout Africa) . . . . . *mocquerysi* (p. 251)
- Sides of head behind eyes smooth and glossy between widely separated small pits. (Rainforests of West and Central Africa) . . . . . *cryptoceroides* (below)

### Treatment by species

#### *Atopomyrmex cryptoceroides* Emery

(Figs 9, 11)

*Atopomyrmex cryptoceroides* Emery, 1891: 561, pl. 15, figs 5, 6. Holotype female, IVORY COAST: Assinie (C. Alluaud) (MCSN, Genoa) [examined].

*Atopomyrmex deplanatus* Mayr, 1895: 113. Holotype worker, SIERRA LEONE: 'Riv. N' Gamie, Chûtes de Samlia (A. Mocquerys) (IRSNB, Brussels). [Synonymy by Emery, 1899: 477.]

*Atopomyrmex mocquerysi* var. *curvispina* Forel, 1911: 311. Syntype workers, ZAIRE: Kondué (E. Luja) (MHN, Geneva) [examined]. [Synonymy by Emery, 1922: 240.]

*Atopomyrmex mocquerysi* subsp. *cryptoceroides* var. *melanoticus* Wheeler, 1922: 182, fig. 44. Syntype workers, ZAIRE: between Lukolela and Basoko (H. O. Lang) (BMNH) [examined]. [Name not available.]

WORKER. Answering to the description of *mocquerysi* and falling into the size range noted there; differing from *mocquerysi* as follows.



*cryptoceroides*

Sides of head behind eyes smooth and shining between widely scattered pits, not blanketed by reticulate-punctate sculpture and never with rugulae in this area.

Propodeal dorsum strongly rugose, without or only with vestiges of punctate sculpture.

Pronotal dorsum closely and coarsely rugose, without dense punctate ground-sculpture.

Propodeal spines in dorsal view with their basal portions projecting outwards before angling backwards (Fig. 11), the projecting portion concealing the spiracle which is not at all visible from above.

Propodeal spiracle large and relatively close to the margin of the declivity below the spine; diameter of spiracle equal to or greater than the distance separating the spiracular hind margin from the edge of the declivity at its closest point (Fig. 9).

## MATERIAL EXAMINED

**Ghana:** Tafo (*G. S. Cotterell*); Tafo (*Strickland*); Mampong (*D. Leston*); Kibi (*D. Leston*); Bunso (*D. Leston*); Osenasi (*D. Leston*); Asamankese (*D. Leston*); Etukrom (*D. Leston*); Mpraeso (*D. Leston*).  
**Zaire:** Ituri For., Beni (*T. H. E. Jackson*).

*mocquersyi*

Sides of head behind eyes blanketed by dense reticulate punctate sculpture; sometimes rugulae may also occur in this area.

Propodeal dorsum predominantly or entirely reticulate-punctate, if rugulae occur they are secondary to the punctation.

Pronotal dorsum usually with rugae present but with punctate ground-sculpture which is usually conspicuous and dense.

Propodeal spines in dorsal view directed more or less evenly backwards, not projecting outwards basally; the spiracle (or at least its annulus) clearly visible from above (Fig. 10).

Propodeal spiracle smaller and some distance away from the margin of the declivity below the spine; diameter of spiracle less than the distance separating the spiracular hind margin from the edge of the declivity at its closest point (Fig. 8).

*Atopomyrmex mocquersyi* André

(Figs 3–8, 10)

*Atopomyrmex mocquersyi* André, 1889: 227. Syntype workers, SENEGAL: Dakar (*A. Mocquersyi*) (MNHN, Paris) [examined].

*Atopomyrmex mocquersyi* var. *australis* Santschi, 1914a: 16. Syntype workers, SOUTH AFRICA: Natal, Zululand (*I. Trägårdh*) (NM, Basle) [examined]. [Synonymy by Wheeler, 1922: 885.]

*Atopomyrmex mocquersyi* var. *obscura* Santschi, 1923: 283. Syntype workers, IVORY COAST: Jacqueline (*Lohier*); and BENIN: Cotonou (*Silvestri*) (MRAC, Tervuren; NM, Basle) [examined]. **Syn. n.**

*Atopomyrmex mocquersyi* var. *arnoldi* Santschi, 1923: 283. Syntype workers, ZAIRE: Eala (*R. Mayné*) (NM, Basle; MRAC, Tervuren) [examined]. **Syn. n.**

*Atopomyrmex mocquersyi* st. *opaca* Santschi, 1923: 283. Syntype workers, ANGOLA: 'Rivière Cubia, entre Combo et Cubra' (*Rohan-Chabot*) (MRAC, Tervuren; NM, Basle) [examined]. **Syn. n.**

*Atopomyrmex mocquersyi* var. *erigens* Santschi, 1924: 205. Syntype workers, ZAIRE: Yambata (*Di Giorgi*) (NM, Basle; MRAC, Tervuren) [examined]. **Syn. n.**

*Atopomyrmex mocquersyi* st. *opacus* var. *nigellus* Santschi, 1930: 72. Syntype workers, ANGOLA: Rio Mbalé and Chimporo (*A. Monard*) (NM, Basle) [examined]. [Name not available.]

**WORKER.** Standard measurements are obviously not of great value where continuously polymorphic species are involved, as one size grades into another without any break. However, when graphs of the relationships of various dimensions are plotted a number of allometric relationships become apparent. Most easily noticeable of these are the following. The CI increases with increase in HW; the relative lengths of the scapes (SI) decrease as HW increases; the frontal carinae increase in length and strength as HW increases. The size of the eye has little or no dependence on the size of the head, the eyes of the largest workers being relatively only slightly increased in size over those of the smallest (as expressed by the ratio of ocular diameter to HW). Overall size range in the species is TL 4.0–8.7, HL 0.96–2.24, HW 0.88–2.30, CI 92–104, SL 0.70–1.22, SI 49–80, PW 0.68–1.40, AL 1.34–2.50 (85 measured).

Basic characters as given under generic diagnosis, differentiation from *cryptoceroides* as tabulated above. Mandibles pitted, the surface between the pits finely and densely shagreened to finely striate. Frontal carinae increasing in length and strength with increasing worker size (Figs 5–7). In smallest workers short, ending in

front of the level of the anterior margins of the eyes, forming a short and narrow laterally projecting flange on each side and only very slightly divergent. In larger workers the frontal carinae lengthening and becoming more obviously divergent, the laterally projecting flange broadening. In largest workers the carinae reaching back beyond the level of the eyes, divergent to eye level then becoming almost parallel, the laterally projecting flange very prominent throughout most or all of the length of the carinae. Antennal scrobes absent in small workers, becoming better defined with increased size; in large workers the scrobe conspicuous, narrow but quite deep and capable of accommodating the scape. Change in head shape with increased size as in Figs 5–7. Maximum diameter of eye 0.18–0.36, about 0.14–0.20 × HW, the relative size of the eyes not radically increased in larger workers. Outline shape of alitrunk as in Figs 3, 4. Propodeal spines very variable in length, thickness and degree of curvature. In dorsal view the spines not projecting outwards in their basal portions, the propodeal spiracle or at least its annulus visible from above. In profile the propodeal spiracle some distance away from the margin of the declivity below the spine, the diameter of the spiracle less than the distance separating it from the margin of the declivity. Petiolar teeth conspicuous, varying in length and thickness. Sculpture in general increasing in intensity and frequently also in density from smaller to larger workers. Dorsum of head with scattered shallow pits, the surface between them varying from smooth or almost smooth to densely reticulate-punctate. This ground-sculpture is overlaid between the frontal carinae by fine dense longitudinal striation. As the frontal carinae increase in length so the area of striate sculpture becomes stronger and extends further back on the head. In larger specimens the space between the frontal carinae becomes strongly rugose or costate and this sculpture may reach back almost to the occipital margin. Sides of head densely reticulate-punctate everywhere. With increasing size there is a tendency for the progressive encroachment of rugulose sculpture across the reticulate-punctate surface from the front to the back of the sides. Small workers have only the punctate sculpture but as size increases rugulae appear anteriorly which gradually strengthen and spread further back on the head. Pronotal dorsum longitudinally rugose at least centrally, the rugae varying in intensity and sometimes divergent posteriorly. Ground-sculpture reticulate-punctate and usually distinct, sometimes faint and frequently with larger superimposed punctures present. Pronotal sculpture continuing onto mesonotum in smaller workers, but in larger individuals (and also in some smaller ones) the sculpture becomes reduced on the mesonotum so that only the punctate ground-sculpture is present or rugae occur but are restricted to the anterior part of the sclerite. In large workers there is usually a striking reduction in mesonotal sculpture so that most or all of the dorsum is feebly punctulate or even smooth and shining. Propodeal dorsum densely reticulate-punctate, usually without trace of rugulose sculpture but sometimes with one or two weak rugulae present. Petiole, postpetiole and first gastral tergite finely and very densely reticulate-punctate to densely shagreened. Dorsal surfaces of body without standing hairs of any description. Colour very variable, ranging from dull yellowish brown to blackish brown but most commonly bicoloured, with head and alitrunk reddish, gaster dark brown to black. In some the head alone reddish and the rest of the body darker, in others the head and gaster dark and the alitrunk lighter.

#### MATERIAL EXAMINED

**Ghana:** Tafo (B. Bolton); Mampong (P. Room); Bunso (D. Leston); Wiawso (D. Leston); Legon (D. Leston); Mepom (D. Leston); Okumaning (D. Leston). **Nigeria:** Gambari (B. Bolton); Mokwa (C. Longhurst). **Cameroun:** Nkoemvon (D. Jackson). **Zaire:** Yangambi (N. L. H. Krauss); Lukolela to Basoko (H. O. Lang). **Sudan:** Keilak (R. C. H. Sweeny). **Kenya:** Kibwesi (S. A. Neave). **Uganda:** Masindi (R. Lucius). **Tanzania:** Kilossa (S. A. Neave); Morogoro (A. Loveridge); Zanzibar (W. M. Aders); Zanzibar (L. F. Brown); Duthumi (A. Loveridge); Kigoma Reg., Mahale Mts. (S. Uehara). **Zambia:** N'Changa (C. T. Macnamara); Mwendwa (Dollman). **Malawi:** Port Herald (J. E. S. Old). **Zimbabwe:** Umgusa Riv., Sipopoma (G. Arnold); Victoria Falls (G. Arnold).

### *BARACIDRIS* gen. n.

(Figs 12–14)

Type-species: *Baracidris meketra* sp. n.

**DIAGNOSIS OF WORKER.** Minute monomorphic myrmicine ants. Outline shape of head as in Figs 13, 14. Mandibles narrow, the apical (masticatory) margin armed with 5 teeth which decrease in size from apical to basal, the two basalmost teeth small. Basal borders of mandibles unarmed; the mandibles enclosing a space between their basal borders and the anterior clypeal margin when their apical margins are overlapping. Palp formula 2, 2, the first maxillary palpomere small (worker and queen of *meketra* dissected). Median portion of clypeus sharply raised centrally and in the form of a narrow longitudinal ridge which runs from the anterior margin to the frontal lobes. Anterior clypeal margin projecting medially (*meketra*) or in the form of a

truncated lobe (*sitra*). Lateral portions of clypeus unmodified, not prominent not raised into a wall in front of the antennal insertions. Frontal lobes small, very closely approximated, almost touching anteriorly and separated only by the extremely narrow strip of the median clypeus which is inserted between them. The frontal lobes end immediately behind the antennal fossae; frontal carinae and antennal scrobes are absent. Antennae with 12 segments, the flagellum ending in a strong 2-segmented club of which the apical segment is much the larger. Scapes short, when laid back on the head conspicuously failing to reach the occipital margin. Eyes minute and inconspicuous, situated approximately at the midlengths of the sides of the head. Alitrunk and pedicel segments as in Fig. 12. Promesonotum fused and forming a single long shallow convexity in profile. Metanotal groove impressed. Propodeum short, much shorter than the promesonotum, armed with a pair of blunted, broad but short, triangular teeth. Metapleural lobes very broad and rounded, strongly prominent, linked to the propodeal teeth above by a lamella. Petiole nodiform with a short, thick anterior peduncle; in dorsal view the peduncle about as broad as the node. Postpetiole with a strongly projecting blunt or truncated ventral process in profile; cylindrical in dorsal view. Standing hairs absent from dorsal surfaces of head and body, present only on the clypeus and gastral apex.

Known from two species, the minute ants of the genus *Baracidris* seem to be endemic in the wet forest zones of West and Central Africa where they inhabit the leaf-litter and topsoil layers. The genus most closely related to *Baracidris* is *Adelomyrmex* Emery whose known distribution includes the Neotropics, New Guinea, Fiji and Samoa. One of the African species was wrongly referred to *Adelomyrmex* in an earlier publication (Bolton, 1973a). *Adelomyrmex* shares a number of diagnostic characters with *Baracidris*, particularly in having similarly constructed antennae of 12 segments ending in a large 2-segmented club. Differences separating the genera may be tabulated as follows.

*Baracidris**Adelomyrmex*

Basal border of mandibles unarmed.

Basal border of mandibles with a tooth at or proximal to the midlength of the border.

Maxillary palp 2-segmented.

Maxillary palp 1-segmented (Gotwald, 1969).

Median strip of clypeus raised into a narrow ridge; anterior clypeal margin unmodified or with a simple lobe.

Median portion of clypeus swept upwards into a strongly raised sharp-edged longitudinal platform which projects sharply forwards into a lobe; anterior clypeal margin sweeping downwards and outwards away from and behind the apex of this lobe.

Hairs absent from dorsal surfaces of head and body.

Hairs present on dorsal surfaces of head and body.

Postpetiole short-cylindrical in dorsal view, with a large truncated ventral process.

Postpetiole not short-cylindrical in dorsal view, usually without a truncated ventral process.

Petiole low in profile.

Petiole usually high and narrow in profile, only rarely low.

Metapleural lobes very large and continuous with the propodeal teeth above.

Metapleural lobes small, separated from the propodeal spines above.

Range: West & Central Africa.

Range: Neotropics, New Guinea, Fiji, Samoa.

Among the Myrmicinae of the Ethiopian zoogeographical region *Baracidris* is unique in possessing 12-segmented antennae with a 2-segmented club. This character, coupled with the very closely approximated frontal lobes with the median clypeus narrowly inserted between them, the short 5-dentate mandibles, reduced palp formula of 2, 2 and the shape of the pedicel segments, renders *Baracidris* quickly recognizable. The key presented below will separate the myrmicine genera of the region which have a conspicuously 2-segmented antennal club. *Crematogaster* is included as a few species have such a club although the vast majority of species in this genus have the club 3-segmented.

**Key to genera of Ethiopian region Myrmicinae with 2-segmented antennal club (workers)**

- |   |   |   |
|---|---|---|
| 1 | Mandibles elongate and linear, produced into long narrow projecting blades; never triangular/subtriangular, never serially dentate  | 2 |
| – | Mandibles triangular or subtriangular, not produced into long narrow projecting blades; apical (masticatory) margins usually serially dentate but teeth sometimes reduced | 6 |

- 2 Apex of each mandibular blade armed with a fork of 2-3 spiniform teeth set in a more or less vertical series, with or without denticles between these teeth . . . . . 3
- Apex of each mandibular blade either with a single long tooth at the dorsal apex subtended by a series of denticles, or with a series of denticles only . . . . . 5
- 3 Apical fork of mandibles with 3 spiniform teeth. Blades of mandibles without preapical teeth. Petiole node with a pair of teeth or short spines. Antennal scrobes absent . . . . . *MICRODACETON* Santschi
- Apical fork of mandibles with 2 spiniform teeth. Blades of mandibles with preapical teeth. Petiole node unarmed. Antennal scrobes present . . . . . 4
- 4 Antennae with 4 segments. Head with large orbicular hairs present. Mandibles very strongly bowed, with a single preapical spiniform tooth . . . . . *QUADRISTRUMA* Brown
- Antennae with 6 segments. Head without orbicular hairs. Mandibles not strongly bowed, with preapical armament of 1-2 teeth or denticles . . . . . *STRUMIGENYS* F. Smith
- 5 Head with large orbicular hairs present; clypeal margin with spatulate or strap-like projecting hairs. Antennal scape with a broad anteriorly projecting lobe. Head shield-like and broad . . . . . *EPITRITUS* Emery
- Head with simple hairs; clypeal margin without spatulate or strap-like projecting hairs. Antennal scape linear, without broad anteriorly projecting lobe. Head not shield-like, longer than broad . . . . . *CLADAROGENYS* Brown
- 6 Antennae with 4-6 segments . . . . . 7
- Antennae with 8-12 segments . . . . . 12
- 7 Antennal scrobes absent. Propodeum unarmed, smoothly rounded. Basal tarsal segment on each leg (but especially the first) very strongly swollen . . . . . *MELISSOTARSUS* Emery
- Antennal scrobes present above the eye. Propodeum bidentate or bispinose. Basal tarsal segment on each leg slender . . . . . 8
- 8 Clypeus very large, covering most of mandibles so that only their apices are visible in full-face view, the mandibles thus appearing very short. Dorsal surfaces of head capsule and body hairless but specialized hairs present on clypeus and scapes . . . . . *MICCOSTRUMA* Brown
- Clypeus smaller, not covering most of mandibles; in most cases merely covering the basal borders so that the whole length of the mandible is visible in full-face view. Dorsal surfaces of head and body usually conspicuously hairy . . . . . 9
- 9 Apical margin of mandible with > 20 denticles, the basal 4-8 of which may be enlarged . . . . . *SERRASTRUMA* Brown
- Apical margin of mandible with < 10 teeth of variable size . . . . . 10
- 10 With mandibles fully closed their basal borders separated from the anterior clypeal margin by a conspicuous impression or gap. Cephalic hairs reduced to 2-3 on posterior dorsum . . . . . *TRICHOSCAPA* Emery
- With mandibles fully closed their basal borders contiguous with or overlapped by the anterior clypeal margin. Cephalic hairs numerous . . . . . 11
- 11 Mandibles very strongly convex and downcurved, armed with relatively few, strongly developed, stout teeth . . . . . *CODIOMYRMEX* Wheeler
- Mandibles not strongly convex nor downcurved, armed with numerous small spiniform teeth or denticles . . . . . *SMITHISTRUMA* Brown
- 12 Antennae with 8-9 segments . . . . . 13
- Antennae with 10-12 segments . . . . . 15
- 13 Propodeum bidentate, bispinose or sharply angled. Dimorphic species . . . . . *OLIGOMYRMEX* Mayr (part)
- Propodeum unarmed. Monomorphic species . . . . . 14
- 14 Eyes absent. Mandibles with 5-6 teeth. Promesonotum not marginate laterally . . . . . *CAREBARA* Westwood
- Eyes present. Mandibles with 4 teeth. Promesonotum marginate laterally . . . . . *PAEDALGUS* Forel
- 15 Postpetiole articulated on dorsal surface of first gastral segment. Petiole dorsoventrally flattened and without a node . . . . . *CREMATOGASTER* Lund
- Postpetiole articulated on anterior surface of first segment. Petiole with a node of some form . . . . . 16
- 16 Propodeum unarmed and rounded. Antennae with 10 segments . . . . . *SOLENOPSIS* Westwood
- Propodeum bidentate or bispinose. Antennae with 10-12 segments . . . . . 17
- 17 Frontal lobes very close together so that the portion of the clypeus running between them is extremely narrow, reduced to a line. Antennae with 12 segments . . . . . *BARACIDRIS* gen. n.
- Frontal lobes not very close together, the portion of the clypeus running between them not reduced to a line. Antennae with 10-11 segments . . . . . 18

- 18 Clypeus bicarinate. Dimorphic species without intermediates . . . . . *OLIGOMYRMEX* Mayr (part)  
 – Clypeus not bicarinate. Polymorphic species . . . . . *PHEIDOLOGETON* Mayr

### List of species

*meketra* sp. n.

*sitra* sp. n.

### Key to species (workers)

- 1 Central portion of anterior clypeal margin not produced into a narrow truncated lobe (Fig. 13).  
 Occipital margin in full-face view indented or concave medially. Head slightly narrower and antennal scapes relatively longer, CI 80–82, SI 75–79. (Ivory Coast, Ghana, Nigeria) *meketra* (p. 255)  
 – Central portion of anterior clypeal margin produced into a narrow truncated lobe (Fig. 14).  
 Occipital margin in full-face view not indented or concave medially. Head slightly broader and antennal scapes relatively shorter, CI 86, SI 70. (Gabon) . . . . . *sitra* (p. 256)

### Treatment by species

#### *Baracidris meketra* sp. n.

(Figs 12, 13)

HOLOTYPE WORKER. TL 1·8, HL 0·44, HW 0·36, CI 82, SL 0·28, SI 78, PW 0·26, AL 0·50.

Mandibles sculptured with fairly large scattered pits, shining, without striate sculpture. Apical tooth of mandible large, the second smaller, the remaining three teeth very small. Anterior clypeal margin projecting forwards medially but not forming a narrow truncated lobe. Structure of clypeus and frontal lobes as given in generic diagnosis. Antennal scapes short and stout (SI 75–79 in entire type-series), when laid back on the head distinctly failing to reach the occipital margin. First funicular segment large, longer than broad; segments 2–9 of funiculus annular and distinctly broader than long. The two apical funicular segments which form the strong club dissimilar in size, the preapical much shorter than the apical (0·05 as opposed to 0·22). Eye minute, with a single ocellus of diameter *c.* 0·015 – 0·020, approximately 0·05 × HW. With head in full-face view the occipital margin indented or slightly concave medially. Promesonotum forming a single long shallow convexity in profile, the metanotal groove impressed. Propodeal dorsum in profile feebly convex and sloping posteriorly to the short but quite broad triangular teeth. The propodeal teeth are joined by a lamella below to the enlarged, strongly prominent and very broadly rounded plate-like metapleural lobes, the two together forming an efficient shield all down the propodeal declivity. Propodeal spiracle round. With alitrunk in dorsal view the promesonotum three times longer than the propodeum (0·32 and 0·10 respectively), the pronotal shoulders broadly rounded. Propodeal dorsum terminating posteriorly in a sharply defined arch between the bases of the laterally flattened teeth, the declivity almost vertical and bounded on each side by the very prominent teeth and metapleural lobes, and the lamella which links them. A single small carina traverses the declivity at the level of the propodeal teeth. Petiole in profile with a short, thick anterior peduncle which is distinctly shorter than the length of the node; the peduncle with a small anteroventral process. Postpetiole in profile with the sternite produced into a large truncated ventral process. In dorsal view the petiole node as long as broad (*c.* 0·12), the anterior peduncle broader than long and much shorter than the dorsal length of the node; the node itself scarcely broader than the peduncle. Postpetiole dorsally slightly broader than long, about equal in length to the petiole node and parallel-sided, appearing short-cylindrical. Base of first gastral tergite concave at the postpetiolar articulation. Dorsum and sides of head with small, close-packed foveolate punctures, the spaces between which are smooth and shining. Spaces between punctures usually smaller than the diameter of the punctures. On the sides of the head above and behind the eyes there is a tendency for the punctures to be aligned. Dorsal alitrunk similarly sculptured but the punctures less conspicuous and more widely scattered, with extensive smooth shining spaces between them. Sides of alitrunk and all surfaces of pedicel segments punctate, denser on the metapleuron than elsewhere on the alitrunk and denser on the sides of the petiole and postpetiole than dorsally. First gastral tergite unsculptured except for scattered minute punctulae. Hairs absent except on clypeus, mouthparts and gastral apex. All dorsal surfaces of head and body thin and sparsely clothed with extremely fine short appressed pubescence. Colour uniform light brown, the appendages lighter in shade than the body.

PARATYPE WORKERS. TL 1·7–1·8, HL 0·44–0·47, HW 0·36–0·38, CI 80–82, SL 0·27–0·30, SI 75–79, PW 0·26–0·28, AL 0·49–0·50 (4 measured). As holotype but the Ghana specimens slightly darker in colour

than those from Nigeria and with the cephalic sculpture somewhat more sharply defined. Propodeal teeth vary slightly in length and width but are always shorter than the metapleural lobes. One or two fine transverse carinae may be present on the propodeal declivity, between the teeth.

PARATYPE FEMALE (dealate). TL 2.0, HL 0.46, HW 0.39, CI 85, SL 0.28, SI 72, PW 0.30, AL 0.56. As worker but eyes larger (maximum diameter 0.10,  $c. 0.26 \times HW$ ) and with ocelli present. Alitrunk with full complement of flight sclerites, the pronotum forming a clearly visible collar anteriorly in dorsal view. Mesoscutellum much higher than and somewhat overhanging the propodeal dorsum. Mesoscutum and scutellum with foveolate punctures and a smooth unsculptured median longitudinal strip; otherwise as holotype.

Holotype worker, **Nigeria**: Ile-Ife, 21.vii.1971 (*J. T. Medler*) (BMNH).

Paratypes. **Nigeria**: 1 worker with same data as holotype. **Ghana**: 1 worker and 1 dealate female, Tafo, 4.ix.1970, cocoa litter sample (*B. Bolton*). **Ivory Coast**: 1 worker, Abidjan, Banco Forest, i.1963 (*W. L. Brown*) (BMNH; MCZ, Cambridge).

All specimens originated in forest; those from Ghana were extracted from a sample of cocoa leaf litter which had built up between the roots of a large forest tree, left in the plantation to provide shade for the cocoa.

### *Baracidris sitra* sp. n.

(Fig. 14)

HOLOTYPE WORKER. TL 2.0, HL 0.51, HW 0.44, CI 86, SL 0.31, SI 70, PW 0.31, AL 0.56.

Answering to the description of *meketra* above as regards general shape, sculpture etc., but differing as follows.

Anterior clypeal margin produced into a short truncated simple lobe. Occipital margin of head in full-face view transverse or exceedingly feebly convex, not indented or concave medially. Larger, more stockily built species with relatively broader head and shorter antennal scapes—compare standard measurements. Apart from these the lengths of apical and preapical funicular segments in *sitra* are 0.26, 0.07 respectively, and the dorsal lengths of promesonotum and propodeum are 0.35, 0.12 respectively. Petiole node in dorsal view slightly broader than long (0.13 by 0.10). Propodeal dorsum more strongly convex and the lamella linking the teeth to the metapleural lobes broader, minimum width of the lamella 0.06 (as opposed to 0.03 in *meketra* holotype).

Holotype worker, **Gabon**: Plateau d'Ipassa, VM9, IPA7 (*J. A. Barra*) (MCZ, Cambridge).

The two minute species of this genus are closely related, but the first and second characters noted above, plus the differences in dimensions, serve to separate them. Like most of the *meketra* material the holotype and only known specimens of *sitra* seems to come from a leaf-litter sample.

### CYPHOIDRIS Weber

(Figs 15–17)

*Cyphoidris* Weber, 1952: 26. Type-species: *Cyphoidris spinosa* Weber, loc. cit.; by original designation.

DIAGNOSIS OF WORKER. Monomorphic myrmicine ants. Mandibles triangular with an elongate apical (masticatory) margin bearing 10–14 small teeth or denticles which decrease in size from apex to base. Palp formula 4, 3. Median portion of clypeus narrow and raised, bicarinate above and narrowly inserted between the frontal lobes. Lateral portions of clypeus unmodified, not forming a shield-wall or raised ridge in front of the antennal insertions. Frontal lobes not strongly expanded but covering the antennal insertions, prolonged posteriorly as a pair of strongly developed frontal carinae which form the dorsal margins of a pair of strong and conspicuous broad scrobes; the scrobes run back almost to the occiput. Ventral margin of scrobe a longitudinal ridge or ruga running above the eye, the latter of moderate size and situated in front of the midlength of the sides. Antennae 11-segmented, with a conspicuous 3-segmented club apically. Alitrunk in profile with promesonotum fused and swollen, the dorsum dome-like and strongly convex in outline, much elevated above the level of the propodeum. Propodeum bispinose; the spiracle close to the margin of the declivity, the orifice circular and directed posteriorly. Metapleural lobes low and triangular. Petiole with an elongate anterior peduncle and well developed node. Sting terminating in a narrow spatulate appendage apically.

An easily defined genus, *Cyphoidris* is the only African representative of a group of genera centring on *Lordomyrma* Emery, most of which have an Indo-Australian or Neotropic distribution. *Cyphoidris* is close to *Lordomyrma* itself but differs as the latter has 12-segmented antennae, a reduced palpomere count, and has the propodeal spiracle set well forward from the margin of the declivity. Of the known species of *Cyphoidris*, *exalta* and *spinosa* are of Central African origin and inhabit the leaf litter layer; *parissa* originates in West Africa, and *weneri* is the only known East African representative of the genus.

### List of species

*exalta* sp. n.

*parissa* sp. n.

*spinosa* Weber

*weneri* sp. n.

### Key to species (workers)

- |   |  |                         |
|---|--|-------------------------|
| 1 | Basal half of first gastral tergite densely and strongly shagreened. (Liberia)   | <i>parissa</i> (p. 258) |
| – | Basal half of first gastral tergite unsculptured except for hair-pits  | 2                       |
| 2 | Propodeal dorsum flat in profile, not continuing curve of mesonotum. Dorsal alitrunk not strongly densely reticulate-rugose everywhere | 3                       |
| – | Propodeal dorsum in profile continuing curve of mesonotum. Dorsal alitrunk strongly densely reticulate-rugose everywhere. (Rwanda)     | <i>weneri</i> (p. 259)  |
| 3 | Dorsal alitrunk with abundant conspicuous standing hairs (Fig. 15). (Ivory Coast, Zaire, Angola)                                       | <i>spinosa</i> (p. 257) |
| – | Dorsal alitrunk with inconspicuous short decumbent hairs (Fig. 17). (Cameroun)   | <i>exalta</i> (p. 258)  |

### Treatment by species

#### *Cyphoidris spinosa* Weber

(Figs 15, 16)

*Cyphoidris spinosus* Weber, 1952: 26, figs 7, 8. Holotype worker, ZAIRE: Ituri Forest, 15 miles [24 km] N. of Beni, 25.ii.1948, no. 2129-2 (*N. A. Weber*) (AMNH, New York) [examined].

WORKER. TL 3.8–4.3, HL 0.90–0.98, HW 0.81–0.91, CI 88–93, SL 0.68–0.76, SI 83–86, PW 0.60–0.72, AL 1.08–1.22 (10 measured).

Mandibles smooth with scattered pits or at most with faint traces of fine longitudinal striation; number of small teeth on mandible varying from 10–12. Anterior clypeal margin arcuate or with a very shallow impression medially, the median portion of the clypeus raised and bicarinate longitudinally. Main features of head as in generic diagnosis and Fig. 16. Eyes of moderate size, maximum diameter 0.16–0.18, about 0.20–0.22 × HW, situated below the ventral margin of the scrobe and in front of the midlength of the sides of the head. Frontal carinae sharply defined, relatively close together and diverging slightly posteriorly but in general not becoming radically broader than the distance across the frontal lobes. At eye level the separation of the frontal carinae is 0.36–0.42, about 0.44–0.46 × HW.

Outline of alitrunk as in Fig. 15, the promesonotum conspicuously swollen and on a much higher level than the propodeal dorsum. Propodeum armed with a pair of strong spines which are straight to feebly upcurved. Metanotal groove absent; metapleural lobes triangular and conspicuous. Petiole in profile with an elongate peduncle and a well developed node, the dorsum of the node sloping downwards posteriorly so that the posterior face is short. Anterior and dorsal surfaces of postpetiole forming a single convexity, the posterior face truncated. In dorsal view the nodes of both the petiole and postpetiole broader than long. Dorsum of head strongly longitudinally rugose, with 5–7 rugae between the frontal carinae at eye-level. The rugae are irregular and tend to meander slightly, a few anastomoses usually being present. Scrobal area for the most part smooth but usually with 1–2 fine rugulae traversing the width of the scrobe behind the antennal fossa. Sides of head behind eyes finely reticulate-rugose, this sculpture extending round the posterior margins of the scrobes to the occiput. Spaces between rugae everywhere on head unsculptured or at most with the faintest superficial traces. Dorsal alitrunk everywhere finely but strongly reticulate-rugose with broad shining interspaces. Petiole dorsum rugulose, the postpetiole varying from rugulose to only faintly sculptured. Gaster unsculptured. All dorsal surfaces of head and body densely clothed with fine acute hairs. Colour dark reddish brown to blackish brown.

*C. spinosa*, known only from Zaire, Ivory Coast and Angola, is a leaf litter inhabiting species of the forest zone. The closest related species of the genus, *exalta*, is compared with *spinosa* below.

MATERIAL EXAMINED

**Angola:** Duque de Bragança Falls (*P. M. Hammond*). **Ivory Coast:** Agboville (*I. Löbl*).

*Cyphoidris exalta* sp. n.

(Fig. 17)

HOLOTYPE WORKER. TL 4.3, HL 0.96, HW 0.88, CI 92, SL 0.74, SI 84, PW 0.64, AL 1.16.

Answering to the description of *spinosa* in general characters but differing markedly in sculpture and pilosity, as follows.

<i>exalta</i>	<i>spinosa</i>
Sides of pronotum smooth.	Sides of pronotum reticulate-rugose.
Promesonotal dorsum weakly and predominantly transversely rugulose, with few meshes.	Promesonotal dorsum strongly and conspicuously reticulate-rugose.
Postpetiole in dorsal view unsculptured.	Postpetiole in dorsal view sculptured.
Occipital corners without long fine hairs.	Occipital corners each with a single long fine hair which is prominent and conspicuous.
Occipital margin and sides of head behind eyes with short, curved, decumbent to appressed hairs.	Occipital margin and sides of head behind eyes with projecting curved hairs.
Dorsal margins of frontal carinae without a spaced row of long curved hairs; such hairs also absent elsewhere on head where only very short, curved pilosity is present.	Dorsal margins of frontal carinae with a spaced row of long curved hairs, such hairs also present elsewhere on head and projecting freely above the level of the shorter ground-pilosity.
Dorsal surfaces of alitrunk, petiole and postpetiole with inconspicuous short, curved decumbent hairs (Fig. 17).	Dorsal surfaces of alitrunk, petiole and postpetiole with conspicuous long standing hairs (Fig. 15).
First gastral tergite with short curved hairs.	First gastral tergite with elongate projecting hairs.

PARATYPE WORKER. TL 4.2, HL 0.95, HW 0.85, CI 89, SL 0.74, SI 87, PW 0.62, AL 1.12. As holotype.

Holotype worker, **Cameroun:** Korup Reserve, 14.ii.1980, in rotten log (*D. Jackson*) (BMNH).

Paratype. 1 worker with same data as holotype (MCZ, Cambridge).

*Cyphoidris parissa* sp. n.

HOLOTYPE WORKER. TL 3.7, HL 0.84, HW 0.76, CI 90, SL 0.62, SI 82, PW 0.58, AL 1.00.

Mandibles smooth with scattered small pits, the apical margin armed with 11–12 low denticles. Anterior clypeal margin convex but medially slightly flattened and apparently with a minute median indentation. Median portion of clypeus raised and the raised section bicarinate above. Frontal carinae strongly developed, running back beyond the level of the eyes but fading out well in front of the occipital margin, forming the dorsal borders of the broad but shallow conspicuous scrobes. Frontal carinae slightly diverging posteriorly, their separation at the level of the midlengths of the eyes only c. 0.30, about 0.40 × HW. Eyes distinctly longer than wide, their maximum diameter 0.18, about 0.24 × HW. With the head in full-face view the sides rounding broadly and evenly into the occipital margin, without trace of an occipital corner; the occipital margin itself evenly shallowly convex, not impressed or concave medially. Alitrunk in profile with the promesonotum strongly swollen and dome-like, much higher than the surface of the propodeum; the latter sloping posteriorly to a pair of narrow spines which are very feebly sinuate along their length. Metapleural lobes short-triangular and acute. Petiole node in profile with the anterior face higher than the posterior so that the dorsal surface slopes downwards posteriorly; posterodorsal angle of node more obtuse than anterodorsal angle. Postpetiole with a sharp anteroventral dentiform process (which is seen in ventral view as a short transverse flange). In dorsal view both petiole node and postpetiole broader than long. Dorsum of head unsculptured except for a median carina between the frontal carinae and some extremely faint vestiges of feeble sculpture between the frontal carinae. Alitrunk unsculptured and shining. Petiole and postpetiole unsculptured, the latter with traces of punctulate sculpture posteriorly. First gastral tergite densely, strongly and conspicuously shagreened on the basal half, this sculpture fading out apically on the



sclerite. Dorsum of head with numerous short fine curved hairs. Dorsal alitrunk and pedicel segments without hairs but with scattered sparse short pubescence which is appressed and very inconspicuous. First gastral tergite without hairs but with a fairly dense coat of short appressed pubescence superimposed upon the shagreened surface of the sclerite and quite conspicuous. Scapes and tibiae with pubescence but without hairs. Colour dark reddish brown, the gaster darker in shade than the head.

Holotype worker, **Liberia**: Gibi, Smithsonian Firestone Exp. 1940 (*W. M. Mann*) (USNM, Washington).

The only known representative of *Cyphoidris* from West Africa, *parissa* is easily separated from both its Central African congeners by its lack of strong cephalic sculpture, unsculptured alitrunk, strongly shagreened first gastral tergite, lack of hairs on the dorsal body behind the head, and presence of a sharp subpostpetiolar process.

### *Cyphoidris weneri* sp. n.

HOLOTYPE WORKER. TL 3·7, HL 0·91, HW 0·83, CI 91, SL 0·62, SI 75, PW 0·63, AL 1·08.

Mandibles smooth and shining with scattered small pits, the apical margin armed with 10–11 small denticles. Anterior margin of clypeus conspicuously impressed medially. Narrow median portion of clypeus bicarinate above. Frontal carinae strongly developed and forming the dorsal margins of the broad but shallow antennal scrobes, the carinae diverging posteriorly and fading out well before reaching the occipital margin. Separation of the frontal carinae at the level of the midlengths of the eyes *c.* 0·37, about 0·45 × HW. Eyes longer than wide, their maximum diameter 0·17, about 0·20 × HW. Alitrunk with promesonotum swollen but not more or less evenly convex in profile as is usual in the genus. Instead there is a long plateau-like dorsum which is much less strongly convex than the ascending face of the pronotum in front or the descending face of the mesonotum behind. Propodeal dorsum in profile continuing the downward slope of the mesonotum, the surfaces not separable. Propodeal spines with their extreme apical portions upcurved. Metapleural lobes low and broadly triangular. Alitrunk in dorsal view broadest across the pronotal shoulders, evenly narrowing posteriorly. Petiole node low and quite small in profile, its dorsal surface sloping downwards posteriorly and the anterodorsal angle better defined than the posterodorsal which tends to round into the posterior face. In dorsal view nodes of both petiole and postpetiole conspicuously broader than long and the latter much broader than the former. Dorsum of head predominantly longitudinally rugose, the rugae irregular and with cross-meshes developing behind the level of the eyes. Cross-meshes increase in density posteriorly and a rugoreticulum is present occipitally. Sides of head below the scrobes finely reticulate-rugose, the scrobes themselves much less strongly sculptured than the rest of the head, being mostly smooth with a few feeble transverse rugulae. Entire dorsum of alitrunk very densely strongly and closely reticulate-rugulose, the reticular meshes small and the rugulae raised so that in places the surface appears reticulate-foveolate. Dorsal surfaces of rugulae with a beaded appearance due to presence of aligned minute punctures; the entire surface blanketed with sculpture, without smooth areas. Sides of alitrunk similarly but more loosely sculptured, the pleurae and sides of propodeum with smooth areas between the more widely separated rugulae. Propodeal declivity smooth, with vestiges of transverse rugulae between the spines. Nodes of petiole and postpetiole both dorsally and laterally sculptured as dorsal alitrunk. First gastral tergite unsculptured except for fairly conspicuous pits from which hairs arise. All dorsal surfaces of head and body densely clothed with short fine curved hairs which are subdecumbent to decumbent. Long hairs absent except on clypeus and a row on the upper surface of each frontal carina. Colour blackish brown with a dull reddish tint, the latter most apparent on the sides of the alitrunk. Antennae and legs dull orange-yellow.

PARATYPE WORKERS. TL 3·5–3·8, HL 0·84–0·92, HW 0·76–0·84, CI 90–93, SL 0·60–0·66, SI 74–79, PW 0·58–0·64, AL 0·98–1·08 (14 measured). As holotype but maximum diameter of eye 0·15–0·17, about 0·18–0·20 × HW.

Holotype worker, **Rwanda**: Rangiro, ix.1976, litter (*P. Werner*) (MHN, Geneva).

Paratypes. 14 workers with same data as holotype (MHN, Geneva; BMNH; MCZ, Cambridge).

*C. weneri* is the only known species of this genus from East Africa. It is easily distinguished from its congeners in West and Central Africa by its strong blanketing alitrunkal sculpture and by the fact that the propodeal dorsum continues the steep slope of the posterior part of the mesonotum. Apart from these features *weneri* lacks the gastral shagreening typical of *parissa*, is much more densely hairy than *exalta*, and has shorter scapes and generally much coarser sculpture than *spinosa*.

*OCYMYRMEX* Emery

(Figs 18–32)

*Ocymyrmex* Emery, 1886: 364. Type-species: *Ocymyrmex barbiger* Emery, loc. cit.; by monotypy.

**DIAGNOSIS OF WORKER.** Monomorphic myrmicine ants. Mandibles short and powerful, armed with five sharp teeth which decrease in size from apex to base. The third and fourth teeth, counting from the apical, are paired, having flanking teeth internally on the masticatory margin which are only visible when the mandibles are open. Palp formula 4, 3 in *barbiger*, but 3, 3 is the predominant count (thus in *ankhu*, *celer*, *foreli*, *fortior*, *micans*, *monardi*, *nitidulus*, *phraxus*, *picardi*, *shushan*, *sobek*, *sphinx*, *velox*). Ventral surface of head with a strongly developed psammophore, the ammochaete hairs arising on the gular surface, base of the ventral borders of the mandibles and bases of the mouthparts. Clypeus large, projecting over the basal borders of the mandibles; posteriorly the clypeus broadly inserted between the frontal lobes. Frontal lobes well developed but short, mostly or wholly covering the antennal insertions, ending at the same level as do the antennal fossae; frontal carinae and antennal scrobes absent. Antennae with 12 segments, filiform, without an apical club. Eyes well developed, situated slightly behind the midlength of the sides of the head and usually failing to break the outline of the sides in full-face view. Mesothoracic spiracles opening high on the sides, clearly visible in dorsal view, with a slit-like or crescent-shaped orifice. Propodeal spiracle extremely elongate, slit-shaped and very conspicuous. Propodeum unarmed, rounded in all known species. Legs extremely long and slender, their coxae large and powerful. Petiole with a long narrow anterior peduncle and with a rounded node which is usually low and small. Behind the node a short posterior peduncle is present which runs to the articulation with the postpetiole. Postpetiole low and generally shallowly curved, often voluminous but not usually forming a prominent node. Sting small, perhaps not functional. First segment of gaster often with a narrow neck-like constriction basally (not in *barbiger* and allies), the sides of the tergite usually with a series of roughly transverse, parallel indentations or grooves.

**DIAGNOSIS OF FEMALES (queens).** Extremely ergatoid, answering to all the characters stated above and differing from the workers only slightly, having thicker scapes, broader and more parallel frontal lobes, and usually possessing conspicuous transverse sculpture on the head. Characters normally associated with female ants, such as larger eyes, presence of ocelli, swollen alitrunk with flight sclerites and wings etc., are never developed. Females are discussed in more detail below.

This easily defined and spectacular genus, which has not been revised previously, is confined to the Ethiopian zoogeographical region where its 23 species inhabit dry to semi-desert conditions in the eastern and southern parts of the continent. All the species nest directly into the ground, either in the open or at the bases of plants. In the former case the nest is usually in sandy soil and a crater is formed around the entrance hole. Arnold (1916), who was acquainted with and reviewed the South African species, pointed out the remarkable swiftness of these ants, saying that for speed they far outstrip 'all other ants with which I am acquainted, so much so that they appear almost to fly over the surface of the ground'. Prins (1965) has recorded that *Ocymyrmex* species are granivorous but will also attack and destroy other insects.

In the classification of both Emery (1922) and Wheeler (1922) the genus *Ocymyrmex* is the sole constituent of its own tribe, the Ocymyrmecini, and Kugler's (1978) study of the sting structure does nothing to undermine this view. In general the construction of the head in *Ocymyrmex* suggests affinities with the pheidoline genera, but so many specialized characters are present that this cannot be certain. What does seem certain is that Ocymyrmecini is best retained as a separate tribe. It is easily isolated by the form of the alitrunk spiracles, which are unique amongst the Myrmicinae.

Arnold (1916) and Emery (1922) both recorded that no females of *Ocymyrmex* had ever been found, but they were both aware of the presence of strange variants in a number of nest-series which had transverse sculpture on the head instead of the usual longitudinal form. Several of these variants were described from isolated examples as separate species or subspecies, despite the fact that long ago Arnold (1916) had recorded that they occurred in the same nests as the more normally sculptured form.

It is now apparent that these forms are in fact the ergatoid females of the species; their resemblance to the workers is truly remarkable. Most characters regarded as normal for female ants are absent or have been suppressed, the body is extremely worker-like, without trace of flight sclerites, and the head lacks ocelli or enlarged eyes. The head, however, has three specializations which serve to distinguish the females from their workers; compare Figs 22 and 23.

Firstly, the outer margins of the frontal lobes are more widely separated in their posterior halves in females, and the margins of the frontal lobes behind the level of the antennal insertions are parallel or nearly so, whereas in workers they are obviously convergent behind.

Secondly, the antennal scapes are broader and frequently slightly shorter in females than in workers.

To illustrate these two points all available females were measured for width across the margins of the frontal lobes at their posteriormost point (FW), and the maximum width of the shaft of the scape (SW) discounting the apical swelling when present. The same measurements were taken for an equal number of workers chosen at random from the series in which the respective females originated. These measurements were compared with the standard measures of HW and SL, as follows (where n = number of females measured).

species		HW	FW	FW/HW	SL	SW	SW/SL	
<i>fortior</i>	female	1.68-1.80	0.48-0.54	0.28-0.31	1.48-1.66	0.18-0.19	0.11-0.12	(n = 5)
"	worker	1.72-1.96	0.40-0.46	0.23-0.26	1.46-1.70	0.12-0.16	0.08-0.09	
<i>nitidulus</i>	female	1.67-1.76	0.48-0.52	0.28-0.30	1.40-1.52	0.15-0.16	0.10-0.11	(n = 8)
"	worker	1.72-1.78	0.40-0.44	0.22-0.25	1.48-1.58	0.12-0.14	0.08-0.10	
<i>picardi</i>	female	2.48-2.50	0.70	0.28	2.28-2.36	0.22-0.24	0.09-0.10	(n = 2)
"	worker	2.44-2.60	0.58-0.62	0.24	2.40-2.54	0.18-0.20	0.08	
<i>velox</i>	female	2.08-2.18	0.50-0.56	0.24-0.26	2.08-2.16	0.20-0.22	0.10	(n = 3)
"	worker	2.14-2.18	0.44-0.46	0.20-0.21	0.20-0.26	0.18-0.20	0.08-0.09	
<i>barbiger</i>	female	1.48-1.60	0.44-0.46	0.29-0.30	1.34-1.48	0.16	0.11-0.12	(n = 2)
"	worker	1.52-1.60	0.40-0.44	0.26-0.27	1.40-1.52	0.12-0.14	0.09	
<i>flaviventris</i>	female	1.50-1.64	0.44-0.46	0.28-0.31	1.40-1.48	0.15-0.17	0.11	(n = 3)
"	worker	1.54-1.76	0.36-0.40	0.23-0.24	1.46-1.66	0.12-0.14	0.08-0.09	
<i>weitzeckeri</i>	female	1.64	0.49	0.30	1.42	0.17	0.12	(n = 1)
"	worker	1.60	0.38	0.24	1.42	0.14	0.10	
<i>foreli</i>	female	1.64-1.76	0.50-0.53	0.30	1.52-1.65	0.16-0.18	0.11	(n = 2)
"	worker	1.68-1.76	0.40	0.23-0.24	1.56-1.76	0.14	0.08-0.09	
<i>sobek</i>	female	1.80-1.84	0.50-0.54	0.28-0.29	1.62-1.68	0.17-0.18	0.10-0.11	(n = 4)
"	worker	1.76-1.84	0.42-0.44	0.23-0.24	1.66-1.70	0.14-0.15	0.08-0.09	

Finally, the dorsum of the head behind the level of the eyes usually has strong regular transverse sculpture in females, whereas such sculpture is generally longitudinal in workers. Exceptions to this occur in *robecchii* where both known specimens have transverse sculpture, implying that they are female, but lack the specialized characters of scapes and frontal lobes noted above. They are treated as workers in this paper although it is realized that they may turn out to be females. In *hirsutus* most workers have arched-transverse sculpture on the head, but in this case it is coarse, sharply developed, irregular and vermiculate. In some species (*velox*) the cephalic sculpture is reduced in both castes and may not be apparent.

A few individual workers in any species may show some transverse costulae or rugulae close to the occipital margin, especially in species where the main longitudinal cephalic sculpture arches outwards towards the occipital corners, but none have the extensive transverse sculpture developed by their respective females and their frontal lobes and antennal scapes are of the worker form.

As the females are apterous the founding of new nests must be by colony fission or by single newly mated females setting out on their own. Quite probably a relatively large number of females are retained in the nest at all times as captures are frequent. Whether all females in a colony lay eggs or whether this function is dominated by a single laying female who suppresses the rest is not known, but I suspect the latter as stray females appear to be fairly common in worker samples collected outside the nest and which are, apparently, behaving like workers.

Males, not dealt with here, are very poorly represented in collections, being known only for the species *fortior*, *barbiger* and *weitzeckeri*.

### Synonymic list of species

*ankhu* sp. n.

*barbiger* Emery

*barbatus* Emery

*barbiger* var. *robustior* Stitz **syn. n.**

*barbiger* var. *flavescens* Stitz **syn. n.**

*cavatodorsatus* Prins

*celer* Weber

*cursor* sp. n.

*flaviventris* Santschi **stat. n.**

*foreli* Arnold **stat. n.**

*fortior* Santschi **stat. n.**

*weitzckeri* st. *transversus* Santschi **syn. n.**

*arnoldi* Forel **syn. n.**

*weitzkeri* [sic] st. *abdominalis* Santschi

*weitzaeckeri* [sic] var. *usakosensis* Stitz **syn. n.**

*hirsutus* Forel

*laticeps* Forel

*micans* Forel **stat. n.**

*monardi* Santschi **stat. n.**

*nitidulus* Emery **stat. n.**

*phraxus* sp. n.

*picardi* Forel

*carpenteri* Donisthorpe **syn. n.**

*robecchii* Emery

*shushan* sp. n.

*sobek* sp. n.

*sphinx* sp. n.

*turneri* Donisthorpe

*velox* Santschi

*weitzckeri* Emery

*weitzckeri* subsp. *wroughtoni* Forel **syn. n.**

*zekhem* sp. n.

### Key to species (workers)

- 1 Anterior clypeal margin without a conspicuous semicircular median impression, the margin entire or at most flattened or feebly eroded in the middle . . . . . 2
- Anterior clypeal margin with a conspicuous semicircular median impression, the impression usually flanked by a pair of denticles or teeth . . . . . 8
- 2 With head in full-face view the large eyes ( $0.28 \times \text{HW}$ ) very obviously breaking the outline of the sides (Fig. 25). Middle of anterior clypeal margin with a low, broad bluntly triangular prominence. (South West Africa) . . . . . *turneri* (p. 279)
- With the head in full-face view the smaller eyes ( $< 0.25 \times \text{HW}$ ) failing to break the outline of the sides. Middle of anterior clypeal margin without a triangular prominence . . . . . 3
- 3 First gastral tergite in dorsal view strongly constricted basally and forming a narrow neck, the sclerite in this region roughly parallel-sided and no broader than the postpetiole. Petiole node low and broadly rounded in profile, with a blunt angular ventral process about half-way along the peduncle (Fig. 29) . . . . . 4
- First gastral tergite in dorsal view not constricted basally, without a narrow neck, the sclerite broadening evenly from its articulation with the postpetiole. Petiole node high and domed in profile, without trace of a ventral process at the midlength of the peduncle (Fig. 32) . . . . . 5
- 4 Larger species, HW 2.04, PW 1.30; head narrower, CI 98. Metapleural lobes large and very strongly prominent, plainly visible with alitrunk in absolute profile, not concealed by the bulge of the metapleural glands. (Angola) . . . . . *cursor* (p. 267)
- Smaller species, HW 1.70–1.74, PW 1.08–1.14; head broader, CI 102–103. Metapleural lobes very small, not prominent, scarcely or not visible with alitrunk in absolute profile, mostly or entirely concealed by the bulge of the metapleural glands (Fig. 29). (Angola) . . . . . *laticeps* (p. 271)
- 5 Larger species, HL  $> 2.0$ . Promesonotal outline in profile low and evenly rounded, propodeal

- dorsum more or less flat; dorsal outline of entire alitrunk not saddle-shaped (Fig. 32) . . . . . 6
- Smaller species, HL < 1.50. Promesonotal outline in profile high and dome-like, propodeal dorsum sloping sharply upwards posteriorly; dorsal outline of entire alitrunk strongly saddle-shaped. (South Africa) . . . . . *cavatodorsatus* (p. 266)
- 6 Basal half of first gastral tergite with conspicuous hairs which are as long as those on the mesonotal and propodeal dorsa. Smaller species with longer scapes, HW 1.90, SI 116. Entire ant black to the naked eye, the gaster the same colour as the alitrunk. (South West Africa) . . . . . *zekhem* (p. 281)
- Basal half of first gastral tergite without hairs or at most with 1–2 minute inconspicuous hairs which are much shorter than those on the mesonotal and propodeal dorsa. Larger species with shorter scapes, HW > 2.0, SI range 94–105. Entire ant not black to the naked eye . . . . . 7
- 7 Tricoloured species with alitrunk dull red to blackish red, gaster orange to yellow and head an intermediate shade. Hairs on dorsal alitrunk usually white, only rarely coloured. SI 101–105, CI 95–97 (Angola, South West Africa) . . . . . *velox* (p. 280)
- Colour uniform rich orange-brown, or sometimes with the gaster slightly lighter. Hairs on dorsal alitrunk reddish brown. SI 94–102, CI 97–101. (Angola) . . . . . *ankhu* (p. 265)
- 8 Large or very large species, HW > 2.00, SL > 1.90 . . . . . 9
- Smaller species, HW < 2.00, SL < 1.90 . . . . . 11
- 9 Hairs on dorsal alitrunk dark reddish brown to blackish. Extremely large species, HW 2.30 or more. (Zimbabwe, Botswana, South West Africa, Angola) . . . . . *picardi* (p. 275)
- Hairs on dorsal alitrunk white to silvery. Large species but not approaching the above in size, HW in range 2.02–2.15 . . . . . 10
- 10 Antennal scapes relatively longer, SI > 100 (range 103–106). Dorsum of head behind level of eyes with dense transverse costulate sculpture, ground-sculpture between the costulae vestigial. (Somali Republic) . . . . . *robecchii* (p. 276)
- Antennal scapes relatively shorter, SI < 100 (range 93–98). Dorsum of head behind level of eyes with dense longitudinal rugular sculpture, ground-sculpture between the rugulae a coarse conspicuous punctulation or granulation. (Botswana) . . . . . *sphinx* (p. 278)
- 11 First gastral tergite not constricted basally, not forming a roughly parallel-sided neck behind the postpetiole, the gaster broadening more or less evenly from immediately behind the postpetiole. Palp formula 4, 3. (South Africa, South West Africa) . . . . . *barbiger* (p. 265)
- First gastral tergite constricted basally, forming a roughly parallel-sided neck behind the postpetiole which is no wider than the postpetiole. Palp formula 3, 3 . . . . . 12
- 12 Spaces between costulae on dorsum of head smooth and shining, either without or with only vestigial ground-sculpture; the surface smooth and polished, often with a slick and very shiny appearance. Commonly the costulae themselves are low, rounded and glossy, not sharply defined; sometimes the costulae effaced in places leaving unsculptured areas . . . . . 13
- Spaces between costulae or rugulae on dorsum of head with punctulate or granular ground-sculpture which is conspicuous, the surface not appearing smooth and polished, without a slick and very shiny appearance. Costulae or rugulae on dorsum of head always strongly and often sharply developed, very distinct . . . . . 14
- 13 Pronotum in profile with dorsal outline more or less flat (Fig. 19) or even slightly concave. Head longer and narrower, CI 92–93. (Sudan) . . . . . *celer* (p. 267)
- Pronotum in profile with dorsal outline evenly convex (Fig. 18). Head shorter and broader, CI 96–100. (Ethiopia, Somali Republic, Kenya, Uganda, Tanzania) . . . . . *nitidulus* (p. 274)
- 14 Petiole node much enlarged, swollen in profile and very conspicuous (Fig. 20). Sculpture of petiole node coarse, strongly developed everywhere, with strong coarse rugae running right round the node . . . . . 15
- Petiole node not greatly enlarged (Figs 26–28, 30, 31). Sculpture of petiole node not strongly developed everywhere, usually feebly and unevenly sculptured to unsculptured; commonly with fine or weak rugulae but these only rarely encircling the whole node. A few sharp transverse rugulae may be present dorsally but in this case the node is not much enlarged in profile . . . . . 16
- 15 Alitrunk very dark dull reddish brown or reddish black, usually appearing as black to the naked eye. Gaster yellow or yellowish red, much lighter than and contrasting strongly with the dark alitrunk. Head a shade of dull red intermediate between that of alitrunk and gaster. (Zimbabwe, Botswana) . . . . . *sobek* (p. 277)
- Colour uniform orange-red to red throughout, the gaster usually the same shade as the head and alitrunk but sometimes slightly lighter or darker. (Zimbabwe) . . . . . *foreli* (p. 269)

- 16 Dorsum of head behind level of posterior margins of eyes mostly or wholly sculptured with extremely tightly packed fine rugulae which are sharply and narrowly vermiculate and which are mostly or entirely transverse in direction. (South West Africa) . . . . . *hirsutus* (p. 271)
- Dorsum of head behind level of posterior margins of eyes not sculptured as above, usually with longitudinal costulae or rugulae which may be obscured in some places by dense ground-sculpture. Transverse sculpture usually absent but if a few transverse components are present then they are not sharply and narrowly vermiculate . . . . . 17
- 17 Alitrunk dull brick-red to black . . . . . 18
- Alitrunk yellowish orange to bright red . . . . . 21
- 18 Dorsum of head from inner margin of eye to antennal fossa and the area extending back from this to the occiput blanketed by strong irregular granular sculpture which masks or replaces the costulae or rugulae usually seen in this area. (South West Africa, Angola) . . . . . *monardi* (p. 273)
- Dorsum of head from inner margin of eye to antennal fossa and the area extending back from this to the occiput costulate or rugulose, without blanketing granular sculpture . . . . . 19
- 19 Petiole node in dorsal view very broad, distinctly much broader than long (Fig. 30), the maximum width of the node greater than the length of the petiole from its spiracle to the apex of the collar where it articulates with the postpetiole. (Lesotho, South Africa) . . . . . *weitzckeri* (p. 280)
- Petiole node in dorsal view more slender, at most as broad as long (Figs 26, 27), the maximum width of the node usually distinctly less than the length of the petiole from its spiracle to the apex of the collar where it articulates with the postpetiole . . . . . 20
- 20 Petiole in profile shaped as in Fig. 27, the dorsal surface of the peduncle and the anterior face of the node confluent or nearly so, without a marked change of slope where the two surfaces meet. (Tanzania) . . . . . *phraxus* (p. 274)
- Petiole in profile shaped as in Fig. 26, the dorsal surface of the peduncle and the anterior face of the node not at all confluent, with a marked change of slope where the two surfaces meet. (Zambia, Zimbabwe, Botswana, South Africa, South West Africa, Angola) . . . . . *fortior* (part; p. 269)
- 21 With the alitrunk in profile the promesonotum forming a high dome-like convexity (Fig. 31). (South West Africa) . . . . . *shushan* (p. 277)
- With the alitrunk in profile the promesonotum evenly shallowly convex . . . . . 22
- 22 Sculpture of dorsum of head between eyes and from this level to occiput everywhere longitudinally costulate, not vermiculate nor dominated by coarse punctulate ground-sculpture, the costulae quite regular and evenly spaced. (Zambia, Zimbabwe, Botswana, South Africa, South West Africa, Angola) . . . . . *fortior* (part; p. 269)
- Sculpture of dorsum of head between eyes and from this level to occiput densely finely longitudinally rugulose, the rugulae conspicuously irregular, being wavy to vermiculate and with a strong granular or punctulate ground-sculpture which may become the dominant component in places . . . . . 23
- 23 Peduncle of petiole ventrally with an elongate convex keel-like process (Fig. 28). Slightly larger species, HW 1.54–1.70, SL 1.44–1.54. (Botswana, South West Africa) . . . . . *flaviventris* (p. 268)
- Peduncle of petiole ventrally without a keel-like process. Slightly smaller species, HW 1.40–1.56, SL 1.38–1.44. (South West Africa) . . . . . *micans* (p. 272)

### Treatment by species

The members of the genus *Ocymyrmex* are very uniform in structure and are not easily divisible into meaningful species-groups. For this reason they are set out below in alphabetical order.

To some extent the genus can be split into three unequal complexes of species based on the degree of constriction of the first gastral tergite. *O. barbiger*, *cavatodorsatus* and *turneri* have the base of the gaster unconstricted, quite broad basally and continuing to broaden behind. In *velox*, *picardi*, *ankhu* and *zekhem* the gaster is narrow basally and gradually broadens behind without forming a narrow neck. In all other species a conspicuous narrow neck, often parallel-sided, is developed. *O. sphinx* forms an intermediate stage between these last two complexes.

The presence or absence of a median clypeal impression seems at first sight a means of dividing the genus into groups but, although a useful key character, it does not serve to aggregate related species. Examination of species without the clypeal impression shows that in most cases they are more closely related to forms possessing it than to the others which lack it.

*Ocymyrmex ankhu* sp. n.

HOLOTYPE WORKER. TL 10·2, HL 2·34, HW 2·35, CI 100, SL 2·30, SI 98, PW 1·50, AL 2·96.

Anterior clypeal margin entire, without a strong median notch flanked by a pair of teeth but only with a tiny erosion of the apron where the weak median clypeal carina runs into it. Maximum diameter of eye 0·42, about 0·18 × HW, the eyes conspicuously failing to break the outline of the sides of the head in full-face view. Sides of head extremely weakly divergent anteriorly, rounding broadly and evenly into the occipital margin which is shallowly convex on each side of a median indentation. Alitrunk in profile with the promesonotum low and very shallowly convex, almost flat dorsally but with the posterior half of the mesonotum sloping more steeply downwards. Propodeal dorsum almost flat, with an exceedingly shallow depression in the surface just in front of the level of the spiracle. Posteriorly the propodeal dorsum rounding broadly and evenly into the shallowly convex declivity. Metapleural lobes low and truncated posteriorly. Petiole in profile large, broadly dome-like and rounded, the anterior peduncle without trace of a ventral process. In dorsal view the petiole node very slightly longer than broad, rounded and with evenly convex sides. Postpetiole in dorsal view broader than long. Base of first gastral tergite no broader than the postpetiole but not constricted to a narrow neck; instead the sides diverge quickly and evenly from the base. Dorsum of head between eyes with faint superficial vestiges of fine and quite dense rugular or costulate sculpture which in places is almost effaced. Ground sculpture absent except for the faintest remnants of a minute superficial reticulation, the surface mostly smooth and glossy and the scattered hair pits quite clearly visible. Occipital region of head mostly smooth but a narrow strip in front of this with feeble transverse sculpture. Pronotal dorsum mostly smooth, with marginal remnants of fine arched rugulae and vestiges of the longitudinally sculptured area between the mesothoracic spiracles just visible. Remainder of dorsal alitrunk very finely and feebly transversely rugulose, with a tendency for the rugulae to fade out centrally. Sides of alitrunk more strongly and more sharply rugulose or costulate, weaker on the pronotal sides than elsewhere. Petiole, postpetiole and gaster unsculptured except for a fine superficial reticulation. Dorsal surfaces of head, alitrunk, petiole and postpetiole with numerous strong reddish brown hairs. Basal half of first gastral tergite hairless but more apically the segment with 1–2 very short, inconspicuous hairs. Colour a uniform rich orange-brown, the gaster very slightly lighter in shade than the head and alitrunk.

PARATYPE WORKERS. TL 9·7–10·2, HL 2·26–2·34, HW 2·22–2·34, CI 97–101, SL 2·22–2·34, SI 95–102, PW 1·40–1·48, AL 2·84–2·92 (7 measured). Maximum diameter of eye 0·42–0·44, about 0·18–0·19 × HW. As holotype.

Holotype worker, **Angola**: 5 miles [8 km] E. of Vila Arriaga, 1000 m, 21.v.1958 (*E. S. Ross & R. E. Leech*) (CAS, San Francisco).

Paratypes. 7 workers and 1 female with same data as holotype (CAS, San Francisco; BMNH; MCZ, Cambridge).

*O. ankhu* is closest related to *velox* and shares most of its diagnostic characters. However, *ankhu* is more or less uniformly coloured and has the body pilosity reddish brown. In *velox* the body is conspicuously tricoloured and the hairs are usually white.

*Ocymyrmex barbiger* Emery

*Ocymyrmex barbiger* Emery, 1886: 364, pl. 17 figs 9–11. Syntype workers and male, SOUTH AFRICA: Cape of Good Hope (*L. Peringuey*) (MHN, Geneva; MCSN, Genoa) [examined].

*Ocymyrmex barbatus* Emery, 1892: 114, 117. [Lapsus for *barbiger* Emery.]

*Ocymyrmex barbiger* var. *robustior* Stitz, 1923: 146. Syntype worker, SOUTH WEST AFRICA: Lüderitzbucht, 5–13.vii.1911; and Swakopmund, 12–19.iv.1911 (*W. Michaelsen*) (MNHU, Berlin) [examined] **Syn. n.**

*Ocymyrmex barbiger* var. *flavescens* Stitz, 1923: 147. Syntype worker, SOUTH WEST AFRICA: Okaputa, 5.v.1911 (*W. Michaelsen*) (MNHU, Berlin) [examined]. **Syn. n.**

WORKER. TL 6·7–7·2, HL 1·54–1·84, HW 1·42–1·76, CI 90–97, SL 1·38–1·58, SI 87–98, PW 0·94–1·10, AL 2·00–2·20 (20 measured).

Anterior clypeal margin with a semicircular median impression which is flanked by a pair of teeth. The impression is usually deep and conspicuous but in some individuals may be broad and quite shallow. The flanking teeth are generally well developed but commonly are broadly triangular and blunted, sometimes little more than broadly rounded prominences. Maximum diameter of eye 0·32–0·35, about 0·19–0·22 × HW, in full face view not breaking the outline of the sides of the head. Promesonotum forming an evenly rounded low convexity which slopes downwards behind to the propodeum, the dorsum of which varies from more or less flat to slightly inclined. Propodeal dorsum rounding broadly and evenly into the

declivity. Metapleural lobes low but prominent, their free edges rounded to bluntly truncated posteriorly. Petiole node in profile usually quite high, bluntly rounded-subconical in shape, but sometimes the dorsum more flattened and the node appearing less regular in shape. Petiole node in dorsal view usually broader than long, less commonly only about as broad as long. Postpetiole always broader than long in dorsal view, discounting the anterior articulating portion. Base of first gastral tergite without a neck-like constriction. Head finely and densely rugulose, with fine punctulate ground-sculpture; the pattern formed by the rugulae very variable on the dorsum but apparently following a step by step change. In many the cephalic rugulae are regular and longitudinal, parallel on the central strip and running straight back to the occipital margin, but the more lateral rugulae tending to diverge and arch outwards behind the eyes. This seems the basic pattern from which the following derive sequentially. Firstly, the median-line rugulae begin to diverge posteriorly, forcing the more lateral rugulae to arch outwards even more. Next, the point at which the median-line rugulae begin to diverge shifts gradually forward, arching the lateral components more strongly outwards all the time. When the point of divergence of the mid-line rugulae has shifted a certain distance forwards a number of V-shaped rugulae appear in front of the impression in the centre of the occipital margin, which occupy the space vacated by the now divergent mid-line rugulae. Then, as the point of divergence of the mid-line rugulae shifts still further forward the V-shaped rugulae also shift forward on the head and their angle becomes more obtuse the further forward they shift. This process continues until ultimately the head is mostly transversely sculptured behind the eyes, although the rugulae tend to retain their broadly V-shaped nature more posteriorly on the head. Pronotal dorsum usually with extensive longitudinal sculpture, the more lateral components arching across in front of the central longitudinals. Space between mesothoracic spiracles usually longitudinally rugose, sometimes obliquely so and very rarely the sculpture here more or less transverse. Remainder of dorsal alitrunk transversely rugose. Petiole with transverse rugulae ventrally which usually extend for some distance up the sides of the node, commonly to the dorsum. In more strongly sculptured samples the rugulae continue across the top of the node but often the dorsum is more weakly sculptured. Postpetiole finely shagreened or with fine superficial patterning only. All dorsal surfaces of head and body with hairs, those on the first gastral tergite more numerous and longer in *barbiger* than is usual in the genus, the gastral hairs frequently approaching the length and density seen on the alitrunk. Elsewhere in the genus gastral hairs on the first tergite are much shorter and much sparser than on the alitrunk. Colour of head and alitrunk orange to dull brick red, the gaster darker, frequently dull brown with a reddish tint or even blackish brown.

One of three known species in which the base of the first gastral tergite is not constricted to a narrow neck, *barbiger* is separable from both others showing this character (*cavatodorsatus*, *turneri*) by its possession of an impressed anterior clypeal margin and its strong sculpture.

#### MATERIAL EXAMINED

**South West Africa:** Maltahoe dist., Sesriem Farm (*M. C. Day*). **South Africa:** Cape Prov., Orange Riv., Kakamas (*G. Arnold*); C.P., Orange Riv., no loc. (*G. Arnold*); C.P., Betty's Bay (*G. Arnold*); C.P., Willowmore (*G. Arnold*); Willowmore (ex coll. Mayr); Willowmore (*H. Brauns*); C.P., Table Mt (*G. Arnold*); C.P., Victoria West (*G. Arnold*); C.P., Mossel Bay (*R. E. Turner*); C.P., Camps Bay (*R. E. Turner*); C.P., Die Panne (*M. C. Day*); C.P., Pt Elizabeth (*W. L. Brown*); C.P., Grahamstown (*L. Weatherill & W. L. Brown*).

#### *Ocymyrmex cavatodorsatus* Prins

*Ocymyrmex cavatodorsatus* Prins, 1965: 1021 figs 1, 2. Syntype workers, SOUTH AFRICA: Cape Prov., Dist. Upington, Louisvale, 6.viii.1964, A.C.Ax 3412 (*A. J. Prins*) (Res. Inst. for Plant Protection, Pretoria, South Africa).

I have not seen the types of this species but it is obvious from Prins' original description that *cavatodorsatus* is a very distinctive species. Its main diagnostic characters are as follows.

**WORKER.** TL 4.5, HL 1.02, AL 1.41. Anterior clypeal margin without a semicircular median impression. Eyes not breaking outline of sides of head in full-face view. Alitrunk in profile characteristically shaped, with the promesonotum forming a single high, strongly arched convexity, the posterior mesonotum and anterior propodeum forming a uniform deep concavity and the remainder of the propodeum arching upwards again posteriorly before rounding narrowly into the deep and almost vertical declivity; the entire alitrunk having a strong saddle-shaped appearance in profile. Petiole node high-subconical in profile, longer than broad in dorsal view. Postpetiole broader than long in dorsal view. Base of first gastral tergite in dorsal view without a neck-like constriction, the sides of the tergite evenly convex behind the point of articulation with the postpetiole. Dorsum of head from level of eyes to occiput smooth and shining. Promesonotal arch dorsally



smooth and shining, including the area between the mesothoracic spiracles. Remainder of dorsal alitrunk with faint transverse rugae which are almost effaced; the propodeal declivity smooth. Head bright red to yellowish red, the alitrunk yellowish red to brick red, the gaster distinctly darker, piceous.

As Prins points out, this species is related to *barbiger* in its lack of a basal gastral constriction. It is separated from *barbiger* by its lack of a clypeal impression, much reduced sculpture and strongly saddle-shaped alitrunk. In these aspects it seems closely related to *turneri*, another species without a gastral constriction, which also lacks a clypeal impression and has reduced sculpture. However, *turneri* has the alitrunk jet black, the clypeal margin prominent medially, the eyes large and breaking the outline of the sides of the head, the scapes with  $SI > 100$  (apparently  $SI < 100$  in *cavatodorsatus* to judge by Prins' fig. 1.) and has a transverse arched crest on the alitrunk at the promesonotal junction.

### *Ocymyrmex celer* Weber stat. n.

(Fig. 19)

*Ocymyrmex weitzeckeri* subsp. *celer* Weber, 1943: 368. Syntype workers, SUDAN: Torit, N. of Imatong Mts, 6.viii.1939, no. 1462 (*N. A. Weber*) (MCZ, Cambridge) [examined].

WORKER: TL 8.1–8.5, HL 1.98–2.04, HW 1.82–1.88, CI 91–94, SL 1.68–1.73, SI 89–95, PW 1.12–1.16, AL 2.30–2.46 (4 measured).

Anterior clypeal margin with a conspicuous median impression which is flanked on each side by a low broad tooth. Sides of head in front of eyes more or less parallel in full-face view, not obviously diverging anteriorly as is frequent in the genus. Maximum diameter of eye 0.38–0.39, about  $0.21 \times HW$ . Dorsum of pronotum in profile flat to indented, sloping upwards behind to its junction with the mesonotum; the promesonotum not forming a single even convexity. Dorsum of propodeum rounding broadly and evenly into the sloping declivity. Metapleural lobes deep but narrow, rounded and little projecting. Petiole node in profile small, low and rounded, in dorsal view longer than broad. Postpetiole in dorsal view slightly longer than broad. First gastral tergite with a neck-like constriction basally. Dorsum of head finely densely and regularly longitudinally costulate, the costulae low and superficial, weakly developed, parallel and arching outwards behind the eyes. Spaces between the costulae highly polished, without strong granular or punctulate ground-sculpture; the whole head with a slick and glossy appearance. Pronotum with weak to feeble arched-transverse costulate sculpture dorsally, which may be almost effaced centrally, the space between the mesothoracic spiracles with longitudinal or transverse costulate sculpture. Remainder of dorsal alitrunk transversely and more strongly costulate. Sides of alitrunk regularly densely sharply costulate everywhere. Petiole node with transverse rugulae ventrally which may extend for some distance up the sides, and with faint rugulae on the dorsal peduncle, but the dorsum of the node unsculptured or only with the faintest vestiges present. Postpetiole only with superficial patterning. All dorsal surfaces of head and alitrunk with numerous hairs of varying length; first gastral tergite with hairs shorter and much sparser than on alitrunk. Colour glossy dull red, the gaster dark brown.

Along with *nitidulus* this species can be separated from all others in which the clypeus is impressed and the first gastral segment constricted by the slick and glossy appearance of the head. In all others the ground-sculpture on the head consists of quite conspicuous granulation or punctulation, but in *celer* and *nitidulus* this is very reduced or absent, leaving the spaces between costulae smooth or very nearly so, and shining. The two may be distinguished by the shape of the pronotum, which in *nitidulus* is convex and, together with the mesonotum, forms an evenly convex surface. In *celer* the pronotum is flat and an even convexity does not result, compare Figs 18 and 19.

#### MATERIAL EXAMINED

Sudan: Torit (*N. A. Weber*).

### *Ocymyrmex cursor* sp. n.

HOLOTYPE WORKER. TL 9.7, HL 2.08, HW 2.04, CI 98, SL 1.94, SI 95, PW 1.30, AL 2.74.

Anterior clypeal margin with a minute and very shallow inconspicuous indentation in the apron medially, without a conspicuous semicircular impression flanked by a pair of teeth. With the head in full-face view the

occipital margin very shallowly but quite broadly concave. Maximum diameter of eye 0.44, about  $0.22 \times HW$ . Promesonotum in profile evenly rounded, sloping posteriorly. Anterior half of propodeal dorsum very feebly concave but above the spiracle very shallowly convex before rounding broadly and evenly into the declivity. Metapleural lobes prominent and narrowly rounded, easily visible in profile, not concealed by the bulge of the metapleural glands. Peduncle of petiole with a broadly triangular low blunt process on its ventral surface, about half-way between the insertion and the level of the spiracle. Node of petiole in profile low and broadly rounded, with a differentiated dorsal surface which is almost flat. In dorsal view the petiole node as long as broad, the postpetiole broader than long. Base of first gastral tergite constricted, forming a neck in dorsal view. Dorsum of head costulate, predominantly longitudinally so but with a few arching in over the eye. Ground-sculpture a fine superficial granulation or punctulation which is more conspicuous away from the midline of the head. Centre of pronotal dorsum almost smooth, with only vestigial sculpture; in front of this arched-transverse costulae are present and behind it longitudinal costulae run back between the mesothoracic spiracles. Remainder of dorsal alitrunk and propodeal declivity transversely rugose. Sides of alitrunk densely and evenly costulate-rugose, the sculpture regular except around the propodeal spiracle. Petiole ventrally transversely rugose from the level of the process and the peduncle dorsally with a few weak transverse rugae. The node itself more weakly sculptured, mostly with superficial patterning only but the posterior face with a few weak transverse rugulae. Postpetiole only with superficial patterning. Dorsal surfaces of head and alitrunk with numerous hairs of varying length but first gastral tergite only with scattered short hairs. Alitrunk glossy dull red, the head lighter and with an orange tint, the gaster darker, reddish brown.

Holotype worker, **Angola**: Kopeio, vii.1931 (*T. D. A. Cockerell*) (BMNH).

The closest relative of *cursor* is *laticeps*, also from Angola. Differentiation of the two species is discussed under *laticeps*.

### *Ocymyrmex flaviventris* Santschi stat. n.

(Fig. 28)

*Ocymyrmex hirsutus* var. *flaviventris* Santschi, 1913: 431. Holotype worker, SOUTH WEST AFRICA: Windhoek (*Viehmeyer*) (NM, Basle) [examined].

WORKER. TL 7.1–7.4, HL 1.64–1.80, HW 1.54–1.70, CI 93–97, SL 1.44–1.58, SI 90–96, PW 0.98–1.04, AL 2.04–2.28 (17 measured).

Anterior clypeal margin with a narrow but deep semicircular impression medially, the impression flanked by a pair of teeth. Occipital corners broadly rounded, the margin medially with a small indentation. Eyes with maximum diameter 0.38, about  $0.22 \times HW$ . Promesonotum in profile evenly shallowly convex, the propodeal dorsum posteriorly rounding narrowly into the declivity which is almost vertical. Metapleural glands swollen and projecting strongly to the rear, in profile concealing all but the extreme tips of the metapleural lobes; the projection of the metapleural glands enhanced by the near-vertical propodeal declivity. Peduncle of petiole ventrally with an elongate keel-like process which is semitranslucent and unsculptured, evenly shallow convex throughout its length. Petiole node small in profile, evenly rounded. In dorsal view the petiole node broader than long, the maximum width of the node about equal to the distance from the spiracle to the apex of the collar where the petiole articulates with the postpetiole. Postpetiole in dorsal view slightly longer than broad. Base of first gastral tergite constricted and forming a neck. Dorsum of head longitudinally very densely finely rugulose, the rugulae close-packed and irregular, being narrowly wavy or even minutely vermiculate in places. Ground-sculpture a conspicuous granulation or punctulation. Rugulae between and on median strip just behind the frontal lobes more regular than elsewhere. Dorsal alitrunk transversely densely rugose, the sculpture longitudinal only between the mesothoracic spiracles and on the arched portion of the pronotum. Sides of alitrunk rugose everywhere. Petiole with a few transverse rugae beneath the node and on the dorsum of the peduncle. Elsewhere on the petiole sculpture is vestigial to absent. Postpetiole unsculptured except for faint superficial patterning. All dorsal surfaces of head and alitrunk with numerous hairs of varying length. Propodeal dorsum with long hairs arising from a fairly dense mat of much shorter hairs. First gastral tergite with sparse scattered hairs which are much shorter than those on the alitrunk. Colour bright orange-yellow, the gaster lighter and more yellow than the head and alitrunk.

*O. flaviventris* is characterized by its light orange-yellow colour, keel-like process below the petiole peduncle, broad node, prominent metapleural glands and uneven cephalic sculpture. It is

closest related to *shushan* and *hirsutus*, but in the former the promesonotum forms a conspicuous high dome and the latter lacks a keel-like subpeduncular process as well as having the cephalic sculpture transverse behind the level of the eyes.

## MATERIAL EXAMINED

**Botswana:** Damara Pan (*G. U. Son*); nr Nkata (*G. U. Son*).

*Ocymyrmex foreli* Arnold stat. n.

*Ocymyrmex weitzaeckeri* [sic] var. *foreli* Arnold, 1916: 197. Syntype workers, ZIMBABWE: Redbank, 7.iv.1912 (*G. Arnold*) (BMNH; NM, Bulaway) [examined].

WORKER. TL 7.3–8.0, HL 1.76–1.86, HW 1.64–1.76, CI 92–95, SL 1.56–1.72, SI 92–98, PW 1.08–1.14, AL 2.28–2.44 (14 measured).

Anterior clypeal margin with a semicircular impression but this impression frequently shallower and broader than is usual in the genus; flanked by a pair of low broad tubercles or blunt small teeth formed by a thickening of the clypeal apron. Maximum diameter of eye 0.34–0.36, about 0.20–0.22 × HW. Promesonotum in profile evenly shallowly rounded and convex. Propodeal dorsum more or less flat to slightly convex, rounding broadly and evenly into the declivity. Metapleural lobes small and rounded. Petiole node in profile large, almost or quite as massively developed as in *sobek*, Fig. 20. In dorsal view the petiole node appearing swollen, as broad as or broader than long; postpetiole dorsally as broad as long, discounting the anterior articulatory section. Base of first gastral tergite constricted and forming a neck behind the postpetiole. Dorsum of head finely and densely longitudinally regularly costulate-rugulose, the components sharply defined and parallel. On the central part of the dorsum the sculpture is longitudinal, running straight back to the occiput or at most diverging slightly on each side of the occipital impression. More laterally on the dorsum the rugulae are divergent and arch outwards behind the eye. Ground-sculpture of head finely punctulate or granular. Pronotal dorsum usually with arched-transverse costulate sculpture followed by a patch of longitudinal sculpture which runs back between the mesothoracic spiracles. However, in some workers the sculpture here is oblique and in a few is more or less transverse. Remainder of dorsal alitrunk and also propodeal declivity transversely costulate or rugose. Petiole node coarsely sculptured everywhere, with strong, sharply defined rugae which encircle the node, running continuously across the dorsal and ventral surfaces and down the sides. Peduncle of petiole also with transverse rugulae both dorsally and ventrally, but these are weaker or effaced on the sides. All dorsal surfaces of head and alitrunk with numerous hairs; first gastral tergite also with hairs but these are shorter and much sparser than those on the alitrunk. Colour usually uniform orange-red to red throughout, but sometimes the gaster slightly lighter or darker than the alitrunk.

This species, known at present only from Zimbabwe, is closest related to *sobek* with which it shares the character of possessing a massively developed petiole node which is coarsely sculptured. The two are separable on colour pattern as in *sobek* the alitrunk is dark reddish brown to almost black, the gaster yellow and contrasting strongly with the alitrunk. The head is dull red, intermediate in colour between alitrunk and gaster. Beside this, the sculpture on the petiole is more sharply defined and regular in *foreli* than in *sobek*.

## MATERIAL EXAMINED

**Zimbabwe:** Bembesi Riv. (*G. Arnold*).

*Ocymyrmex fortior* Santschi stat. n.

(Fig. 26)

*Ocymyrmex weitzeckeri* st. *fortior* Santschi, 1911: 209. Syntype workers, ANGOLA: Benguela, Cucala (*J. Cruchet*) (NM, Basle) [examined].

*Ocymyrmex weitzeckeri* st. *transversus* Santschi, 1911: 209. Holotype female [not worker], ANGOLA: Benguela, Cucala (*J. Cruchet*) (NM, Basle) [examined]. **Syn. n.** [Types of *fortior* and *transversus* originate in a single series.]

*Ocymyrmex arnoldi* Forel, 1913b: 138. Syntype workers, males, ZIMBABWE: Bulawayo (*G. Arnold*) (MHN, Geneva) [examined]. **Syn. n.**

*Ocymyrmex weitzeckeri* [sic] st. *abdominalis* Santschi, 1914a: 16. Syntype workers, SOUTH AFRICA: Natal, Zululand, Entendweni, 20.viii.1905 (*I. Trägårdh*) (NM, Basle) [examined]. [Synonymized with *arnoldi* by Arnold, 1916: 197.]

*Ocymyrmex weitzaeckeri* [sic] var. *usakosensis* Stitz, 1923: 146. Syntype workers, SOUTH WEST AFRICA: Usakos, iv-vi.1911 (*W. Michaelsen*) (syntypes presumed lost, not in MNHU, Berlin). **Syn. n.**

WORKER. TL 6.7-8.2, HL 1.68-2.00, HW 1.58-1.98, CI 94-99, SL 1.40-1.70, SI 85-91, PW 1.04-1.22, AL 2.04-2.44 (20 measured).

Anterior clypeal margin with a semicircular median impression which is flanked on each side by a small tooth or denticle. Maximum diameter of eye 0.36-0.40, about 0.20-0.23 × HW. Promesonotal dorsum evenly shallowly convex in profile, the convex portion not strongly raised above the level of the propodeum so that the slope of the posterior half of the mesonotum is very shallow indeed. Propodeal dorsum flat or slightly sloping, rounding evenly into the declivity, the slope of which is quite steep but by no means vertical. Metapleural lobes low and bluntly rounded, sometimes mostly concealed by the bulge of the metapleural glands but usually easily visible. Peduncle of petiole commonly without a ventral process but quite frequently a low rounded bulge is present, which in a few may be shorter and more prominent, forming a broad, low and rounded angle. Petiole node small and low in profile, evenly rounded, the transition from dorsal surface of peduncle to anterior face of node involving a marked change of slope. Petiole node in dorsal view slender, small, varying from longer than broad to slightly broader than long, but the maximum width of the node usually less than the length from the petiolar spiracle to the apex of the collar where petiole and postpetiole articulate. Postpetiole in dorsal view longer than broad, sometimes only slightly so, but usually the difference easily visible. Base of first gastral tergite strongly constricted and forming a narrow neck behind the postpetiole. Dorsum of head finely, densely and usually very regularly sharply longitudinally costulate, the costulae usually parallel or nearly so over most or all of the area. In many samples all costulae run straight back on the head, but commonly the outermost components tend to curve outwards behind the eyes. Very rarely there is a tendency for the costulae to converge on the midline posteriorly, in which case a few transverse members may be developed on the occipital surface. Ground-sculpture of fine punctulation is present everywhere. Dorsal alitrunk densely costulate or rugose, the usual pattern being with arched transverse sculpture on the anterior part of the pronotum followed by an area of longitudinal sculpture which runs back just beyond the mesothoracic spiracles, followed by coarser transverse sculpture on the remainder of the alitrunk dorsum. Exceptions to this are usually due to the extension of the longitudinal component on the pronotum at the expense of the transverse. At its most extreme the longitudinal component reaches forward almost to the cervical shield, and the other costulae are arched so steeply around it that they appear longitudinal everywhere except on the extreme anterior part. Very rarely the longitudinal costulae may extend back to the mesonotal-propodeal junction. In a few cases the costulae between the mesothoracic spiracles are oblique, and now and then an individual is found in which the entire dorsal alitrunk is transversely sculptured. Ventral surface of petiole with transverse rugulae of variable intensity, usually fairly distinct but grading through to very faint. These rugulae may extend for some distance up the sides of the node before fading out, but rarely reach the dorsum. Dorsum of peduncle and anterior and posterior faces of node usually with weak transverse rugulae, very faint and scratch-like in places; the dorsum of the node itself only rarely with vestiges of rugular sculpture, generally unsculptured or with a superficial patterning. Postpetiole only with a superficial patterning or more or less smooth. All dorsal surfaces of head and alitrunk with hairs of varying length, the hairs of the first gastral tergite much shorter and sparser than on the alitrunk. Head and alitrunk varying from dull brick-red to lighter red, the two always the same colour; gaster darker, blackish brown to black.

*O. fortior* is one of the more widely distributed and commoner species of the genus, ranging widely from Angola to Zimbabwe and South Africa. Among the species with a strongly constricted base to the gaster and a developed clypeal impression *fortior* is defined more by its lack of specialized characters than the possession of them, as can be seen in the key. The closest related species appear to be *phraxus* and *micans*. The former has a differently shaped petiole than *fortior*, which is evenly rugulose dorsally on the node as opposed to the feebly or unsculptured surface seen in *fortior*; *phraxus* is also darker in colour, appearing black with a red head to the naked eye. *O. micans* has different cephalic structure from *fortior* and is also orange to orange-red in colour, with a lighter yellowish gaster.

#### MATERIAL EXAMINED

**Zambia:** Mwingwa (*H. Dollman*). **Zimbabwe:** Bulawayo (*G. Arnold*); Khami Riv. (*G. Arnold*); Lonely Mines (*H. Swale*); R. Zambesi (*H. Swale*); Victoria Falls (*M. Grabham*); Victoria Falls (*W. L. Brown*); Bindurg (*G. H. Bunzli*). **Botswana:** R. Semowane (*M. C. Day*); between Kastwe and Damara Pan (*H. Lang*). **South Africa:** Transvaal, Barberton (*F. S. Parsons*); Transvaal, Saltpan (*H. Lang*); Transvaal, Lydenburg (*H. Lang*); Natal (*G. Arnold*).

*Ocymyrmex hirsutus* Forel

*Ocymyrmex weitzckeri* subsp. *hirsutus* Forel, 1910b: 13. Syntype workers, SOUTH WEST AFRICA: Severelela and Kooa (*L. Schultzze*) (MHN, Geneva) [examined].

*Ocymyrmex hirsutus* Forel; Santschi, 1913: 431. [Raised to species.]

WORKER. TL 6.9–7.8, HL 1.54–1.82, HW 1.48–1.74, CI 93–97, SL 1.40–1.62, SI 90–95, PW 0.96–1.14, AL 2.04–2.36 (7 measured).

Anterior clypeal margin with a conspicuous semicircular median impression which is flanked by a pair of teeth or denticles. Occipital margin in full-face view slightly indented or flattened to feebly concave medially, not evenly transversely convex. Maximum diameter of eye 0.32–0.38, about 0.21–0.23 × HW. Alitrunk in profile with promesonotum evenly convex, sloping behind to the propodeum. Dorsum of propodeum sloping very weakly, rounding broadly and evenly into the declivity. Metapleural lobes short and bluntly triangular. Petiole in profile with a small, low, evenly rounded node, the peduncle without a ventral process but broadly and very shallowly sinuate in some workers. Petiole node in dorsal view varying from as broad as long to distinctly broader than long. Postpetiole dorsally longer than broad. Base of first gastral tergite constricted and forming a narrow neck behind the postpetiole. Rugulose sculpture on dorsum of head fine, irregular and very densely packed, with fine punctulate to granular ground-sculpture between the narrow rugulae. To the level of the posterior margins of the eyes the rugulae are mostly or entirely longitudinal to arched-longitudinal, the pattern varying from specimen to specimen. Behind this level the rugulae are transverse or arched-transverse, tightly packed and narrowly vermiculate. In some the rugulae are so fine and close together, and so narrowly vermiculate, that the occipital sculpture appears as a disorganised mass of narrow irregular wiggly transverse lines. Dorsal alitrunk and declivity of propodeum transversely rugose except between the mesothoracic spiracles where the sculpture is longitudinal. Extent of this longitudinally sculptured area variable, the further forward the rugae extend the more strongly arched is the transverse sculpture of the pronotum. In some the pronotal dorsum is mostly arched-longitudinally rugose. Sides of alitrunk rugose, the sides of the pronotum finer and less densely so than the pleurae. Petiole with a few transverse rugae ventrally and the peduncle also with a few dorsally, but otherwise the segment only superficially sculptured. Postpetiole unsculptured. All dorsal surfaces of head and body except first gastral tergite densely clothed in acute hairs of varying length, very numerous on the dorsal alitrunk. On the sides of the pronotum the hairs are directed forwards; on the pleurae they point backwards and downwards. First gastral tergite with sparse short hairs on the surface and with a denser transverse apical row. Colour reddish, the gaster the same colour as the alitrunk or lighter.

Apart from its dense pilosity *hirsutus* can quickly be recognized by the distinctive sculpture of the head, described above. Transverse sculpture on the area of the head behind the eyes is also found in *robecchii* and in females of the various species of *Ocymyrmex*, but in all of these the sculpture consists of regular transverse costulae, not narrowly vermiculate rugulae.

*Ocymyrmex laticeps* Forel

(Fig. 29)

*Ocymyrmex laticeps* Forel, 1901: 306. Syntype workers, ANGOLA: Mossamedes, Cubango-Cuito (*H. H. Braun & Van der Kellen*) (MHN, Geneva) [examined].

WORKER. TL 7.2–7.6, HL 1.66–1.70, HW 1.70–1.74, CI 102–103, SL 1.56, SI 90–92, PW 1.08–1.14, AL 2.20–2.24 (2 measured).

Middle of anterior clypeal margin flat to very feebly concave, without a semicircular notch or impression. With head in full-face view the occipital margin with only the shallowest of faint indentations medially. Maximum diameter of eye 0.36–0.38, about 0.21–0.22 × HW. Alitrunk in profile with promesonotum evenly shallowly convex, the posterior part of the mesonotum very shallowly concave and sloping down to the propodeum, the anterior half of which is itself slightly sloping; behind this the propodeum levels out before rounding broadly and evenly into the declivity. Metapleural lobes vestigial, merely a thin laminar strip on each side of the petiolar articulation, their width distinctly much less than (about half of) the width of the propodeal spiracle. Petiole in profile as in Fig. 29, the anterior peduncle with a broad low triangular process about half way along its ventral surface. Petiole node in dorsal view narrow, its maximum width c. 0.35, less than the distance from the spiracle to the posterior collar of the petiole. Postpetiole in profile swollen, low in front then forming an evenly convex low dome; the sternite strongly developed and bulging. In dorsal view the postpetiole much longer than broad, gradually increasing in width from front to back.

First gastral tergite strongly constricted basally, forming a narrow neck behind the postpetiole. Dorsum of head with longitudinal fine dense rugulae which become less regular and more disorganized away from the midline and which tend to arch outwards posteriorly, towards the occipital corners, where they become fainter. Spaces between the rugulae with punctulate ground-sculpture except in the median strip behind the frontal lobes. Genae and sides of head below eyes regularly costulate, the costulae fine and dense, sharply defined and fading out on the occipital corners. Sides of alitrunk costulate to rugose, the sculpture finer on the sides of the pronotum, coarser elsewhere, regular except for an area in front of the propodeal spiracle where some wavy rugae are present. Petiole and postpetiole unsculptured except for a vestigial superficial patterning; the petiole ventrally with vestiges of a few transverse rugulae which are faint or incomplete. Dorsal alitrunk transversely or arched-transversely rugulose except between the mesothoracic spiracles where longitudinal sculpture is present. Convex portion of promesonotum less strongly sculptured than remainder of dorsal alitrunk. All dorsal surfaces of head and body with sparse hairs which are apparently absent from the first gastral tergite, but the specimens available have been much abraded so this is not certain. Colour red, the alitrunk darker than the head and pedicel segments where the cuticle has an orange tint. Base of gaster yellowish orange, much darker posteriorly.

This species, known only from the type-series, is closest related to *cursor*, which is also from Angola. They differ as follows

<i>laticeps</i>	<i>cursor</i>
Smaller species, HW 1.70–1.74, SL 1.56, PW 1.08–1.14.	Larger species, HW 2.04, SL 1.94, PW 1.30.
Head slightly broader than long, CI 102–103.	Head slightly longer than broad, CI 98.
Metapleural lobes vestigial, scarcely or not visible in absolute profile.	Metapleural lobes large, conspicuous in absolute profile.
Anterior half of propodeal dorsum sloping downwards, posterior half more or less level.	Anterior half of propodeal dorsum shallowly concave, posterior half rising and shallowly convex.
Petiole node in profile with a short, narrowly rounded dorsum.	Petiole node in profile with an elongate, almost flat dorsum.
Postpetiole longer than broad in dorsal view.	Postpetiole broader than long in dorsal view.

Sculpture in the two species is very similar and they also share the characters of lacking a semicircular clypeal impression and possessing a broad ventral process on the peduncle of the petiole. Five other known species do not have a semicircular impression in the middle of the anterior clypeal margin, *cavatodorsatus*, *velox*, *ankhu*, *zekhem* and *turneri*, but none of these has the strongly developed constriction of the first gastral tergite seen in *laticeps* and *cursor*, and all lack a subpetiolar process. Apart from this *turneri* is small (HW < 1.30) and has large eyes which break the outline of the sides in full-face view; *velox* has a high, strongly convex petiole node (Fig. 32) and very feeble cephalic sculpture; and *cavatodorsatus* has the alitrunk strongly saddle-shaped in profile and the posterior half of the cephalic dorsum unsculptured.

### *Ocymyrmex micans* Forel stat. n.

*Ocymyrmex weitzeckeri* var. *micans* Forel, 1910b: 12. Holotype worker, SOUTH WEST AFRICA: Okahandja (Peters) (MHN, Geneva) [examined].

WORKER. TL 6.2–6.9, HL 1.54–1.70, HW 1.40–1.56, CI 91–92, SL 1.38–1.44, SI 92–98, PW 0.92–1.00, AL 2.00–2.16 (2 measured).

Anterior clypeal margin with a semicircular median impression which is flanked by a pair of small teeth. Occipital margin very slightly concave or indented medially. Maximum diameter of eye 0.32–0.36, about 0.23 × HW. With alitrunk in profile the promesonotum evenly shallowly convex. Propodeal dorsum rounding broadly and evenly into the declivity. Metapleural lobes small and only feebly projecting, in profile mostly or wholly concealed by the bulge of the metapleural glands. Petiole node well defined, the dorsum narrowly and evenly rounded in profile, dome-like. Postpetiole swollen, the tergite low in front then rising behind into a distinctly convex, smoothly rounded node. In dorsal view the petiole node broad and conspicuous, its maximum width slightly greater than the distance from the spiracle to the apex of the petiolar collar where it articulates with the postpetiole. Postpetiole in dorsal view narrow in front, becoming

much broader behind, the width greater than the length. Base of first gastral tergite strongly constricted and forming a narrow neck behind the postpetiole. Sculpture of dorsum of head of dense, closely packed fine longitudinal irregular rugulae which, away from the midline in the area behind the level of the eyes, curve out towards the occipital corners. Behind the level of the eyes a conspicuous punctulate ground-sculpture is present which in places may be the dominant component of the sculpture. Where this is the case the rugulae are distinctly uneven, becoming wavy or even vermiculate. Dorsal alitrunk and propodeal declivity transversely rugose except between the mesothoracic spiracles where the sculpture is longitudinal. On the pronotum the rugae are arched-transverse around the longitudinal component. Sides of alitrunk regularly rugose, the rugae weakest and most widely spaced on the sides of the pronotum. Petiole and postpetiole unsculptured or the former with a few weak transverse rugulae ventrally and scattered vestigial marks elsewhere. All dorsal surfaces of head and body with numerous hairs of varying length except for the first gastral tergite where the hairs are short and sparse. Colour orange to orange-red, the gaster lighter in shade than the alitrunk.

*O. micans*, known at present only from the Okahandja region of South West Africa, is closest related to the widely distributed *fortior*. The two are separated on cephalic sculpture which is stronger, more sharply defined and more regular in *fortior*, and the punctulate ground-sculpture never dominates the rugulose/costulate component in this species. Besides this, the postpetiole of *fortior* is relatively long and narrow, always longer than broad, whereas in *micans* the postpetiole is distinctly swollen posteriorly and its width exceeds its length. Similarly, the petiole node in dorsal view is always markedly expanded in *micans*, only moderately so in *fortior*.

MATERIAL EXAMINED.

**South West Africa:** Okahandja (*M. C. Day*).

*Ocymyrmex monardi* Santschi **stat. n.**

*Ocymyrmex weitzckeri* st. *monardi* Santschi, 1930: 68. Syntype workers, ANGOLA: Cakindo (*A. Monard*) (NM, Basle) [examined].

WORKER. TL 7.4–8.1, HL 1.78–1.88, HW 1.68–1.86, CI 95–99, SL 1.60–1.72, SI 92–95, PW 1.06–1.24, AL 2.22–2.40 (3 measured).

Anterior clypeal margin medially with a distinct semicircular impression which is flanked on each side by a small tooth. Eyes with maximum diameter 0.37–0.40, about 0.21–0.22 × HW. Promesonotum in profile evenly rounded, sloping posteriorly to the propodeum which itself slopes very shallowly to the evenly rounded posterior angle where the dorsum meets the declivity. Metapleural lobes small, broadly rounded to truncate posteriorly, not triangular. Metapleural glands not strongly swollen nor strongly projecting posteriorly, in profile not concealing even the bases of the metapleural lobes. Petiole in profile with the node evenly rounded, dome-like; in dorsal view the node as broad as long or slightly longer than broad. Postpetiole in dorsal view very slightly longer than broad. Base of first gastral tergite constricted. Sculpture on dorsum of head characteristic; space between frontal lobes and median strip of dorsum behind the frontal lobes finely and densely longitudinally costulate, with feeble punctulate ground-sculpture between the costulae. Behind the level of the eyes the costulae of this median area become much weaker and show signs of diverging, or fade out altogether, being replaced partially or entirely by coarse punctulate or granular sculpture which is very dense and conspicuous. The space between the inner margin of the eye and the antennal fossa, and the area extending back from this level to the occiput covered with dense irregular granular sculpture. Dorsal alitrunk and propodeal declivity transversely rugose except for the space between the mesothoracic spiracles and the median strip of the pronotum in front of this level, where the rugae are longitudinal. Petiole and postpetiole unsculptured except for faint superficial patterning or the former at most with a few vestigial transverse rugulae ventrally. All dorsal surfaces of head and body with hairs, but those on the first gastral tergite shorter and much sparser than on the alitrunk, where strong hairs are conspicuous. Alitrunk dull red to reddish tinted black, the head somewhat lighter in shade.

This moderately sized quite darkly coloured species is closely related to *fortior*, but is separated from it and from other close forms by the distinctive pattern of sculpture on the head.

MATERIAL EXAMINED

**South West Africa:** Swakopmund (*M. C. Day*).



*Ocymyrmex nitidulus* Emery stat. n.

(Figs 18, 22, 23)

*Ocymyrmex robecchii* st. *nitidulus* Emery, 1892: 116. Holotype female [not worker], SOMALI REPUBLIC: Obbia (*Robecchi*) (MCSN, Genoa) [examined].

WORKER. TL 7.4–7.8, HL 1.70–1.90, HW 1.64–1.82, CI 96–100, SL 1.48–1.60, SI 86–96, PW 1.08–1.20, AL 2.20–2.30 (20 measured).

Anterior clypeal margin with a conspicuous median semicircular impression which is flanked on each side by a low tooth or denticle, this tooth usually quite low and rounded, uncommonly strongly prominent. Maximum diameter of eye 0.34–0.40, about 0.20–0.22 × HW. Shape of alitrunk as in Fig. 18, the promesonotum evenly and broadly convex, sloping posteriorly to the propodeal dorsum; the latter rounding evenly into the declivity. Metapleural lobes small and low, bluntly rounded or broadly and bluntly truncated, sometimes reduced to a narrow little-projecting strip. Petiole node in profile small, low and smoothly rounded. In dorsal view the petiole node varying from slightly longer than broad to slightly broader than long. Postpetiole as broad as long to slightly broader than long in dorsal view. First gastral tergite constricted and forming a neck basally. Dorsum of head sculptured with low, rounded, feeble longitudinal costulae which may be very reduced or even effaced in places. Spaces between the costulae without ground-sculpture, the surface smooth and polished, with a slick and glossy appearance. Sides of alitrunk closely and finely sharply constulate, the dorsum sharply transversely costulate except between the mesothoracic spiracles where the sculpture is usually longitudinal. Pronotal dorsum in front of the longitudinal sculpture finely arched-costulate to smooth, the sculpture always weaker than elsewhere on the alitrunk, sometime partially or wholly effaced or the costulae reduced to vestiges. This weakening of the sculptural intensity may also affect the longitudinal costulae between the mesothoracic spiracles. Ventral surface of petiole node with a few transverse rugulae which may be very feeble but which normally extend for some distance up the sides of the node before fading out. Dorsum of petiole node unsculptured or at most with vestiges remaining. Dorsum of peduncle usually with transverse fine rugulae but these may be very reduced and faint. Postpetiole unsculptured or at most with some fine superficial patterning. All dorsal surfaces of head and alitrunk with numerous hairs of varying length, the first gastral tergite with hairs shorter and sparser than elsewhere. Colour glossy dull red, the gaster darker, blackish brown to black; entire body with a polished and shining appearance.

Only *nitidulus* and *celer*, among the species with the clypeus impressed and gaster constricted basally, lack strong ground-sculpture between the costulae or rugulae of the dorsal head. This gives them a slick and very polished appearance which immediately separates them from their allies in which granular or punctulate ground-sculpture is present, and which in consequence are dull and less polished. *O. nitidulus* and *celer* are separated by the shape of the pronotum, which is flat in the latter, rounded in the former (compare Figs 18 and 19), and by the shape of the head which is longer and narrower in *celer* than in *nitidulus*.

## MATERIAL EXAMINED

**Ethiopia:** Meisso (*K. Guichard*). **Kenya:** Kajiado (*G. Nyamasyo*), Kajiado (*J. Darlington*). **Uganda:** N. Turkana Prov. (Lake Rudolf expd.). **Tanzania:** Longido West (*A. Loveridge*).

*Ocymyrmex phraxus* sp. n.

(Fig. 27)

HOLOTYPE WORKER. TL 7.9, HL 1.92, HW 1.82, CI 95, SL 1.58, SI 87, PW 1.15, AL 2.32.

Anterior clypeal margin with a deep median impression which is flanked on each side by a tooth. Sides of head in front of eyes more or less parallel, the head not broadening anteriorly. Maximum diameter of eye 0.38, about 0.21 × HW. Promesonotum forming an even, low convexity in profile which slopes gently downwards posteriorly. Propodeal dorsum rounding evenly into the declivity. Metapleural lobes low and rounded. Petiole in profile with a small node which is not sharply differentiated from the peduncle; the dorsum of the peduncle runs into the anterior face of the node without a marked change in slope. This surface is confluent behind with the dorsum, which is low and broadly evenly rounded. In dorsal view the node is narrow and almost parallel-sided, its maximum width not much greater than that of the posterior peduncle. Postpetiole longer than broad in dorsal view, discounting the anterior articulatory section. First gastral tergite constricted basally, forming a narrow neck behind the postpetiole. Dorsum of head densely sculptured with fine, sharply defined parallel longitudinal rugulae which are slightly divergent posteriorly



and more divergent laterally where they tend to arch outwards behind the eyes. Spaces between the rugulae filled with a fine dense and conspicuous punctulate ground-sculpture. Pronotum with arched-transverse costulae, with a patch of longitudinal sculpture between the mesothoracic spiracles. Remainder of dorsal alitrunk transversely rugose except for a small disorganized patch between the propodeal spiracles. Alitrunk dorsally lacking the punctulate ground-sculpture seen on the head. Petiole with a number of very fine rugulae which encircle the node, the postpetiole only with fine superficial patterning, or light shagreening. Dorsal surfaces of head and alitrunk all with numerous hairs, those on the first gastral tergite much shorter and sparser than those on the alitrunk. Alitrunk a dark, deep red, dully shining. Head dark red but lighter in shade than the alitrunk, the contrast easily visible to the naked eye. Gaster blackish brown to black, darker than the rest of the body.

PARATYPE WORKERS. TL 7.7–8.0, HL 1.90–1.96, HW 1.80–1.86, CI 94–96, SL 1.56–1.60, SI 85–89, PW 1.14–1.16, AL 2.26–2.34 (5 measured). Maximum diameter of eye 0.36–0.38, about 0.20–0.21 × HW. As holotype but some with the petiole node slightly broader in dorsal view and with the disorganized rugular patch on the propodeal dorsum less obviously developed.

Holotype worker, **Tanzania**: Shinyanga, viii.1949 (B. K. Coll.) (BMNH).

Paratypes. 4 workers with the same data as holotype (BMNH; MHN, Geneva).

Non-paratypic material examined. **Tanzania**: no further data.

The non-paratypic series matches the type-series well but has sculpture slightly more intense in development and has some workers which are slightly smaller, HL 1.78–1.90, HW 1.70–1.82, CI 95–96, SL 1.54–1.64, SI 90–93.

The sculpture of the petiole in *phraxus* is reminiscent of a reduced version of that found in *sobek*, but in the latter the node is greatly swollen and very distinctive (Fig. 20), and the gaster is yellowish, much lighter than the alitrunk.

### *Ocymyrmex picardi* Forel

*Ocymyrmex picardi* Forel, 1901: 306. LECTOTYPE worker, ANGOLA: Mossamedes, Cubango-Cuito (MHN, Geneva), here designated [examined].

*Ocymyrmex carpenteri* Donisthorpe, 1933: 195. Holotype female [not worker], BOTSWANA: Ngamiland, ix.1930–i.1931 (*G. D. H. Carpenter*) (BMNH) [examined]. **Syn. n.**

*Note.* The number of specimens in the original syntypic series of *picardi* was not stated by Forel. At the time of this study only two specimens, mounted on a single pin, were found bearing the label 'typus'. Of these the top specimen is a worker and fits the original description perfectly; it is here designated as lectotype of *picardi*. The lower specimen, now remounted on a separate pin, is a female and is not mentioned in the original description.

WORKER. TL 11.6–12.6, HL 2.52–2.80, HW 2.44–2.68, CI 93–97, SL 2.30–2.52, SI 90–98, PW 1.60–1.80, AL 3.40–3.68 (20 measured).

Very large species. Anterior clypeal margin with a conspicuous median semicircular impression which is flanked by a small tooth on each side. Maximum diameter of eye 0.46–0.51, about 0.19–0.20 × HW. With the head in full-face view the occipital margin varying from approximately transverse to feebly indented medially. Promesonotum in profile evenly and broadly convex, sloping posteriorly to the propodeal dorsum which, in this species, is not as strongly depressed below the level of the promesonotum as is usual elsewhere in the genus. Propodeal dorsum rounding broadly and evenly into the declivity. Metapleural lobes rounded, visible in profile, not concealed by the bulge of the metapleural glands. Petiole node in dorsal view as broad as or broader than long. Postpetiole slightly longer than broad in dorsal view, discounting the anterior articulatory portion. Base of first gastral tergite narrow, in dorsal view no broader than the postpetiole, but the sides evenly diverging from their junction with the postpetiole, without a roughly parallel-sided neck. Dorsum of head finely, densely and more or less evenly longitudinally costulate, the costulae rarely approximately straight, much more commonly diverging behind towards the occipital corners. Infrequently a few transverse costulae may be present occipitally. Individual costulae commonly irregular, tending to be narrowly sinuate or wavy, especially away from the midline of the dorsum. Ground-sculpture a fine dense punctulation. Dorsal alitrunk and propodeal declivity transversely rugose except for the space between the mesothoracic spiracles and part of the pronotal dorsum, where sculpture is longitudinal to oblique. Sides of alitrunk rugose, the sculpture less regular on the pleurae than on the sides of the pronotum. Petiole with transverse rugae ventrally, below the node, and also with a few dorsally on the peduncle in front of the node.

On the node itself sculpture is usually restricted to a superficial patterning with vestigial rugulae, but occasionally one or two stronger transverse rugulae may be present dorsally, or vertically on the sides, or both. Postpetiole unsculptured except for superficial patterning. All dorsal surfaces of body with scattered strong dark hairs which are reddish brown to blackish; those on the first gastral tergite very sparse and much shorter than those on the alitrunk. Colour very dark red to black, the head usually slightly lighter in shade than the alitrunk and the gaster generally darker.

A very conspicuous species, the largest known in the genus, *picardi* appears to be quite widely distributed in southern Africa. By its size alone it is unlikely to be confused with any other species.

The female (queen) of *picardi* was first described by Donisthorpe as a worker, under the name of *carpenteri*. The holotype matches the female in the same series as the *picardi* lectotype and the synonymy is thus absolute. The female of *picardi* fits the description given above and its dimensions fall within the ranges given. The only differences from the worker lie in those characters discussed under the generic diagnosis, namely the broader straighter margins to the frontal lobes, broader antennal scapes and sharp transverse sculpture on the posterior portion of the dorsum of the head.

#### MATERIAL EXAMINED

**Zimbabwe:** Umgusa Riv., Sawmills (*G. Arnold*); Insiza Riv. (no name). **Botswana:** Sevrelela (*L. Schultze*); Okavango Delta, Smiti (*A. Russell-Smith*); Kalabura (ex coll. Donisthorpe); Tsabong (*G. Arnold*); Nkate (Vernay-Lang expd.); Matopo Pan (*G. U. Son*); Shaleshonto (*G. U. Son*). **South West Africa:** Kalahari Desert (no name).

### *Ocymyrmex robecchii* Emery

(Fig. 24)

*Ocymyrmex robecchii* Emery, 1892: 114, fig. Syntype workers, SOMALI REPUBLIC: Uebi (*Robecchi*), and Erdal (*Pavesi*) (MHN, Geneva; MCSN, Genoa) [examined].

WORKER. TL 9.2–9.3, HL 2.20–2.22, HW 2.02–2.04, CI 92, SL 2.08–2.16, SI 103–106, PW 1.26–1.28, AL 2.52–2.60 (2 measured).

Anterior clypeal margin with a strong semicircular median impression flanked by a pair of short rounded denticles. Outline shape of head as in Fig. 24, the head longer than broad (CI < 100), with sides which converge posteriorly, and with the occipital margin strongly impressed medially. Maximum diameter of eye 0.40, about 0.20 × HW. Scapes long, SI > 100. With alitrunk in profile the mesonotum anteriorly forming a distinct hump behind the pronotum, the two not forming a single continuous convexity. Orifices of mesothoracic spiracles protected by a pair of low tumuli or welts which project from the surface. Mesonotal dorsum sloping shallowly downwards posteriorly and confluent with the propodeal dorsum which is flat to very feebly concave to the level of the spiracle where it becomes shallowly convex and rounds broadly and evenly into the declivity. Metapleural lobes large and strongly developed, prominent, broadly subtriangular in shape and slightly upcurved. Peduncle of petiole without a ventral process. Petiole node in dorsal view very narrow, slightly expanded. Postpetiole in dorsal view much longer than broad. Basal portion of first gastral tergite constricted, forming a narrow neck behind the postpetiole. Dorsum of head with arched-longitudinal costulae on the genae and frontal lobes, the costulae curving in towards the midline posteriorly. Remainder of dorsum to occipital margin densely transversely costulate. Ground-sculpture vestigial, merely a superficial patterning between the costulae. Sides of alitrunk strongly, regularly and sharply costulate everywhere, the dorsum similarly sculptured, as is the propodeal declivity. All dorsal sculpture transverse except between the mesothoracic spiracles. Petiole encircled by fine rugulae or costulae which are most strongly developed ventrally. Postpetiole and gaster unsculptured. All dorsal surfaces of head and body with scattered acute hairs of varying length; those on the first gastral tergite shorter and sparser than elsewhere. Colour dark dull red, the postpetiole and gaster lighter, yellowish.

A large and conspicuous species, *robecchii* is characterized by its strongly impressed median clypeal notch, transverse cephalic sculpture, strongly impressed occipital margin, long scapes and large size. Although the two specimens seen possess the transverse cephalic sculpture characteristic of females in this genus, they lack the associated characters of shorter thicker scapes and broader, more parallel-sided frontal lobes which are usually associated with this caste (see discussion under the generic diagnosis). For this reason I have chosen to treat these specimens as

bona fide workers for the time being, and have used the direction of cephalic sculpture as a key character in case they do not turn out to be females. This of course cannot be ascertained until more material becomes available.

*Ocymyrmex shushan* sp. n.

(Fig. 31)

HOLOTYPE WORKER. TL 6.7, HL 1.66, HW 1.58, CI 95, SL (antennae missing), PW 1.02, AL 2.14.

Anterior clypeal margin with a small but distinct median semicircular impression, which is flanked by a pair of short, acute teeth. Maximum diameter of eye 0.34, about  $0.22 \times HW$ . Sides of head behind eyes evenly convex and narrowing, rounding into the occipital margin with which, if it were not for the median impression in the latter, they would form a very regular arc. In profile the posterior pronotum and anterior part of mesonotum high and strongly convex, forming a dome-like outline above the level of the mesothoracic spiracles. Pronotum in front of this and mesonotum behind it sloping away evenly, increasing the dome-like appearance. Posterior portion of mesonotum and dorsum of propodeum more or less flat in profile, the latter rounding broadly into the convex declivity. Metapleural lobes small and low, rounded. Peduncle of petiole flat dorsally but sinuate ventrally. Petiole node in profile low dome-like, smoothly and evenly rounded. Postpetiole in profile subglobular, Fig. 31. In dorsal view the petiole node much broader than long, all surfaces smoothly rounded; postpetiole slightly longer than broad. Base of first gastral tergite constricted and forming a neck behind the postpetiole. Dorsum of head finely and densely longitudinally rugulose, the rugulae diverging away from the midline posteriorly. Ground-sculpture between the rugulae a strong and conspicuous punctulation which in places seems as strongly developed as the regular sculpture. Pronotum with a few strong transverse costulae on the cervical shield but behind this the costulae which arch up from the sides become very faint or vestigial when traversing the dorsum. Between the mesothoracic spiracles and extending for a short distance forwards and backwards is a patch of low longitudinal rugosity. Remainder of alitrunk and propodeal declivity transversely rugose or costulate. Petiole node smooth and shining, the anterior peduncle with some very faint transverse striae. Postpetiole unsculptured. Body everywhere lacking the conspicuous punctulate ground-sculpture which is so well developed on the head. All dorsal surfaces of head and body with numerous hairs, those on the first gastral tergite shorter and sparser than those on the alitrunk. Colour uniform bright orange.

Holotype worker, **South West Africa**: Gobasis, 17.xii.1933 (*J. Ogilvie*) (BMNH).

This bright orange species is characterized amongst forms with both a gastral constriction and an impressed clypeal margin by the strongly convex anterior portion of the dorsal alitrunk and the shape of the petiole, as described above.

*Ocymyrmex sobek* sp. n.

(Fig. 20)

HOLOTYPE WORKER. TL 7.8, HL 1.90, HW 1.82, CI 96, SL 1.70, SI 93, PW 1.18, AL 2.44.

Anterior clypeal margin with a conspicuous median semicircular impression which is flanked by a pair of small teeth. Occipital margin in full-face view feebly indented medially, the margin continuous with the sides through a broad, shallow curve. Maximum diameter of eye 0.40, about  $0.22 \times HW$ . Promesonotum in profile evenly convex, the dorsum of the propodeum rounding broadly and evenly into the declivity. Metapleural lobes small, subtriangular in shape, but plainly visible in profile and not concealed by the bulge of the metapleural glands. Ventral surface of peduncle of petiole without a projecting process, the node strongly swollen and conspicuous (Fig. 20). In profile the large node with a developed posterodorsal angle, not rounded as is usual in the genus. In dorsal view the petiole node massive, almost as large as the postpetiole; the latter also somewhat swollen, about as high as long in profile and broader than long in dorsal view. Base of first gastral tergite constricted, in dorsal view forming a neck behind the postpetiole which is narrower than the maximum width of the postpetiole itself. Dorsum of head finely and densely costulate to rugulose, the sculpture most regular on the central strip of the dorsum. On each side of this central strip the rugulae more wavy and irregular, and tending to diverge posteriorly towards the occipital corners, arching round above the eyes. Spaces between the rugulae with fine dense punctulate ground-sculpture. Anterior portion of pronotum with arched-transverse rugae, behind this with an area where the rugae are almost longitudinal, very slightly oblique, running back between the mesothoracic spiracles; remainder of dorsum and also propodeal declivity coarsely transversely rugose. Sides of alitrunk coarsely

rugose. Node of petiole coarsely rugose, the rugae continuous, running transversely on the ventral surface, up the sides of the node and across the dorsum; on the dorsum less regular than elsewhere. Anterior face of node and dorsum of peduncle in front of node also transversely rugose. Postpetiole unsculptured except for fine superficial shagreening. Dorsal surfaces of head, alitrunk and pedicel segments with numerous strong hairs. First gastral tergite with hairs much shorter and sparser than elsewhere. Alitrunk dull reddish black (appearing black to the naked eye); gaster dull yellowish red, much lighter than the alitrunk and contrasting strongly with it; head a dull red intermediate in shade between gaster and alitrunk so that the ant appears tricoloured to the naked eye.

PARATYPE WORKERS. TL 7.6–8.0, HL 1.70–1.90, HW 1.64–1.88, CI 93–100, SL 1.56–1.74, SI 92–99, PW 1.08–1.20, AL 2.20–2.44 (11 measured). Maximum diameter of eye 0.36–0.40, about 0.22–0.24 × HW. Answering description of holotype but some with the posterodorsal angle of the petiole more rounded and the pronotal sculpture showing the usual variation, with differences in extent and direction of the longitudinal component. In most the longitudinal rugae are antero-posteriorly straight, but in some (as in the holotype) they are oblique and in a few decidedly transverse. Sculpture pattern on the dorsum of the head is usually as described above but in a few the rugulae run straight back everywhere, not diverging towards the occipital corners, and in one the rugulae between the eye and the central strip of the head are more or less all transverse.

Holotype worker, **Botswana**: Smiti, no. 16, mopane woodland, 11.ix.1975 (*A. Russell-Smith*) (BMNH).

Paratypes. 11 workers with same data as holotype (BMNH; MCZ, Cambridge; NM, Basle; MHN, Geneva; NM, Bulawayo).

Non-paratypic material examined. **Zimbabwe**: Victoria Falls (*G. Arnold*); Victoria Falls (*H. Swale*); Victoria Falls (*M. Grabham*). **Botswana**: Kabulubula (*G. U. Son*).

Size range in the non-paratypic material is TL 7.6–8.8, HL 1.80–2.00, HW 1.70–1.96, CI 93–98, SL 1.64–1.80, SI 91–98, PW 1.12–1.28, AL 2.24–2.52 (15 measured). Measurements of eyes all fall within the range of the paratype-series.

This strongly sculptured and conspicuously coloured species is closest related to *foreli*. Among the species with a clypeal impression and a distinctly constricted first gastral segment only two, *sobek* and *foreli*, have the petiole much enlarged and very strongly sculptured. The two are best separated on their colour, as indicated in the key, but it is also notable that the rugae on the petiole node are narrower and more sharply defined in *foreli* than in *sobek*, where they tend to be blunted and much less regular on the dorsum.

### *Ocymyrmex sphinx* sp. n.

(Fig. 21)

HOLOTYPE WORKER. TL 9.3, HL 2.18, HW 2.04, CI 94, SL 1.96, SI 96, PW 1.32, AL 2.86.

Large species. Anterior clypeal margin with a conspicuous semicircular impression medially which is flanked on each side by a low but broad triangular tooth. Occipital margin feebly indented medially in full-face view. Maximum diameter of eye 0.43, about 0.21 × HW, the eyes distinctly failing to break the outline of the sides of the head in full-face view. Promesonotum rounded in profile, sloping posteriorly to the propodeum which is almost flat and which rounds evenly into the steep declivity. Metapleural lobes small, narrowly rounded and prominent, in absolute profile just visible behind the bulge of the projecting metapleural glands. Petiole node small and rounded in profile, the peduncle with a feebly convex area midway along its ventral surface but without a developed process. Petiole node in dorsal view distinctly broader than long, strongly developed, constricted behind at the posterior peduncle. Postpetiole about as broad as long in dorsal view, excluding the anterior articular portion. Base of first gastral tergite narrow, no wider than the postpetiole, but not forming as conspicuously narrowed a neck as is usual in this genus. Instead the gaster begins to widen gradually almost immediately behind its articulation with the postpetiole, the sides at first gradually and then more strongly divergent in dorsal view. Dorsum of head finely, densely and irregularly longitudinally rugulose everywhere, with dense conspicuous coarse punctulate to granular ground-sculpture between the rugulae. On the central strip of the dorsum the rugulae are most regular behind the frontal lobes, posteriorly they become narrowly vermiculate. Occipitally and laterally on the dorsum the rugulae are narrowly vermiculate everywhere and tend to arch outwards behind the eyes. Rugae on pronotal dorsum arched-transverse anteriorly. An area of longitudinal sculpture occurs between the mesothoracic spiracles, visible in paratypes, but in the holotype a pin is inserted at this point and the

sculpture destroyed. Remainder of dorsal alitrunk and declivity coarsely transversely rugose. Petiole and its peduncle finely transversely rugose ventrally; behind the level of the spiracle the rugae continuing up the sides of the node and across the dorsum. Transverse rugae also present on dorsum of peduncle. Dorsum of postpetiole finely granular and matt. All dorsal surfaces of head and alitrunk densely clothed with hairs, many of them quite short. Propodeum dorsally also with dense pubescence. Hairs on first gastral tergite very short and sparse. Colour a very dull dark red, the gaster black.

PARATYPE WORKERS. TL 9.5–10.1, HL 2.16–2.28, HW 2.08–2.14, CI 93–96, SL 1.95–2.06, SI 94–98, PW 1.38–1.44, AL 2.90–3.02 (12 measured). Maximum diameter of eye 0.44–0.46, about 0.20–0.22 × HW. As holotype but some showing shorter pilosity than others, apparently due to the hairs having been broken off.

Holotype worker, **Botswana**: 18 miles [29 km] NE. of Kalkfontein, 12–13.iv.1972, no. B3 (*M. C. Day*) (BMNH).

Paratypes. **Botswana**: 19 workers, Kuke Pan, 26.iii.1930, Vernay-Lang Kalahari Expd. (*G. U. Son*) (MCZ, Cambridge; BMNH; NM, Bulawayo).

At first glance this species appears to be a smaller version of *picardi* but, apart from being consistently smaller it has silvery body hairs where those of *picardi* are dark reddish brown to blackish, has much denser pilosity and pubescence on the propodeal dorsum and has much stronger, denser and more sharply defined ground-sculpture on the dorsum of the head than is seen in *picardi*. The cephalic sculpture of *sphinx* is much the same as that seen in *monardi*, but this latter species is much smaller and has the petiole node unsculptured.

### *Ocymyrmex turneri* Donisthorpe

(Fig 25)

*Ocymyrmex turneri* Donisthorpe, 1931: 499. Holotype worker, SOUTH WEST AFRICA: Walvis Bay, 1.xii.1927 (*R. E. Turner*) (BMNH) [examined].

WORKER. TL 5.8, HL 1.40, HW 1.28, CI 91, SL 1.40, SI 109, PW 0.80, AL 1.76.

Small species. Anterior clypeal margin without a median impression, on the contrary the middle of the anterior clypeal margin projecting forward as a low, broad triangular prominence. Eyes relatively large, maximum diameter 0.36, about 0.28 × HW. In full-face view the eyes very conspicuously breaking the outline of the sides of the head. Antennal scapes relatively long, SI > 100. Promesonotum in profile rounded, with a low transversely arched crest running across the dorsum at the junction of pronotum and mesonotum, arching forward from the mesothoracic spiracle on each side. Posterior part of mesonotum and anterior part of propodeum concave in profile, the posterior portion of the propodeum convex and curving evenly into the declivity behind. Petiole node in profile high, subconical, with a narrowly rounded dorsum, the posterior face convex, the anterior face longer, almost flat and less steeply sloped than the posterior face. Petiole node in dorsal view longer than broad, the postpetiole broader than long. First gastral tergite without a constricted basal neck. Dorsum of head glossy, sculptured with very feeble superficial rugulae which are transversely arched and are almost effaced occipitally. Ground-sculpture between the faint rugulae absent. Dorsal alitrunk unsculptured, smooth and highly polished except for vestiges of faint transverse rugulae on the extreme anterior portion of the pronotum and the propodeal declivity. On the sides of the alitrunk the pleurae with strong, widely spaced and roughly parallel rugae, otherwise unsculptured except for vestiges on the sides of the pronotum near the base. Petiole and postpetiole only with faint superficial patterning which is almost effaced in places. All dorsal surfaces of head and body with scattered hairs of varying length but the holotype (and only known specimen) appears to be considerably abraded and in life this species may well be as hairy as other species in the genus. Alitrunk jet black and shiny, head and gaster blackish brown.

*O. turneri* is one of the smallest species known in the genus and is easily distinguished from all others by having an unconstricted base to the gaster, large eyes which break the outline of the sides of the head, reduced sculpture, relatively long antennal scapes and a clypeal margin which projects medially into a low triangular prominence. To date it remains known only from the holotype.

*Ocymyrmex velox* Santschi

(Fig. 32)

*Ocymyrmex velox* Santschi, 1932: 387. Syntype workers, SOUTH WEST AFRICA: Otjimbimbi, Kunene R., iii.1923 (*G. Arnold*) (NM, Basle; NM, Bulawayo) [examined].

WORKER. TL 10.0–10.7, HL 2.20–2.40, HW 2.08–2.30, CI 95–97, SL 2.10–2.29, SI 101–105, PW 1.30–1.42, AL 2.48–2.96 (8 measured).

Large species; anterior clypeal margin entire or very feebly eroded medially giving a weakly crenellated appearance, without a median semicircular impression. Maximum diameter of eyes 0.40–0.43, about 0.19–0.20 × HW. Frontal lobes distinctly convergent posteriorly, the occipital margin indented medially in full-face view. Antennal scapes relatively long, SI above. Promesonotum forming an even low convexity in profile which may be somewhat flattened above in some individuals. Propodeal dorsum more or less flat, usually sloping shallowly downwards posteriorly to the evenly rounded junction with the declivity; the alitrunk not saddle-shaped. Metapleural lobes low and rounded. Petiole node relatively large in profile, high, dome-like and evenly rounded, the anterior peduncle without a ventral process. In dorsal view the petiole node longer than broad. Postpetiole in dorsal view slightly broader than long. Base of first gastral tergite in dorsal view not forming a narrow bottle-neck-like constriction. The tergite basally is no wider than the postpetiole but the sides diverge evenly from immediately behind the articulation. Sculpture of head very feeble, faint and even effaced in places, at most consisting of a few weak and superficial irregular rugulae. Ground-sculpture where present only of a weak superficial patterning or shagreening. Dorsal alitrunk transversely rugulose, with or without a patch of longitudinal sculpture on the pronotum and between the mesothoracic spiracles. Rugulae on the propodeal dorsum may be irregular or broken. Petiole and postpetiole dorsally only with superficial patterning, or the former with faint rugular vestiges. Ventral surface of petiole with weak transverse rugulae which may extend up the sides of the node and onto the dorsum, but these are vestigial in some individuals. Dorsal surfaces of head and alitrunk with hairs but these are very rare or even absent on the first gastral tergite. Alitrunk dull red to blackish red, the head a lighter red and the gaster lighter still, orange or even yellow in some individuals.

*O. velox* is one of the seven known species in this genus which lack a conspicuous semicircular impression in the middle of the anterior clypeal margin. The others are *turneri*, *laticeps*, *cursor*, *ankhu*, *zekhem* and *cavatodorsatus*. Of these *turneri* is a small shiny species with large eyes which break the outline of the sides of the head, and *cursor* and *laticeps* have the dorsum of the head strongly sculptured and have the first gastral tergite constricted into a narrow neck basally. *O. cavatodorsatus* shares most characters with *velox*, but the shape of the alitrunk is very different; besides this *cavatodorsatus* is much smaller and has the sculpture of the alitrunk much reduced. Separation of *velox* from *ankhu* and *zekhem* is discussed under those names.

## MATERIAL EXAMINED

South West Africa: Otjiwarongo (*G. Hobohm*). Angola Cahama (*E. S. Ross & R. E. Leech*).

*Ocymyrmex weitzeckeri* Emery

(Fig. 30)

*Ocymyrmex weitzeckeri* Emery, 1892: 116. Syntype workers, LESOTHO: Leribe (*Weitzecker*) (MCSN, Genoa) [examined].

*Ocymyrmex weitzeckeri* subsp. *wroughtoni* Forel, 1910b: 13. Syntype workers, male, SOUTH AFRICA: Natal (*Wroughton*) (MHN, Geneva) [examined]. *Syn. n.*

WORKER. TL 6.8–7.8, HL 1.70–1.80, HW 1.62–1.72, CI 94–99, SL 1.44–1.58, SI 88–94, PW 1.02–1.10, AL 2.16–2.30 (8 measured).

Anterior clypeal margin with a conspicuous semicircular median impression flanked by a pair of short teeth. Occipital margin in full-face view with a median indentation. Maximum diameter of eyes 0.36–0.40, about 0.22–0.23 × HW. Promesonotum evenly convex in profile, the propodeal dorsum flat to very shallowly convex, rounding evenly into the declivity which is almost vertical. Metapleural lobes small but prominent, their apices narrowly rounded. Petiole in profile as in Fig. 30. Petiole node in dorsal view very broad, distinctly broader than long and its width greater than the distance from the spiracle to the apex of the collar where the petiole articulates with the postpetiole. Postpetiole node in dorsal view broader than long (excluding the anterior articulating portion). Base of first gastral tergite strongly constricted behind the

postpetiole and forming a distinct neck. Head finely and densely rugulose everywhere, with punctulate or granular ground-sculpture. Pattern of the rugulae varying between individuals. On the dorsum from the level of the eyes to the occiput the rugulae never all running straight back. Either the rugulae away from the median strip diverge towards the occipital corners, or the rugulae close to the inner or posterior margins of the eyes are irregular to vermiculate; in some the rugulae are extensively vermiculate on the head. Dorsal alitrunk and propodeal declivity transversely rugose except for the area between the mesothoracic spiracles where the sculpture is longitudinal. Other components of the pronotal sculpture arch around the anterior end of these longitudinal rugae. In some workers the pronotum appears to be entirely longitudinally rugose in dorsal view as the median rugae extend so far forward that the more laterally situated rugae must parallel them almost to the cervical shield before arching round. Petiole with a few transverse rugae ventrally which may extend for some distance up the sides; the node with a few weak to vestigial transverse rugulae, those traversing the peduncle in front of the node stronger than those on the node itself. Postpetiole unsculptured except for the usual faint superficial patterning. All dorsal surfaces of head and body with fairly dense pilosity, the hairs of varying length; those on the first gastral tergite shorter and sparser than elsewhere on the body. Colour everywhere dark red to blackish red, in some specimens very dark indeed, almost entirely black.

Known only from the two type-series above and the two short series recorded below, *weitzeckeri* has served as the base from which many infraspecific forms have been described in the past. Of all the names formerly attached to it only *wroughtoni* has proved to be synonymous; the treatment of the remainder is summarized under the synonymic list of species.

#### MATERIAL EXAMINED

**South Africa:** Orange Free State, Donga (*R. W. Slobey*); Transvaal, no loc. (*G. Arnold*).

#### *Ocymyrmex zekhem* sp. n.

**HOLOTYPE WORKER.** TL 8.4, HL 2.06, HW 1.90, CI 92, SL 2.20, SI 116, PW 1.40, AL 2.50.

Anterior clypeal margin entire, without trace of a median notch or impression. Maximum diameter of eye 0.40, about 0.21 × HW, the eyes only just failing to break the outline of the sides in full-face view. Sides of head in front of eyes straight, diverging anteriorly; behind the eyes the sides rounding broadly and evenly into the occipital margin, the latter very shallowly impressed medially in full-face view. Antennal scapes the longest yet known in the genus (see SI, above). With the alitrunk in profile the promesonotum low, evenly shallowly convex. Posterior part of mesonotum and anterior part of propodeum sloping gently downwards posteriorly, the posterior half of the propodeal dorsum levelling off for a short distance before rounding smoothly into the gently convex declivity. Metapleural lobes low and narrow, rounded and only slightly projecting, but not at all concealed by the metapleural gland bulla in absolute profile. Petiole in profile with ventral surface of peduncle shallowly sinuous but without a developed process. Dorsal surface of peduncle also irregular and passing through a blunt angle about one-third the way from the base. Petiole node evenly rounded and dome-like in profile; long and narrow in dorsal view, longer than broad and no broader than the posterior peduncle, the sides of the node scarcely convex. Postpetiole in dorsal view broader than long. Base of first gastral tergite no wider than the postpetiole in dorsal view but not forming a narrow neck; instead the sides of the tergite diverge quickly and evenly from the base. Dorsum of head with sculpture almost effaced, the surface between the eyes with faint narrow longitudinal costulae which are quite close-packed and almost effaced in places. Occipitally the costulae present are even weaker than between the eyes and are transverse. Ground-sculpture between the narrow costulae everywhere vestigial or absent, the surface shining and mostly smooth. Dorsum of pronotum transversely arched-rugose, centrally with an area of longitudinal rugosity; everywhere else the alitrunk transversely rugose. Sides of alitrunk more strongly sculptured than dorsum, the rugae no denser but more sharply defined and more strongly developed. Petiole, postpetiole and gaster unsculptured except for a faint superficial reticular pattern. All dorsal surfaces of head and body with numerous standing hairs. Basal half of first gastral tergite with a number of conspicuous long hairs which are as long as those on the dorsal alitrunk. Head very dark dull red, alitrunk glossy jet black, remainder of body blackish brown but the pedicel segments with a reddish tint. Legs and antennae dark dull red to reddish dark brown, approximately the same colour as the sides of the head.

Holotype worker, **South West Africa:** Tsisab Cyn., Brandberg Mts, 550 m, 11.v.1958 (*E. S. Ross & R. E. Leech*) (CAS, San Francisco).

*O. zekhem* is one of the seven species known in this genus which lack a notch or impression in the anterior clypeal margin. Of these seven species two, *laticeps* and *cursor*, have the base of the first



gastral tergite constricted and forming a narrow neck, which quickly separates them from *zekhem*. Two other species, *turneri* and *cavatodorsatus*, are differentiated from *zekhem* by being much smaller and having shorter scapes, as well as by their possession of specializations not seen in *zekhem*. In *turneri* the eyes are large ( $0.28 \times \text{HW}$ ) and very conspicuously break the outline of the sides of the head in full-face view; in *cavatodorsatus* the alitrunk outline is strongly saddle-shaped. The only other known species which lack a clypeal notch are *ankhu* and *velox*, a close species-pair. In both these species, however, the scapes are shorter than in *zekhem* and the first gastral tergite lacks conspicuous long hairs on the basal half. Such pilosity is distinct in *zekhem* where the hairs are as long as those on the dorsal alitrunk, whereas in both *ankhu* and *velox* hairs are frequently absent from the first tergite, and when present they are very sparse, short and inconspicuous.

### *PRISTOMYRMEX* Mayr

(Figs 33–37)

- Pristomyrmex* Mayr, 1866: 903. Type-species: *Pristomyrmex pungens* Mayr, op. cit.: 904; by monotypy.  
*Odontomyrmex* André, 1905: 207. Type-species: *Odontomyrmex quadridentatus* André, op. cit.: 208; by monotypy. [Synonymy by Mann, 1919: 341.]  
*Hylidris* Weber, 1941: 190. Type-species: *Hylidris myersi* Weber, loc. cit. (= *Pristomyrmex africanus* Karavaiev); by original designation. [Synonymy by Brown, 1953: 9.]  
*Dodous* Donisthorpe, 1946: 145. Type-species: *Dodous trispinosus* Donisthorpe, loc. cit.; by original designation. [Synonymy by Brown, 1971: 3.]

**DIAGNOSIS OF WORKER.** Distal portion of each mandible in anterior view suddenly broadened, much broader than proximal portion. Apical (masticatory) margin usually with 4 teeth arranged as apical + preapical + short diastema + 2 basals, of which the first basal is usually the smallest tooth. An offset basal denticle may also be present as may a tooth about midway on the basal margin. In some species there is a tendency for the two basal teeth to fuse, resulting in a broad basal tooth with two points. With wear these appear as a single broad blunt tooth. Less commonly the mandible with 3 teeth only (apical + preapical + long diastema + single basal), or with 5 teeth. Palp formula usually 1, 3 or 2, 3 (1, 3 in *africanus* and *orbiceps*; 2, 3 in *trogor*; 5 extralimital species also dissected) but higher in *pungens*-group with 4, 3 in *cribrarius* and 5, 3 in *pungens* itself. Lateral portions of clypeus in front of antennal insertions reduced to a thin plate or ridge, often translucent and usually projecting. Median portion of clypeus shield-like, broad between the antennal insertions and frequently with a median carina, its anterior margin prominent and with a projecting apron which is usually equipped with teeth or denticles but sometimes is merely crenulate. Median portion of clypeus projecting over the mandibles when the latter are closed. Frontal lobes reduced or absent so that the articulations of the antennae are mostly or wholly exposed and the roughly circular depressed areas containing the antennal sockets are clearly visible. Frontal carinae variously developed, ranging from absent to conspicuous, sometimes bounded below by a genal carina running longitudinally outside the depressed area of the antennal insertions. Antennae with 11 segments, with a strong 3-jointed apical club. Eyes present in all known species, situated approximately at the midlength of the sides of the head, very variable in size. Alitrunk fusiform, without sutures dorsally. Pronotum often armed with spines, teeth or tubercles of varying size but frequently only with minute prominences or unarmed. Propodeum with a pair of spines or teeth. Propodeal spiracle circular. Metapleural lobes present and usually conspicuous. Orifice of metapleural glands situated some distance up the pleuron, not in the posterior lower corner. Below the gland orifice is a smooth and usually concave area running down towards the coxa, the concave area is bounded by a ridge on each side and appears to be a specialized surface from which the products of the glands may evaporate easily. Petiole nodiform, with a long anterior peduncle. Gaster commonly without hairs or only very sparsely hairy. Sting long and very slender, the apical portion often very thin and hair-like.

Discounting synonyms and infraspecific forms the genus *Pristomyrmex* contains about 38 named species to date. Of these names five valid species belong to the Ethiopian region (see below), six to Australia (Taylor, 1965; 1968), and two to the Malagasy region (Brown, 1971). The remaining 26 names apply to the Oriental/Indo-Australian forms for which no synthesizing taxonomic study has ever been undertaken. Without doubt a proportion of these names represent synonyms and equally without doubt a fair number of new species from these regions await description, so 26 may in fact be a good indication of the actual number of species in the Oriental and Indo-Australian regions, with a preponderance of forms in the latter.



The genus most closely related to *Pristomyrmex* is the monotypic *Perissomyrmex* Smith (1947: 281), which differs mainly in having the antennae with only 9 segments, as opposed to 11 in *Pristomyrmex*. *Perissomyrmex* was based on a couple of specimens intercepted in quarantine in the U.S.A., ostensibly on a ship from Guatemala. But, although Kempf (1972: 182) includes *Perissomyrmex* in his Neotropic catalogue and that area has been tacitly accepted as the place of origin, there is no hard evidence that Guatemala is in fact the original home of the genus. It so resembles *Pristomyrmex* that an Old World origin must be suspected, and the recent discovery by Cesare Baroni Urbani of a second *Perissomyrmex* species in Bhutan (as yet undescribed) adds weight to the argument that South America is not the place of origin but that the specimens of the type-species were brought to the U.S.A., via Guatemala, from somewhere in the Oriental region, or possibly the Indo-Australian region, by human commerce.

Most *Pristomyrmex* species nest in rotten wood, either in fallen twigs in the litter layer or in larger pieces of timber. Some nest in rotten parts of standing trees but most appear to prefer the ground, foraging in the leaf litter and top soil. Of the five African species three, *fossulatus*, *cribrarius* and *trogor*, seem fairly limited in distribution, with the first known from South Africa, the second from South Africa and Mozambique, and the latter only from Zaire. *P. orbiceps* is widely distributed throughout the wet forest zones of west and central Africa whilst the last species, *africanus*, has an extremely wide range and seems able to inhabit woodlands and forests virtually throughout sub-Saharan Africa.

### Synonymic list of species

*africanus* Karavaiev

*myersi* Weber **syn. n.**

*myersi* subsp. *mbomu* Weber **syn. n.**

*myersi* subsp. *primus* Weber **syn. n.**

*myersi* subsp. *beni* Weber **syn. n.**

*cribrarius* Arnold

*fossulatus* (Forel)

*orbiceps* (Santschi)

*laevigatus* Weber **syn. n.**

*trogor* sp. n.

### Key to species (workers)

- 1 Sides of petiole and postpetiole with coarse rugose sculpture. Sides of head behind eyes with abundant short stout projecting straight hairs. (South Africa, Mozambique) . . . . . *cribrarius* (p. 285)
- Sides of petiole and postpetiole smooth and shining. Sides of head behind eyes without projecting straight hairs . . . . . 2
- 2 Frontal carinae absent; the backward projections of the frontal lobes terminating at the ends of the antennal fossae, not reaching back even as far as the level of the anterior margins of the eyes (Fig. 36). Antennal scapes relatively long, SI 100 or more. (Zaire) . . . . . *trogor* (p. 287)
- Frontal carinae present; the backward projections of the frontal lobes running back to or beyond the level of the posterior margins of the eyes (Fig. 37). Antennal scapes relatively short, SI in range 80–94 . . . . . 3
- 3 Eyes relatively small, maximum diameter only 0.12–0.15 × HW, with only 4–5 ommatidia in the longest row. Pronotum armed with a pair of acute teeth or short broad spines. (Extremely widespread in Africa) . . . . . *africanus* (p. 284)
- Eyes relatively large, maximum diameter 0.18–0.29 × HW, with 7 or more ommatidia in the longest row. Pronotum only with a pair of low blunt tubercles, without acute teeth or short spines . . . . . 4
- 4 Head between frontal carinae to occiput smooth and shining, without foveolate punctures. Maximum diameter of eye 0.18–0.21 × HW. Petiole node not wedge-shaped in profile. (Ivory Coast, Ghana, Nigeria, Cameroun, Gabon, Zaire, Angola) . . . . . *orbiceps* (p. 286)
- Head between frontal carinae to occiput with distinct foveolate punctures. Maximum diameter of eye 0.26–0.29 × HW. Petiole node in profile wedge-shaped, roughly triangular and tapering dorsally. (South Africa) . . . . . *fossulatus* (p. 285)

## Treatment by species

*Pristomyrmex africanus* Karavaiev

(Fig. 34)

*Pristomyrmex africanus* Karavaiev, 1931: 47, fig. 5. Holotype worker, KENYA: Mabira, no. 5322 (*Dogiel & Sokolov*) (ZM, Kiev) [examined].

*Hylidris myersi* Weber, 1941: 190, figs 8, 9. Syntype workers, SUDAN: Equatoria, Aloma Plateau, Khor Aba, 3700 ft [1290 m], 10.viii.1939, no. 1470, 1474 (*N. A. Weber*) (BMNH; MCZ, Cambridge) [examined].

**Syn. n.**

*Hylidris myersi* subsp. *mbomu* Weber, 1952: 19. Holotype worker, CENTRAL AFRICAN REPUBLIC: Ubangi-Shari, Bas Mbomu, 5 miles [8 km] W. of Bangassau, 12.iii.1948, no. 2210 (*N. A. Weber*) (AMNH, New York) [examined]. **Syn. n.**

*Hylidris myersi* subsp. *primus* Weber, 1952: 19. Holotype worker, ZAIRE: Stanleyville [Kisangani], 19.iii.1948, no. 2235 (*N. A. Weber*) (AMNH, New York) [examined]. **Syn. n.**

*Hylidris myersi* subsp. *beni* Weber, 1952: 20. Syntype workers, ZAIRE: 15 miles [24 km] N. of Beni, 25.ii.1948, no. 2129 (*N. A. Weber*) (AMNH, New York; MCZ, Cambridge) [examined]. **Syn. n.**

WORKER. TL 2.7–3.4, HL 0.70–0.90, HW 0.68–0.92, CI 97–104, SL 0.62–0.86, SI 85–94, PW 0.46–0.60, AL 0.68–0.92 (20 measured).

Base of mandible with 1–2 fairly strong rugulae present; frequently these fade out distally but in a few they may extend to the apical margin. Apical (masticatory) margin with a strong apical and preapical tooth followed by a diastema and a broad basal tooth formed by the fusion of two basal denticles. Frequently this broad basal tooth shows two points but these are often worn down and only a single blunt prominence remains. Clypeus usually with a median longitudinal carina but this is variously reduced or lost in different samples. Anterior clypeal margin with a median denticle and 1–2 pairs on each side of it, sometimes the lateral pairs not strongly developed. Frontal carinae present, running back to or beyond the level of the posterior margins of the eyes and strongly divergent in their anterior halves. Strongly developed scrobes absent but sides of head between frontal carinae and eyes slightly concave and forming an unsculptured scrobal area. Maximum diameter of eye 0.09–0.12, about 0.12–0.15 × HW and with 4–5 ommatidia in the longest row. With the head in full-face view the occipital margin broadly and shallowly concave to conspicuously indented medially, the sides convex. With the alitrunk in profile the pronotum armed with a pair of acute triangular teeth or short spines; propodeum armed with a pair of spines which are somewhat variable in length and thickness. Metapleural lobes prominent and rounded. Petiole and postpetiole in profile rounded, without acute angles. Shape of petiole node variable but generally as in Fig. 34. Dorsum of head between frontal carinae to occipital margin with foveolate punctures present at least from level of eyes backwards. Both intensity of development and number of punctures very variable; at one extreme the punctures are dense, sharply incised and conspicuous whilst at the other extreme the punctures are sparse, shallow and feebly incised. Sides of head in front of, below, and behind eyes also with foveolate punctures, and punctures usually also present at the posterior end of the scrobal area. Alitrunk unsculptured or at most the dorsum with a few feeble rugular traces on the pronotum. Petiole, postpetiole and gaster unsculptured. Mouthparts, ventral surface and dorsum of head with dense fine pilosity, on the dorsum the hairs arising along the line of the frontal carinae longer than those arising between the carinae. Pronotal dorsum with a transverse row of 3–4 pairs of hairs anteriorly; mesonotum with 3–4 pairs of hairs arising on the lateral margins; propodeum hairless. Petiole, postpetiole and first gastral tergite without hairs but hairs present on apex of gaster. Scapes and tibiae with pubescence, more conspicuous on the former than on the latter. Colour varying from orange-brown to blackish brown, frequently with the gaster darker in shade than the alitrunk and head.

Differentiation of this, the most widely distributed species of this genus, from *orbiceps* is tabulated under the latter name. *P. africanus* separates easily from *cribrarius* as the latter is densely hairy, strongly sculptured, has a palp formula of 4, 3 (as opposed to 1, 3 in *africanus*), and has much larger eyes. *P. trogor* differs from *africanus* as the former lacks frontal carinae and has longer scapes, a less densely hairy alitrunk and lacks foveolate punctures on the dorsum of the head. The foveolate cephalic sculpture seen in *africanus* is, however, also present in *fossulatus*, but in this species the eyes are much larger (0.26–0.29 × HW) and the pronotum has only a pair of blunt tubercles, not sharp teeth such as are seen in *africanus*.

## MATERIAL EXAMINED

**Ghana:** Kibi (*D. Leston*); Mt Atewa (*B. Bolton*). **Cameroun:** Nkoemvon (*D. Jackson*). **Gabon:** Plateau

d'Ipassa (*J. A. Barra*). **Kenya:** 1°25'S, 35°10'W [sic] to 1°38'S, 35°17'E (*N. A. Weber*). **Zaire:** Yangambi (*M. Maldaque*). **Angola:** R. Chicapa, Saurimo (*Luna de Carvalho*); Dundo (no name); Dundo (*Luna de Carvalho*), R. Kahingo (*Mwaoka*); Salazar (*P. M. Hammond*).

*Pristomyrmex cribrarius* Arnold

(Fig. 35)

*Pristomyrmex cribrarius* Arnold, 1926: 281, fig. 81. Holotype female, MOZAMBIQUE: Amatongas Forest (*G. Arnold*) (NM, Bulawayo) [examined].

WORKER. TL 3.2–3.4, HL 0.84–0.90, HW 0.86–0.92, CI 101–102, SL 0.66–0.72, SI 77–79, PW 0.56–0.60, AL 0.82–0.86 (3 measured).

Basal portions of mandibles rugulose but this fading out distally so that the area near the apical margin is mostly or entirely smooth. Apical (masticatory) margin of mandible with three teeth; apical and preapical tooth acute and roughly the same size, behind them is a long diastema followed by the broad and truncated basal tooth. The broad basal tooth may be the result of fusion of two denticles and specimens with a broad-based tooth but a bidenticulate crown must be expected. Clypeus with a strong sharp median longitudinal carina; anterior clypeal margin with a small truncated lobe medially where the carina meets the margin, this lobe flanked on each side by a few smaller denticles which are variable in number and shape. Palp formula 4, 3. Frontal carinae present and strongly divergent, reaching back to, or just beyond, the level of the posterior margins of the eyes. Below the frontal carinae to eye level is a short, weakly impressed scrobal area, bounded below by a weak genal carina which runs above the eye. Eyes large, maximum diameter 0.18–0.20, about 0.21–0.22 × HW and with 9–10 ommatidia in the longest row. With head in full-face view the occipital margin transverse to evenly very feebly concave, not indented medially. Pronotum armed with a pair of short but broad-based acute triangular teeth. Propodeum with a pair of long spines which are slightly sinuate along their length. Metapleural lobes small, bluntly triangular in shape. General shape of alitrunk and pedicel segments as in Fig. 35. Dorsum of head between frontal carinae and back to occipital margin densely covered with broad, shallow foveolate punctures which are much broader than the distances separating them. In places the foveolae are roughly aligned so that the cuticle separating them appears as regular sculpture. Similar sculpture is present below, behind and in front of the eyes, but the scrobal area lacks such sculpture and the clypeus is unsculptured except for the strong median carina. Entirety of dorsal alitrunk with strongly developed but blunt rugae which are predominantly longitudinal. Sides of alitrunk rugulose. Sides and dorsum of petiole node with a few coarse longitudinal rugae. Sides of postpetiole with a few strong rugae, the tergite in profile bounded by a raised ridge or rim. In dorsal view the rim appearing as in Fig. 35, the space between the converging lines being smooth and shiny. Gaster unsculptured. Dorsal surfaces of head, alitrunk, petiole and postpetiole with abundant short erect to suberect hairs. Scapes and tibiae with similar freely projecting hairs and numerous hairs projecting from the sides of the head in full-face view. First gastral tergite without hairs. Colour brown, the gaster darker than the head and alitrunk but the appendages lighter.

This very distinctive species is apparently rare, being known only from the type-collection made in Mozambique and a short series from South Africa noted below. It is easily separable from all the other African *Pristomyrmex* by its dense pilosity, coarse sculpture, high palp formula and oddly shaped postpetiole.

MATERIAL EXAMINED

**South Africa:** Natal, Dukuduku For. Res. (*W. L. & D. E. Brown*).

*Pristomyrmex fossulatus* (Forel)

*Tetramorium* (*Xiphomyrmex*) *fossulatum* Forel, 1910a: 428. Syntype workers, SOUTH AFRICA: Natal, Will Broak [Willbrook] (*Wroughton*) (MHN, Geneva) [examined].

*Pristomyrmex fossulatus* (Forel) Santschi, 1916: 51.

WORKERS. TL 2.7–3.2, HL 0.65–0.72, HW 0.62–0.70, CI 95–97, SL 0.54–0.60, SI 82–90, PW 0.46–0.52, AL 0.68–0.70 (3 measured).

Mandibles with vestiges of striate sculpture basally but mostly smooth with scattered small pits. Apical (masticatory) margin of mandible with strongly developed apical and preapical teeth followed by a diastema and a basal tooth which may be truncated. Clypeus with a sharp median longitudinal carina. Median

portion of clypeus with the anterior margin shallowly concave and armed with denticles; a median denticle and 2–3 others on each side. Frontal carinae present and distinct, running back to the level of the posterior margins of the eyes and forming the dorsal margins of the narrow, short antennal scrobes. Lower margin of scrobe delimited by a longitudinal ruga above the eye, which runs back from the antennal fossa approximately to the midlength of the eye. Eyes large, maximum diameter *c.* 0.18, about 0.26–0.29 × HW, with 8–10 ommatidia in the longest row. With the head in full-face view the side convergent behind the eyes and rounding into the occipital margin which is straight to very feebly and shallowly concave. With the alitrunk in profile the pronotum only with a low, broad, blunt tubercle, without the teeth or spines frequently encountered in this genus; in dorsal view the tubercles appear as low, bluntly rounded angles. Propodeum with a pair of strong spines which are distinctly longer than their basal width. Metapleural lobes narrow and strongly prominent. Petiole in profile wedge-shaped, strongly tapering dorsally and with the apex of the triangular shape blunted. In dorsal view the petiole node broader than long. Subpetiolar process a long narrow low flange. Dorsum of head between frontal carinae with scattered large shallow foveolate punctures. Similar punctures also present on the sides of the head but generally less conspicuous. Dorsal alitrunk also with foveolate punctures but here they are very sparse, widely separated, very shallow and inconspicuous. Apart from these punctate areas the entirety of the head and body smooth and shining, with pedicel segments and gaster completely unsculptured. Hairs present on mouthparts and gastral apex, otherwise the dorsum only with 4–5 pairs on the head behind the level of the antennal insertions, following the line of the frontal carinae; alitrunk with a single pair, on the mesonotum; petiole with 0–1 and postpetiole with 1–2 pairs dorsally; first gastral tergite hairless. Colour glossy light brown.

Known only from the type-series collected in South Africa, *fossulatus* is related to *africanus* and *orbiceps*. It separates easily from the former as its eyes are much larger (0.26–0.29 × HW as opposed to 0.12–0.15 × HW) and its alitrunk lacks the sharp pronotal teeth or broad spines seen in *africanus*. The eye size of *orbiceps* is closer to that of *fossulatus* (but still smaller); *orbiceps* lacks the foveolate cephalic sculpture of *fossulatus* and also lacks the very distinctively shaped petiole node seen in the latter.

### *Pristomyrmex orbiceps* (Santschi)

(Fig. 37)

*Xiphomyrmex orbiceps* Santschi, 1914b: 367, fig. 30. Syntype workers, CAMEROUN: Victoria (*Silvestri*); and GHANA: Aburi (*Silvestri*) (NM, Basle) [examined].

*Pristomyrmex orbiceps* (Santschi) Santschi, 1916: 51.

*Hylidris laevigatus* Weber, 1952: 20, fig. 12. Holotype worker, ZAIRE: 13 miles [21 km] S. of Asa, lat. 4°40'N, long. 25°40'E., 3.iii.1948, no. 2170.1 (*N. A. Weber*) (AMNH, New York) [examined]. **Syn. n.**

WORKER. TL 2.9–3.4, HL 0.72–0.90, HW 0.75–0.94, CI 100–106, SL 0.62–0.74, SI 80–87, PW 0.48–0.62, AL 0.72–0.88 (25 measured).

Base of mandible usually with 1–2 rugulae present but these fading out distally so that the blade near the apical margin is almost or entirely smooth. Apical (masticatory) margin with strong apical and preapical tooth followed by a diastema and a broad basal tooth formed by the fusion of two basal denticles. In many specimens this broad basal tooth shows two points but with wear only a single blunt prominence remains. Clypeus frequently with a weak median longitudinal carina but this tends to be reduced, present only posteriorly, or entirely absent. Anterior clypeal margin equipped with small denticles, usually 5 in number, consisting of a median and 2 on each side. Degree of development of the denticles is variable, ranging from a bluntly crenulate appearance to very distinct. Frontal carinae present, running back at least to the level of the posterior margins of the eyes and strongly divergent in their anterior halves. Strongly developed scrobes absent but the sides between the frontal carinae and the eyes sloping outwards and flat to very shallowly concave. Maximum diameter of eye 0.14–0.19, about 0.18–0.21 × HW and usually with 7–9 ommatidia in the longest row, though in smaller individuals only 6 may be present. With the head in full-face view the occipital margin shallow concave to quite conspicuously indented medially, the sides convex. With the alitrunk in profile the pronotum armed with a low broad blunt tubercle, without the conspicuous acute teeth or spines seen in other species; in dorsal view these tubercles appearing as low bluntly rounded angles. Propodeum armed with a pair of spines which are usually longer than their basal width but which are variable in length and, at minimum, may be only as long as their basal width. Metapleural lobes prominent and rounded. Petiole and postpetiole in profile rounded, without acute angles. Dorsum of head between frontal carinae to occipital margin smooth and highly polished. Sides of head mostly smooth but with some

scattered foveolate punctures in front of, below, and behind the eyes. These punctures are generally fairly conspicuous but in some individuals they may be faint or even vestigial, especially behind the eyes. In most specimens, but especially in larger ones, a few punctures occur on the side of the head on a line linking the posterior margins of the eyes with the posterior extension of the frontal carinae, but these are frequently vestigial or absent. Alitrunk, petiole, postpetiole and gaster unsculptured. Hairs very sparse, present on mouthparts, ventral surface of head and gastral apex, but otherwise as follows. Dorsum of head behind level of antennal insertions with 2–3 pairs of hairs along the line of the frontal carinae. Occipital corners with one pair of hairs, Dorsal alitrunk without hairs except for a single pair on the mesonotum, and this pair is frequently lost by abrasion. Petiole, postpetiole and first gastral tergite without hairs. Scapes and tibiae lacking hairs but with fairly conspicuous pubescence which is usually more obvious on the former than on the latter. Colour uniform blackish brown to black, the appendages lighter.

*P. orbiceps* is a widely distributed species, occurring throughout the wet forest zones of West and Central Africa. Nests are constructed in fallen twigs or larger pieces of wood in the leaf litter layer and workers forage singly in the litter. The separation of *orbiceps* from other African species is straightforward. It differs from *cribrarius* as that species is heavily sculptured and densely hairy. *P. trogor* lacks frontal carinae, has long scapes and relatively small eyes. The widely distributed *africanus* differs from *orbiceps* as follows:

*orbiceps*

Pronotum with a pair of blunt tubercles.

Maximum eye diameter 0·18–0·21 × HW.

Eye with usually 7–9 ommatidia in the longest row (sometimes with 6).

Dorsum of head behind antennal insertions with 2–3 pairs of hairs.

Dorsal alitrunk with 1 pair of hairs.

Head between frontal carinae smooth.

Scapes relatively somewhat shorter, SI range 80–87.

*africanus*

Pronotum with a pair of acute teeth or short spines.

Maximum eye diameter 0·12–0·15 × HW.

Eye with only 4–5 ommatidia in longest row.

Dorsum of head behind antennal insertions with more than 5 pairs of hairs.

Dorsal alitrunk with 4 or more pairs of hairs.

Head between frontal carinae with foveolate punctures, at least posteriorly.

Scapes relatively somewhat longer, SI range 85–94.

## MATERIAL EXAMINED

**Ivory Coast:** Divo (*L. Brader*); Banco For. nr Abidjan (*W. L. Brown*); Orstom Exp. Sta. (*W. L. Brown*). **Ghana:** Kibi (*D. Leston*); Bunso (*D. Leston*); Mampong (*D. Leston*); Mampong (*P. Room*); Tafo (*B. Bolton*); Mt Atewa (*B. Bolton*). **Nigeria:** Gambari (*B. Bolton*); Gambari (*B. Taylor*). **Cameroun:** Nkoemvon (*D. Jackson*). **Gabon:** Plateau d'Ipassa (*J. A. Barra*); Makokou (*W. H. Gotwald*). **Angola:** Dundo (no name).

*Pristomyrmex trogor* sp. n.

(Figs 33, 36)

HOLOTYPE WORKER. TL 4·0, HL 0·96, HW 0·99, CI 103, SL 1·00, SI 101, PW 0·61, AL 0·96.

Mandibles basally with some weak rugular sculpture but this fading out distally so that near the apical margin the blade is smooth. Apical (masticatory) margin with a large apical tooth followed by a slightly smaller preapical, a diastema and two basal denticles which arise at each end of a raised welt representing the fused bases of the two denticles (in worn specimens this would appear as a single broad truncated basal tooth). Median portion of clypeus without a longitudinal median carina except posteriorly where a vestige remains. Anterior clypeal margin with a small median tooth and a couple of smaller denticles on each side. Frontal carinae absent, the posterior extensions of the frontal lobes strongly divergent but short, fading out in front of the level of the anterior margins of the eyes. The genal carina which bounds the outer margin of each antennal fossa strong, curving in towards the extensions of the frontal lobes but not meeting them. Antennal scrobes absent, the scapes relatively long (SI, above). Eyes small, maximum diameter 0·15, about 0·15 × HW. With the head in full-face view the occipital margin indented medially, the sides shallowly but evenly convex. Pronotum armed with a pair of short triangular spines, propodeum with a pair of slightly larger spines; outline shape of alitrunk as in Fig. 33. Metapleural lobes fairly large, rounded. Dorsum of alitrunk flat to shallowly concave between the pronotal spines and between the lateral hair-bearing welts of the mesonotum. Petiole node high in profile, the dorsum sloping downwards posteriorly and rounding into the posterior face. Anterior and dorsal faces of postpetiole in profile forming a single evenly curved surface.

In dorsal view the petiole node about as long as broad, the postpetiole very slightly longer than broad and broadening from front to back. Entirety of head and body smooth and glossy, unsculptured except for a few ridges on the metapleuron leading up to the orifice of the metapleural glands. Dorsum of head with numerous fine curved hairs, some of which are very long. Mandibles, clypeal margin and ventral surface of head with equally dense but generally shorter fine hairs; similar hairs also present on anterior coxa. Alitrunk without hairs except for 2 pairs arising from the mesonotal welt. Petiole, postpetiole and first gastral tergite without hairs; apex of gaster and sternites behind the first with a few hairs present. Scapes and tibiae with short, fine, apically directed hairs. Colour uniform glossy chestnut-brown.

PARATYPE WORKERS. TL 3.4–4.0, HL 0.88–0.96, HW 0.89–0.98, CI 101–103, SL 0.90–0.98, SI 100–102, PW 0.56–0.61, AL 0.86–0.98 (4 measured). Maximum diameter of eye 0.14–0.16, about 0.14–0.16 × HW. As holotype but some darker brown in colour.

Holotype worker, **Zaire** (B. Congo on data label): S. Slope of Mt Kahuzi, 1900 m, 5.ix.1957 (*E. S. Ross & R. E. Leech*) (CAS, San Francisco).

Paratypes, 19 workers and 1 male with same data as holotype (BMNH; MCZ, Cambridge; CAS, San Francisco).

*P. trogor* is related to *africanus*, *fossulatus*, and *orbiceps* but is easily recognizable as in all of these species frontal carinae are strongly developed whereas in *trogor* they are absent, compare Figs 36 and 37. Besides this the antennal scapes in *trogor* are relatively long, with SI 100 or more, whereas the scapes are shorter in *africanus*, *fossulatus* and *orbiceps* with SI range 82–90. *P. africanus* and *fossulatus* also differ from *trogor* by having broad foveolate punctures on the dorsum of the head. *P. orbiceps* lacks the strong pronotal spines seen in *trogor*, having instead a pair of low broad rounded tubercles.

### TERATANER Emery

(Figs 38–55)

*Terataner* Emery, 1912: 103. Type-species: *Atopomyrmex foreli* Emery, 1900: 274; by original designation.

*Tranetera* Arnold, 1952: 130 [as subgenus of *Terataner*]. Type-species: *Atopomyrmex bottegoi* Emery, 1896: 155; by original designation. **Syn. n.**

DIAGNOSIS OF WORKER. Monomorphic arboreal myrmicine ants. Mandibles armed with 5 or 6 teeth. Palp formula 5, 3 (*alluaudi*) or 4, 3 (*bottegoi*, *elegans*, *luteus*, *piceus*, *scotti*). Anterior clypeal margin with a median notch or impression. Median portion of clypeus broad and broadly inserted between the frontal lobes, bounded laterally by a pair of widely separated carinae which run to the anterior margin; lateral portions of clypeus unmodified. Frontal lobes narrow, continuing back into a pair of more or less straight frontal carinae which are usually roughly parallel and relatively close together on the dorsum of the head. Towards the occiput the frontal carinae either fade out or are sharply angled outwards as a ridge or row of tubercles which runs to the sides of the head. Antennal scrobes absent or at most the sides of the head below the frontal carinae with a broad and very shallow concavity. Antennae 12-segmented with a 3-segmented club, the scapes when laid back failing to reach the occipital margin. Eyes large and conspicuous, situated at or in front of the midlength of the head. Occipital corners tuberculate or denticulate in full-face view. Pronotum marginate laterally and usually also anteriorly, the lateral marginations generally simple but sometimes expanded into ornate lobes or flanges. Pronotal shoulders angulate, denticulate or tuberculate in dorsal view. Promesonotal suture absent on the dorsum or represented by a line or slight indentation, only rarely easily visible. Mesonotum usually marginate laterally and forming a low projecting angle or tubercle in dorsal view; rarely immarginate and armed with a sharp denticle laterally. Metanotal groove impressed, most frequently only shallowly so but deep in some species; very shallow indeed in some samples of *elegans*. Propodeum bluntly marginate to rounded laterally, unarmed or with a pair of denticles or teeth. Metapleural lobes large and strongly developed; ventral margin of metapleuron with a strong broad groove running forward from the orifice of the metapleural glands. Ventral surface of alitrunk between hind coxae entire, simple, without a broad deep circular pit. Middle and hind tibiae frequently with a distinct simple spur, the spur reduced in some and indistinguishable from the hairs of the tibial apex in others. Petiole with a short, stout anterior peduncle, the node narrow and tapering dorsally so that it appears triangular or conical in profile. In anterior or posterior view the narrow dorsum of the node either forms a transverse crest or is indented medially so that a pair of blunt prominences are formed laterally. In some these prominences are acute and dentiform, in others developed into quite long teeth; rarely the petiole is strongly bispinose.

In one species (*scotti*) the petiole is developed into a very high plate dorsally which has a central emargination. Postpetiole simple or armed dorsally with a transverse crest or a single spine. Pilosity very variable, some species densely hairy, others almost hairless. Sculpture generally of coarse rugae or sulci, but reduced in the African species *piceus*, *elegans*, *luteus* and *velatus*.

*Terataner* is a small genus of arboreal ants containing 12 species, six of which occur in the Ethiopian region and six in the Malagasy region. Nests are constructed in rotten parts of standing timber, often some considerable distance above the ground. Of the African species four occur quite widely in West and Central African forests (*luteus*, *elegans*, *piceus*, *velatus*), one is East African (*bottegoi*) and the last (*transvaalensis*) is known only from South Africa. The first four named form a complex of closely related species; the last two form a close species-pair which shows marked similarity to the Malagasy species *foreli*, *rufipes*, *steinheili* and *xaltus*. Apart from these Madagascar has another species, *alluaudi*, which is certainly the most bizarre representative of the genus as it is presently understood. The final species of the Malagasy region, *scotti*, is known only from a single worker from the Seychelles. A synopsis of the Malagasy species is given at the end of this section.

Females (queens) are known for a few species and in general show the same characters as the workers, except for the usual modifications associated with this caste. Males are very poorly known, having been recorded only for *elegans*, *scotti* and *foreli*, the total number of specimens amounting to six or seven.

Arnold (1952) proposed a subgenus of *Terataner* which he called *Tranetera*, erected to include only the species *bottegoi* and *transvaalensis*, with the former nominated as type-species. In the same paper he chose to treat *Atopula* Emery as a subgenus of *Terataner*. It has since been shown (Bolton, 1976; 1980) that the type-species of *Atopula*, *A. nodifera* (Emery), is in fact a tetramoriine, and the name *Atopula* has fallen as a straight synonym of *Tetramorium* Mayr.

Turning now to *Tranetera*, it seems probable that Arnold erected this name on the strength of original descriptions alone, and did not see any material other than that of *transvaalensis* which, however, he did recognize as being close to *bottegoi*. From his description of the subgenus only three characters emerge to differentiate *Tranetera* from *Terataner*, namely that in *Tranetera* the promesonotal suture was clearly defined, the metanotal groove (= meso-epinotal suture) was not depressed, and that the petiole was quadrate and without spines. Opposed to this the six species which he left in *Terataner* (*alluaudi*, *foreli*, *luteus*, *rufipes*, *scotti* and *steinheili*; *piceus* is not mentioned and the description of *elegans* had not then appeared) were supposed to have the promesonotal suture obsolete or slightly indented at the sides, the metanotal groove deeply depressed and the petiole not quadrate, armed with two long spines.

Taking the last character, it is obvious when specimens are compared that an almost complete morphocline is present. Only one species has the petiole transverse above, *transvaalensis*, and even here a feeble indentation can be seen; only one species, *alluaudi*, has the petiole strongly bispinose. Between these two extremes the petiole dorsally is indented to emarginate in *bottegoi*, bilobate in *scotti*, shortly and bluntly bidentate in *luteus*, long bidentate in *steinheili*. The presumed separation petiole not quadrate and with two long spines versus petiole quadrate and without spines, does not exist in fact; all major steps between them being bridged in already described species.

Similarly with the degree of definition of the promesonotal suture. It is quite clearly marked in *transvaalensis* (though fused), weakly defined in *bottegoi*, vestigial in *scotti* where it is indicated more by a change in sculpture pattern, almost invisible in *steinheili* where at certain angles the strong sulcate sculpture is very feebly indented along the former track of the suture; obliterated elsewhere. It should be noted that all species have an impression, notch or groove at each side of the dorsum where pronotum and mesonotum meet, which indicates the ends of the former track of the promesonotal suture, and which separates the marginations of the two segments.

Finally, the degree of impression of the metanotal groove varies considerably from species to species. The variation does not allow a split such as that proposed by Arnold and a number of species were incorrectly placed by him, as in *bottegoi* the metanotal groove is impressed where it is as shallow in *luteus* as it is in *transvaalensis*.

Thus the concept of a subgenus *Tranetera* collapses and the name is relegated to the synonymy. In point of fact *Terataner*, as presently constituted, forms a fairly compact genus, within which the following species-complexes can be discerned.

*luteus*-complex (*elegans*, *luteus*, *piceus*, *velatus*). Frontal carinae more or less straight, fading out posteriorly, not angled outwards towards the sides of the head. Sculpture fine. Hairs very sparse and scattered or absent on first gastral tergite. Dorsal (outer) surfaces of middle and hind tibiae without projecting hairs. West and Central Africa.

*foreli*-complex (*bottegoi*, *foreli*, *rufipes*, *scotti*, *steinheili*, *transvaalensis*, *xaltus*). Frontal carinae angled outwards posteriorly, running across the head either to the sides or towards the occipital corners as a crest, ridge or row of tubercles. Sculpture coarse. Hairs dense and very conspicuous on first gastral tergite. Dorsal (outer) surfaces of middle and hind tibiae with projecting hairs. East and South Africa, Madagascar, Seychelles.

*alluaudi*-complex (*alluaudi*). As *foreli*-complex but frontal carinae feeble, sometimes almost indistinguishable from the cephalic sculpture, not running transversely on the head posteriorly. Postpetiole with a single long median dorsal spine. Margins of pronotum expanded into a pair of broad laminae. Madagascar.

*Terataner* belongs to a group of genera which also includes the African genus *Atopomyrmex* André, the Oriental/Indo-Australian genus *Dilobocondyla* Santschi and the predominantly Australian genera *Dacryon* Forel, *Peronomyrmex* Viehmeyer, *Podomyrma* F. Smith and *Pseudopodomyrma* Crawley (Taylor, 1970). Possibly also the strange monotypic genus *Ireneopone* Donisthorpe of Mauritius belongs to this assemblage. As can be seen, the only other African genus noted is *Atopomyrmex*; the two are separated as follows in the worker.

<i>Terataner</i> Monomorphic	<i>Atopomyrmex</i> Polymorphic
Occipital corners tuberculate or denticulate.	Occipital corners evenly rounded.
Ventral surface of alitrunk simple and entire, without a broad deep pit between the hind coxae.	Ventral surface of alitrunk with a very conspicuous broad deep pit between the hind coxae.
Lower margin of metapleuron with a broad groove running forward from the orifice of the metapleural glands. (Figs 38, 39, 50–55).	Lower margin of metapleuron without such a groove, the margin rounded and folded in so that the hind coxa appears to rest on the bulla of the metapleural glands (Figs 3, 4).
Frontal carinae close together, long, usually approximately parallel, running back well beyond the level of the eyes (Figs 42–45).	Frontal carinae absent in smallest workers, lengthening as size increases, running back beyond the eyes only in large workers; when present always very broadly separated and distinctly divergent anteriorly (Figs 5–7).
Propodeum unarmed to bidentate.	Propodeum with a pair of long spines.

### List of species

*bottegoi* (Emery)  
*elegans* Bernard  
*luteus* (Emery)  
*piceus* Menozzi  
*transvaalensis* Arnold  
*velatus* sp. n.

### Key to species (workers)

- 1 Dorsal (outer) surfaces of hind tibiae with projecting hairs. With the head in full-face view the frontal carinae posteriorly sharply angled outwards, forming a ridge or row of tubercles which runs towards the sides (Figs 42, 43) . . . . . 2
- Dorsal (outer) surfaces of hind tibiae without projecting hairs. With the head in full-face view the frontal carinae fading out posteriorly in a straight line, not sharply angled outwards (Figs 44, 45) . . . . . 3



- 2 Eyes more or less flat, not or only weakly breaking the outline of the sides of the head in full-face view (Fig. 43). Sides of pronotum in dorsal view strongly convergent posteriorly (Fig. 47). Black species; dorsal surfaces of alitrunk with abundant stout hairs. (Somali Republic, Kenya, Tanzania) . . . . . *bottegoi* (p. 291)
- Eyes convex, conspicuously breaking the outline of the sides of the head in full-face view (Fig. 42). Sides of pronotum in dorsal view roughly parallel, not strongly convergent posteriorly (Fig. 46). Head and gaster black, alitrunk red; dorsal surfaces of alitrunk with sparse short hairs. (South Africa) . . . . . *transvaalensis* (p. 294)
- 3 With the postpetiole in dorsal view the posterior arch of the dorsum very broad and broadly rounded (Fig. 41) . . . . . 4
- With the postpetiole in dorsal view the posterior arch of the dorsum narrow and narrowly rounded (Fig. 40) . . . . . 5
- 4 Yellow. Pronotal dorsum distinctly broader than long (Fig. 49). Pronotal width almost equalling to distinctly exceeding the combined lengths of pronotum and mesonotum in dorsal view. (Ghana, Cameroun) . . . . . *luteus* (p. 293)
- Dark brown to black, the alitrunk usually reddish, lighter than the head and gaster. Pronotal dorsum about as long as broad (Fig. 48). Pronotal width less than the combined lengths of pronotum and mesonotum in dorsal view. (Guinea, Ghana, Nigeria) . . . . . *elegans* (p. 292)
- 5 First gastral tergite without hairs. Pronotal dorsum reticulate-punctate, without strong longitudinal rugulae (Ghana, Nigeria, Cameroun, Equatorial Guinea) . . . . . *piceus* (p. 293)
- First gastral tergite with strong hairs on basal half. Pronotal dorsum reticulate-punctate and with strong overlying longitudinal rugulae. (Ivory Coast, Ghana). . . . . *velatus* (p. 295)

### Treatment by species

The six species known from the Ethiopian zoogeographical region are discussed below in alphabetical order.

#### *Terataner bottegoi* (Emery)

(Figs 39, 43, 47)

*Atopomyrmex bottegoi* Emery, 1896: 155, fig. Holotype worker, SOMALI REPUBLIC: Lugh (*V. Bottego*) (MCSN, Genoa) [examined].

*Terataner bottegoi* (Emery) Emery, 1912: 103.

WORKER. TL 4.8–6.0, HL 1.24–1.42, HW 1.12–1.34, CI 90–94, SL 0.76–0.90, SI 67–69, PW 0.90–1.12, AL 1.46–1.64 (5 measured).

Mandibles delicately longitudinally striate to almost smooth. Frontal carinae sharply developed as a pair of raised ridges which are set quite close together on the dorsum and which are almost parallel, only very slightly divergent and feebly sinuate along their lengths. Posteriorly each carina angles sharply outwards, running towards the sides of the head as a weak ridge or row of linked tubercles. The frontal carinae and their transverse posterior extensions form the borders of a weakly defined and shallowly impressed scrobal area on each side. Eyes flat to extremely feebly convex, not prominent, maximum diameter 0.26–0.30, about 0.22–0.24 × HW. Pronotum in dorsal view marginate anteriorly and laterally, the lateral marginations projecting and overhanging the sides. In dorsal view the pronotal corners sharply angulate to denticulate and the sides distinctly convergent posteriorly. Sides of pronotum without a sharp strong margin running between the anterodorsal and the anteroventral corners. Mesonotum marginate laterally; propodeum with sides separated from dorsum by a blunt angle. Promesonotal suture visible at the sides of the dorsum but usually absent centrally; however, in a few larger workers a faint track is visible arching across the dorsum. Metanotal groove impressed, the propodeal dorsum sloping downwards posteriorly. Propodeum armed with a pair of denticles, a pair of minute blunt tubercles, or unarmed. No two workers of the five seen have the same propodeal armament. Metapleural lobes large and rounded. Petiole node roughly triangular in profile, rising to a point dorsally. In anterior view the dorsum very shallowly impressed and the corners rounded, not projecting as teeth. Dorsum of head strongly longitudinally rugose between the frontal carinae, the rugae quite widely separated and the spaces between them filled with dense fine reticulate-punctate ground-sculpture. Sides of head between frontal carina and eye with similar dense ground-sculpture. In the upper part of this scrobal area the punctulation is the only sculpture present, but in the lower half it is overlaid by a series of rugae which became stronger closer to the eye; none of these rugae are as strong as those on the dorsum. Sides of head below eye with regular strong, more or less parallel, longitudinal rugae.

Pronotal dorsum longitudinally rugose, the rugae becoming finer and less regular away from the midline but present right up to the lateral marginations. Mesonotum similarly sculptured. Propodeal dorsum with a few short rugae anteriorly but these fade out posteriorly leaving only the reticulate-punctate ground-sculpture. Sides of alitrunk with regular more or less parallel longitudinal rugae. Petiole and postpetiole with reticulate-punctulate ground-sculpture, the anterior face of the petiole node only with such sculpture but the posterior face of the node and the dorsum of the postpetiole also with coarse rugose to almost sulcate sculpture. First gastral tergite finely and superficially densely reticulate-punctulate, the base of the tergite also finely longitudinally costulate. All dorsal surfaces of head and body with numerous conspicuous stout hairs which are white to silvery in colour. Dorsal surfaces of middle and hind tibiae with standing hairs, but such hairs absent from leading edges of antennal scapes. Colour black, the appendages brown.

Together with *transvaalensis*, *bottegoi* forms the African mainland representation of the predominantly Malagasy *foreli*-complex of this genus. Characters useful in separating the two species are discussed under *transvaalensis*.

#### MATERIAL EXAMINED

**Kenya:** Diani Beach (*N. L. H. Krauss*); Simu Beach, Kwale (*E. S. Ross & R. E. Leech*). **Tanzania:** Mafia I. (*Vesey-Fitzgerald*).

### *Terataner elegans* Bernard

(Figs 41, 45, 48)

*Terataner elegans* Bernard, 1952: 243. fig. 13A. Holotype female, GUINEA: Kéoulenta (*Lamotte*) (MNHN, Paris) [examined].

WORKER. TL 4.9–5.6, HL 1.18–1.40, HW 1.12–1.30, CI 92–97, SL 0.72–0.82, SI 58–65, PW 0.78–0.88, AL 1.50–1.76 (20 measured).

Mandibles weakly longitudinally rugulose to almost smooth, frequently with distinctive large pits close to the masticatory (apical) margin. Frontal carinae a pair of close-set straight, almost parallel ridges which fade out posteriorly between the level of the posterior margins of the eyes and the occiput. Antennal scrobes absent. Maximum diameter of eye 0.24–0.28, about 0.22–0.24 × HW. Pronotum in dorsal view marginate anteriorly and laterally, with strongly angulate or short-denticulate anterior corners. On sides of the pronotum margination runs from the anterodorsal to anteroventral angles. Mesonotum marginate laterally and propodeum also with lateral margination though here it is much less sharply defined than on the pronotum and in a few specimens is better described as bluntly angular. Lateral parts of promesonotal suture visible on dorsum but centrally it is usually completely effaced. Metanotal groove feebly indicated in profile by a shallow concavity or feeble indentation. Dorsum of pronotum about as long as broad, its width obviously less than the combined lengths of the pronotum and mesonotum. Propodeum unarmed. Petiole node low-triangular in profile, rising to a dorsal peak. In anterior view the dorsal margin of the node strongly emarginate medially, the portions on each side of the emargination appearing as a pair of stout tubercles or blunt teeth. Postpetiole in dorsal view flattened, in some the dorsum appearing shallowly longitudinally concave; the posterior margin of the postpetiolar dorsum broad and broadly rounded. Dorsum of head between frontal carinae with superficial but dense punctulate to granular ground-sculpture, and with a few very weak longitudinal rugulae which are commonly broken or interrupted. Sides of head above eyes with the same ground-sculpture and also with longitudinal rugulae which are usually somewhat stronger than those on the dorsum. Dorsal alitrunk finely and densely reticulate-punctulate and with feeble longitudinal rugulae, at least on the promesonotum. Postpetiole dorsally with a few stout conspicuous rugae. First gastral tergite shagreened to finely superficially punctulate, with fine costulae on the basal portion. Hairs very sparse on dorsal surfaces of head and body, present on mouthparts and gastral apex but otherwise the maximum complement seeming to be 3–4 pairs on the head along the lines of the frontal carinae, one pair on the pronotal corners, one pair on the propodeum, one pair on the posterior face of the petiole node and 1–2 pairs each on the postpetiole and first gastral tergite. These hairs appear to be lost easily by abrasion and completely hairless individuals are frequent. Scapes and tibiae without standing hairs of any description. Colour usually with head and gaster blackish brown to black, the alitrunk lighter brown or more usually reddish. Mandibles and clypeus usually lighter in colour than rest of head.

The four known species of the *luteus*-complex are confined to the forests of West and Central Africa. The complex is diagnosed by the short straight frontal carinae which fade out on the head behind the level of the eyes, fine sculpture, and sparse pilosity on the body; the tibiae lack

standing hairs. Of the species thus defined two, *elegans* and *luteus*, have a broad flattened postpetiole, the posterior dorsal margin of which is broad and very broadly, evenly rounded. The other two species, *piceus* and *velatus*, have the posterior arch of the postpetiole narrow and narrowly rounded in dorsal view, compare Figs 40 and 41.

*T. elegans* and *luteus* are very closely related, being separated mainly on colour (*luteus* is uniformly yellow), and on the dimensions of the pronotum as noted in the key. Apart from this the pronotum of *luteus* in dorsal view usually has the lateral margins more strongly convex than in *elegans* (Figs 48 and 49), though in smaller individuals this difference is often unapparent.

#### MATERIAL EXAMINED

**Ghana:** Tafo (*C. Campbell*); Tafo (*B. Bolton*); Kunso (*D. Cross*); Adeiso (*D. Leston*); Bunso (*D. Leston*); Sajimasi (*D. Leston*); Aburi (*P. Room*). **Nigeria:** Ife (*B. Taylor*).

### *Terataner luteus* (Emery)

(Figs 38, 44, 49)

*Atopomyrmex luteus* Emery, 1899: 477. Syntype workers, CAMEROUN (*Conradt*) (MCSN, Genoa; MCZ, Cambridge) [examined].

*Terataner luteus* (Emery) Emery, 1912: 103.

WORKER. TL 5.0–5.8, HL 1.22–1.40, HW 1.16–1.32, CI 94–98, SL 0.74–0.80, SI 59–66, PW 0.86–1.04, AL 1.52–1.78 (15 measured).

Answering to the description of *elegans* and very closely related to it. *T. luteus* differs from *elegans* as follows.

#### *luteus*

Colour uniform dull yellow.

Pronotum broader than long, the pronotal width about equalling or distinctly exceeding the combined lengths of the pro- and mesonotum in dorsal view.

At least in larger specimens the sides of the pronotum in dorsal view distinctly convex (Fig. 49).

Ground-sculpture on dorsum of head very feeble, sometimes almost effaced.

#### *elegans*

Colour blackish brown to black on head and gaster, alitrunk reddish or lighter brown.

Pronotum about as long as broad, the pronotal width less than the combined lengths of the pro- and mesonotum in dorsal view.

In all specimens the sides of the pronotum in dorsal view only very feebly convex (Fig. 48).

Ground-sculpture on dorsum of head superficial but dense and distinct.

#### MATERIAL EXAMINED

**Ghana:** Kade (*D. Leston*); Bunso (*D. Leston*).

### *Terataner piceus* Menozzi

(Fig. 40)

*Terataner piceus* Menozzi, 1942: 173. Holotype worker, EQUATORIAL GUINEA: Rio Benito, 1939–40 (*H. Eidmann*) (holotype not found in IE, Bologna; presumed lost).

WORKER. TL 4.6–5.5, HL 1.12–1.28, HW 1.06–1.20, CI 94–98, SL 0.64–0.70, SI 59–62, PW 0.75–0.84, AL 1.38–1.54 (9 measured).

Mandibles smooth with scattered large pits, those nearest the apical (masticatory) margin frequently elongate. Frontal carinae straight, close together and approximately parallel, fading out between the level of the posterior margins of the eyes and the occiput. Maximum diameter of eyes 0.26–0.30, about 0.25–0.27 × HW. Pronotum marginate laterally and more weakly so anteriorly, the pronotal angles bluntly denticulate and prominent. Sides of pronotum somewhat convergent posteriorly. Mesonotum marginate laterally, the propodeal dorsum separated from the sides by a blunt angle, not nearly so sharply marginate as the pronotum. Promesonotal suture absent from dorsum except laterally where it forms a break between the pronotal and mesonotal marginations. With the alitrunk in profile the metanotal area shallowly impressed. Propodeum unarmed or at most with a pair of minute low blunt tubercles where the sloping dorsum meets the declivity proper. Metapleural lobes large and rounded. Petiole node in profile appearing as a broad-based short triangular tooth, tapering to a point apically and slightly curved backwards. In anterior view the dorsum of the petiole quite broadly and deeply impressed, the portion on each side of the

impression projecting as a blunted tooth which is directed slightly outwards. Postpetiole in dorsal view with the arch of the posterodorsal surface narrow and narrowly rounded. Dorsum and sides of head above eyes covered with fine reticulate-punctulate ground-sculpture which is usually weaker between the frontal carinae than elsewhere. Superimposed on this are a few weak fine longitudinal rugulae between the frontal carinae and some stronger rugulae on the sides of the head above the eye. In this latter position cross-meshes are frequently developed between the longitudinal components, more strongly so in front of the level of the eye than behind it. Dorsal alitrunk finely and densely reticulate-punctulate, without trace of rugular sculpture on the promesonotum. Pedicel segments and gaster similarly but more lightly sculptured. Basigastral costulae very reduced, short and inconspicuous, restricted to the small area immediately behind the postpetiolar-gastral junction. Hairs on dorsal surfaces of body very sparse, present on mouthparts and gastral apex but otherwise the fullest complement seeming to be 3-4 pairs on head along the lines of the frontal carinae, 1 pair each on mesonotum and propodeum (but none on pronotum in any specimens seen), 1-2 pairs on petiole behind node, 2-3 pairs on postpetiole, none on first gastral tergite. Outer surfaces of middle and hind tibiae and antennal scapes without standing hairs. Colour uniform mid-brown to blackish brown.

Of the *luteus*-complex of species two, *piceus* and *velatus*, are diagnosed by the shape of the postpetiole which in dorsal view is narrow and narrowly rounded posteriorly, rather than being broad and broadly evenly rounded posteriorly as is the case in *elegans* and *luteus*, compare Figs 40 and 41. *T. piceus* is separated from *velatus* by its lack of rugular sculpture on the promesonotum and lack of hairs on the first gastral tergite.

#### MATERIAL EXAMINED

**Ghana:** Sajimasi (*D. Leston*); Aburi (*D. Leston*); Mampong (*P. Room*). **Nigeria:** Gambari (*B. Bolton*). **Cameroun:** Nkoemvon (*D. Jackson*).

### *Terataner transvaalensis* Arnold

(Figs 42, 46)

*Terataner* (*Tranetera*) *transvaalensis* Arnold, 1952: 130, fig. Holotype worker, SOUTH AFRICA: e. Transvaal, Marieps (or Mariepskop), v.1951 (*J. C. Faure*) (NM, Bulawayo) [examined].

**WORKER.** TL 6.8, HL 1.60, HW 1.58, CI 98, SL 1.08, SI 68, PW 0.94, AL 2.02.

Mandibles longitudinally rugulose. Frontal carinae strongly developed as a pair of sharp raised ridges which are almost parallel throughout their length, only very feebly sinuate. Posteriorly each frontal carina angled sharply outwards and running towards the side of the head as a weak ridge. Antennal scrobes absent but the head with a narrow indentation below the frontal carinae. Eyes convex and conspicuous, maximum diameter 0.32, about 0.20 × HW. Pronotum in dorsal view marginate anteriorly and laterally, the anterior corners prominently angulate; these angles also forming the origin of a sharp margin running down the sides of the pronotum to the anteroventral angles. Sides of pronotum only very feebly sinuate in dorsal view, roughly parallel, not strongly convergent posteriorly. Mesonotum marginate laterally, propodeum not marginate. Promesonotal suture feeble medially on dorsum but its track visible; strongly defined laterally on the dorsum where it separates the pronotal and mesonotal marginations. With alitrunk in profile the metanotal region very shallowly concave only, not distinctly impressed. Propodeum rounded and unarmed, without trace of teeth. Metapleural lobes conspicuous, large and rounded. Petiole node broadly triangular in profile, rising to a peak dorsally. In anterior view the dorsum of the petiole indented medially, the dorsum on each side of the indentation rounded, not developed into teeth. Dorsum of head with 11 sharp longitudinal rugae between the frontal carinae at the level of the posterior margins of the eye. Sides of head between frontal carinae and eyes more strongly rugose than dorsum and sides below eyes more strongly rugose still, almost sulcate. Ground-sculpture on all surfaces of head a fine and very dense reticulate-punctulation. Dorsal alitrunk sculptured with very broad low strong longitudinal rugae, almost sulcate. On the pronotum these strong rugae are roughly parallel and are restricted to the central, transversely convex, portion and do not occur on the flatter more lateral areas close to the lateral marginations. On the mesonotum the rugae become weaker posteriorly and are distinctly divergent. On the propodeal dorsum the rugae are broader and even less well defined. Sides of alitrunk bluntly rugose, on the pronotum the rugae diagonal and running from the anteroventral to the posterodorsal angle. Elsewhere on the sides the rugae longitudinal, coarsest on the propodeum above the spiracle. Ground-sculpture of entire alitrunk a fine and very dense reticulate-punctulation. Anterior face of petiole node with dense punctulate ground-sculpture and a few rugular vestiges but posterior face deeply sulcate, the sulci regular and parallel. Postpetiole sulcate in dorsal view,

the sculpture divergent posteriorly and overlaid by punctulate ground-sculpture. First gastral tergite densely reticulate-punctulate everywhere and with strong longitudinal costulae or rugae on the basal quarter. All dorsal surfaces of head and body with short, quite stout hairs. These are quite numerous on head, pedicel segments and gaster but are decidedly sparser on the alitrunk, being obvious only on the pronotum where several pairs are present, but apparently represented by only a single pair each on the mesonotum and propodeum. Dorsal surfaces of femora and tibiae and also leading edges of antennal scapes with scattered stout standing hairs. Head and gaster blackish brown to black, alitrunk and appendages red.

*T. transvaalensis*, known only from the holotype worker, is one of the two African species referable to the predominantly Malagasy *foreli*-complex. The other species in Africa is *bottegoi*. The two are separated by the characters given in the key and by the fact that *bottegoi* tends to be somewhat smaller than *transvaalensis*. Also, in *transvaalensis* the rugose sculpture of the pronotal dorsum does not run to the lateral marginations, the lateral marginations of the pronotum do not overhang the sides of the pronotum, the metanotal area is not sharply impressed and the side of the head between the eye and frontal carina is more strongly rugose than the dorsum. In contrast the rugose sculpture of the pronotal dorsum runs to the lateral marginations in *bottegoi*, the lateral pronotal marginations overhang the sides, the metanotum is sharply impressed and the side of the head between eye and frontal carina is less strongly rugose than the dorsum of the head.

At present the ranges of the two are not known to overlap; *transvaalensis* is known only from Transvaal, South Africa, whilst *bottegoi* has been recorded from Somali Republic, Kenya and Tanzania.

#### *Terataner velatus* sp. n.

HOLOTYPE WORKER. TL 4.5, HL 1.14, HW 1.07, CI 94, SL 0.64, SI 60, PW 0.76, AL 1.40.

Mandibles smooth basally but in the apical halves with a number of large elongate pits which, where aligned, give the appearance of short impressions. Frontal carinae fine, close together, parallel, more or less straight, fading out on the dorsum between the level of the posterior margins of the eyes and the occiput. Maximum diameter of eyes 0.27, about 0.25 × HW. Pronotum marginate laterally and more weakly so anteriorly, the pronotal corners bluntly dentate and prominent. Sides of pronotum shallowly convex and somewhat convergent posteriorly. Mesonotum marginate laterally, the propodeal dorsum separated from the sides by a blunt angle, not at all as sharply marginate as the pronotum. Promesonotal suture absent on dorsum except laterally where it forms a break in the margination. Metanotal groove only very shallowly impressed in profile. Propodeum unarmed. Metapleural lobes large and rounded. Petiole node in profile appearing as a triangular tooth, broad-based but short, tapering to an acute point apically and very slightly curved backwards. In anterior view the dorsal surface of the node strongly emarginate in the middle, the portions on each side of the emargination projecting slightly outwards as a pair of blunt teeth. Postpetiole in dorsal view narrow and narrowly rounded posteriorly. Dorsum of head and sides of head above the eyes with a fine dense reticulate-punctulate ground-sculpture which is fainter between the frontal carinae than outside them. Overlying the ground-sculpture are a few fine longitudinal rugulae between the frontal carinae and a series of somewhat stronger longitudinal rugulae running above the eye. Dorsal alitrunk finely and densely reticulate-punctate everywhere. On the propodeal dorsum this is the only sculpture but the pronotum, and to a lesser extent the mesonotum, has fine but conspicuous fairly dense longitudinal rugulation. Petiole, postpetiole and first gastral tergite finely and densely reticulate-punctate everywhere. Basigastral costulae very reduced, the individual components short, fine and restricted to the area immediately behind the postpetiolar-gastral junction. Standing hairs sparse on dorsal surfaces of the body, consisting only of 4 pairs on the head following the lines of the frontal carinae, one pair each on the pronotum (at the corners), mesonotum and propodeum, 3 pairs each on the petiole and postpetiole, and 3 pairs on the first gastral tergite situated in the basal half towards the sides of the sclerite. Other than this hairs are present only on the mouthparts and gastral apex; standing hairs are absent on the scapes and tibiae. Colour uniform dark brown.

PARATYPE WORKERS. TL 4.1-4.4, HL 1.04-1.10, HW 0.98-1.06, CI 94-96, SL 0.60-0.64, SI 60-64, PW 0.70-0.74, AL 1.24-1.36 (5 measured). Maximum diameter of eye 0.24-0.26, about 0.24-0.25 × HW. As holotype but several paratypes with hairs variously lost by abrasion from the dorsal body surfaces. Colour varying from mid-brown to blackish brown.

Holotype worker, **Ghana**: Okumaning, 12.viii.1969, ant ecology sample K12 (*D. Leston*) (BMNH).

Paratypes. **Ghana**: 1 worker with same data as holotype but sample K11; 1 worker, Kade, ant ecology sample K96 (*D. Leston*); 2 workers, Enchi, 17.v.1969, ant ecology sample E 5-8 (*D. Leston*). **Ivory Coast**: 1 worker, Banco Forest near Abidjan, 10.i.1963, no. A30 (*W. L. Brown*). (BMNH; MCZ, Cambridge.)

*T. velatus* is closest related to *piceus* in the *luteus*-complex, the two species sharing the characteristic form of the postpetiole which in dorsal view is narrow and narrowly rounded posteriorly. The two are easily separated as *velatus* has longitudinal rugular sculpture on the pronotum which overlies the dense reticulate-punctulate ground-sculpture, whilst in *piceus* such rugulae are absent. Besides this *velatus* has hairs present on the basal half of the first gastral tergite where in *piceus* such hairs are lacking.

### Synopsis of Malagasy region species

#### *Terataner alluaudi* (Emery)

(Fig. 50)

*Atopomyrmex alluaudi* Emery, 1895: 341, fig. 2. Syntype workers, MADAGASCAR: Diego-Suarez, iv-viii.1893 (*C. Alluaud*) (MCSN, Genoa; MCZ, Cambridge) [examined].

*Terataner alluaudi* (Emery) Emery, 1912: 103.

#### *Terataner foreli* (Emery)

(Fig. 55)

*Atopomyrmex foreli* Emery, 1900: 274, figs. Syntype workers, MADAGASCAR: Baia di Antongil, 1897-98 (*A. Mocquerys*) (MCSN, Genoa) [examined].

*Terataner foreli* (Emery) Emery, 1912: 103.

#### *Terataner rufipes* Emery

(Fig. 53)

*Terataner rufipes* Emery, 1912: 104. Holotype worker, MADAGASCAR: Fort Dauphin (*M. Sikora*) (MCSN, Genoa) [examined].

#### *Terataner scotti* (Forel)

(Fig. 51)

*Atopomyrmex scotti* Forel, 1912: 160. Syntype worker and males, SEYCHELLES: Praslin I. (worker), and Silhouette I. (males) (*H. Scott*) (BMNH) [examined].

*Terataner scotti* (Forel) Emery, 1912: 103.

#### *Terataner steinheili* (Forel)

(Fig. 54)

*Atopomyrmex steinheili* Forel, 1895: 485. Holotype worker, MADAGASCAR: 'Madagascar central' (*M. Sikora*) (MHN, Geneva) [examined].

*Terataner steinheili* (Forel) Emery, 1912: 103.

#### *Terataner xaltus* sp. n.

(Fig. 52)

HOLOTYPE WORKER. TL 8.0, HL 1.82, HW 1.78, CI 98, SL 1.16, SI 65, PW 1.50, AL 2.22.

Mandibles with 6 teeth; with strong rounded longitudinal rugular sculpture. Median portion of clypeus bounded by a carina on each side which runs to the anterior margin. Median clypeal carina present, running

to the clypeal notch. On each side of the median carina the clypeus with 2–3 weaker carinae which may be broken or discontinuous. Eyes large, maximum diameter 0.40, about  $0.22 \times \text{HW}$ , situated approximately at the midlengths of the sides and breaking the outline of the sides in full-face view. Frontal carinae sharply developed, roughly parallel and about  $0.76$  apart ( $c. 0.43 \times \text{HW}$ ) at the level of the midlength of the eyes. Posteriorly the frontal carinae sharply divergent and running towards the occipital corners as a raised crest on each side. Lateral margins of pronotum extended outwards as a semitranslucent lamella on each side, the maximum width of which is  $c. 0.14$ . On the left side of the holotype the lamella is continuous from the pronotal corner but on the right the corner forms a separate angle, separated from the lamella proper by an indentation. Pronotum (including the lamellae) much broader than long. Promesonotal suture absent on dorsum centrally, but its former track indicated by a feeble indentation running across the unbroken strong longitudinal sculpture. Lateral parts of promesonotal suture on the dorsal alitrunk, and its track down the sides of the alitrunk, represented by a conspicuous cleft filled with very dense off-white pubescence. Mesonotum not marginate but armed with a low broad tubercle on each side. Promesonotum convex both longitudinally and transversely. Metanotal groove impressed, narrow. Propodeum weakly and irregularly marginate laterally, armed with a pair of small denticles. Dorsum of propodeum rounding evenly into the short declivity; the dorsum between the denticles transversely shallowly concave. Metapleural lobes conspicuous, deep and broad. Peduncle of petiole thick, with a low and rounded anterior process ventrally. Petiole node in profile low and roughly triangular, tapering dorsally to a narrow peak which is inclined backwards from the vertical. In anterior view the dorsum of the petiole node emarginate and armed with a pair of low, broad triangular teeth. Postpetiole in profile rising to a sharp peak dorsally. In dorsal view this peak is seen to be the topmost point of a knife-edged transverse crest which falls away on each side, separating the anterior face of the postpetiole from the rest. Dorsum of head between the frontal carinae with eight roughly parallel, quite widely separated, strong longitudinal costae; the spaces between them with superficial granular ground-sculpture. Sides of head between frontal carinae and eye rugose, with granular ground-sculpture between the rugae and with a few cross-meshes above and in front of the eye. Sides of head below and behind eye strongly sulcate. Sides of pronotum strongly sulcate, the sulci inclined slightly backwards from the vertical. Remainder of sides of alitrunk longitudinally rugose except in the area below the propodeal margin where the rugae are irregular. Promesonotal dorsum strongly and regularly longitudinally sulcate. Propodeal dorsum with some longitudinal rugulae on the anterior half but behind this the surface merely superficially reticulate. Anterior faces of both petiole and postpetiole with fine superficial reticulation, the latter also with some low rugae which radiate from the petiolar junction. Posterior faces of both segments with coarse rugae. Basal third of first gastral tergite densely longitudinally costulate, the spaces between the costulae smooth or nearly so. Posteriorly, as the costulae fade out, a fine superficial reticulation or shagreening fades in, and this continues to the hind margin of the sclerite. All dorsal surfaces of head and body with numerous short white hairs. Femora and tibiae with numerous standing hairs. Black, the mandibles, antennae and legs dark brown.

Holotype worker, **Madagascar**: Forêt de Zombitsy, near Sakaraha, 650 m, 16.xii.1959 (no collector's name) (MCZ, Cambridge).

The shape of the postpetiole allies *xaltus* to *rufipes*, but this latter is a much smaller species with simple pronotal margination and less regular pronotal sculpture. The following key will separate the known species of the Malagasy region.

### Key to species (workers)

- 1 Postpetiole armed dorsally with a single median curved spine (Fig. 50). Petiole with a pair of long, usually back-curved, spines which are distinctly longer than the maximum diameter of the eye. (Madagascar) *alluaudi*
- Postpetiole unarmed dorsally, without a median spine (Figs 51–55). Petiole with a pair of lobes or short teeth which are distinctly shorter than the maximum diameter of the eye 2
- 2 Petiole node in profile produced into a very high thin plate-like prominence above (Fig. 51). In anterior view the petiole broadly bilobate dorsally. (Seychelles) *scotti*
- Petiole node in profile roughly triangular in shape, tapering dorsally. In anterior view the petiole emarginate to bidentate dorsally 3
- 3 Postpetiole in profile rising to a sharp point or peak dorsally; in dorsal view this peak seen to be the dorsalmost point of a sharp, knife-edged, transverse crest which slopes away on each side (Figs 52, 53) 4
- Postpetiole in profile bluntly rounded dorsally; in dorsal view without a knife-edged transverse crest (Figs 54, 55) 5

- 4 Lateral marginations of pronotum projecting into a broad semitranslucent lamina on each side (Fig. 52). Larger species, HW > 1.50, PW > 1.30. (Madagascar) . . . . . *xaltus*
- Lateral marginations of pronotum merely a sharp angle, not projecting into broad laminae (Fig. 53). Smaller species, HW < 1.50, PW < 1.30. (Madagascar) . . . . . *rufipes*
- 5 Posterior half of first gastral tergite densely reticulate. Lateral marginations of pronotum reduced, blunt and rounded, no sharper than the coarse sulci which make up the sculpture. Metanotal groove extremely deep, the anterior face of the propodeum concave so that the anterodorsal angle of the propodeum overhangs the base of the metanotal groove (Fig. 55). (Madagascar) . . . . . *foreli*
- Posterior half of first gastral tergite smooth. Lateral marginations of pronotum sharp, very distinctive and much sharper than the pronotal sculpture. Metanotal groove present but shallow, unspecialized (Fig. 54). (Madagascar) . . . . . *steinheili*

## Acknowledgements

My profound thanks and gratitude for the loan of types and other important material necessary to complete this study go to Dr Paul H. Arnaud (CAS, San Francisco); Dr Claude Besuchet (MHN, Geneva); Prof. William L. Brown (Cornell University, Ithaca, New York); Mrs Cathy Car (NM, Bulawayo); Dr Jean Decelle (MRAC, Tervuren); Mrs Marjorie Favreau (AMNH, New York); Dr Eberhard Königsmann (MNHU, Berlin); Dr Roberto Poggi (MCSN, Genoa); Dr A. G. Radchenko (ZM, Kiev); Dr David R. Smith (USNM, Washington); Mrs Margaret K. Thayer (MCZ, Cambridge); Dr Cesare Baroni Urbani (NM, Basle); Mme J. Casevitz Weulersse (MNHN, Paris).

## References

- André, E. 1889. Hyménoptères nouveaux appartenant au groupe des formicides. *Revue Ent.* **8**: 217–231.
- 1905. Description d'un genre nouveau et de deux espèces nouvelles de fourmis d'Australie. *Revue Ent.* **24**: 205–208.
- Arnold, G. 1916. A monograph of the Formicidae of South Africa, part 2. *Ann. S. Afr. Mus.* **14**: 159–270, pls 2–4.
- 1926. A monograph of the Formicidae of South Africa, appendix. *Ann. S. Afr. Mus.* **23**: 191–295, figs 60–82.
- 1952. The genus *Terataner* Emery. *J. ent. Soc. sth. Afr.* **15**: 129–131, fig.
- Bernard, F. 1952. La réserve naturelle intégrale du Mt. Nimba, part 11 Hyménoptères Formicidae. *Mém. Inst. fr. Afr. noire* **19**: 165–270, 3 pls, 15 figs.
- Bolton, B. 1973a. The ant genera of West Africa: a synonymic synopsis with keys. *Bull. Br. Mus. nat. Hist. (Ent.)* **27**: 317–368, 1 fig.
- 1973b. A remarkable new arboreal ant genus from West Africa. *Entomologist's mon. Mag.* **108**: 234–237, 3 figs.
- 1976. The ant tribe Tetramoriini. Constituent genera, review of smaller genera and revision of *Triglyphothrix* Forel. *Bull. Br. Mus. nat. Hist. (Ent.)* **34**: 281–379, 73 figs.
- 1980. The ant tribe Tetramoriini. The genus *Tetramorium* Mayr in the Ethiopian zoogeographical region. *Bull. Br. Mus. nat. Hist. (Ent.)* **40**: 193–384, 145 figs.
- 1981. Revision of the ant genera *Meranoplus* F. Smith, *Dicroaspis* Emery, and *Calyptomyrmex* Emery in the Ethiopian zoogeographical region. *Bull. Br. Mus. nat. Hist. (Ent.)* **42**: 43–81, 44 figs.
- Brown, W. L. 1953. Characters and synonymies among the genera of ants, part 1. *Breviora* no. 11: 1–13.
- 1971. Characters and synonymies among the genera of ants, part 4. Some genera of subfamily Myrmicinae. *Breviora* no. 365: 1–5.
- 1973. A comparison of the Hylean and Congo-West African rain forest ant faunas, pp. 161–185. In Meggers, B. J., Ayensu, E. S., Duckworth, W. D., *Tropical forest ecosystems in Africa and South America, a review*. Washington, D.C.
- Donisthorpe, H. StJ. K. 1931. Descriptions of some new species of ants. *Ann. Mag. nat. Hist. (10)* **8**: 494–501.
- 1933. Descriptions of three new species of Formicidae and a synonymical note. *Ann. Mag. nat. Hist. (10)* **11**: 194–198.
- 1946. A new genus and species of Formicidae from Mauritius. *Proc. R. ent. Soc. Lond. (B)* **15**: 145–147, 4 figs.
- Emery, C. 1886. Alcune formiche africane. *Boll. Soc. ent. ital.* **18**: 355–366, pl. 17.
- 1891. Voyage de M. Ch. Alluaud dans le territoire d'Assinie (Afrique occidentale) en juillet et août 1886. *Annls Soc. ent. Fr.* **60**: 553–574, pl. 15.



- 1892. Sopra alcune formiche raccolte dall'Ingegnere L. Bricchetti Robecchi nel paese dei Somali. *Annali Mus. civ. Stor. nat. Genova* (2) **12**: 110–122, figs.
- 1895. Mission scientifique de M. Ch. Alluaud dans le territoire de Diego-Suarez (Madagascar-Nord). *Anns Soc. ent. Belg.* **39**: 336–345, 3 figs.
- 1896. Formiche raccolte dal Cap. V. Bottego nella regione dei Somali. *Annali Mus. civ. Stor. nat. Genova* (2) **17**: 153–160, figs.
- 1899. Fourmis d'Afrique. *Anns Soc. ent. Belg.* **43**: 459–504, figs.
- 1900. Formiche di Madagascar raccolte dal Sig. A. Mocquerys nei pressi della Baia di Antongil (1897–1898). *Boll. Soc. ent. ital.* **31**: (1899): 263–290, figs.
- 1912. Études sur les Myrmicinae. *Anns Soc. ent. Belg.* **56**: 94–105, 5 figs.
- 1922. In Wytzman, P. A. G., *Genera Insect. Hym. fam. Formicidae subfam. Myrmicinae. fasc. 174c*: 207–397.
- Forel, A.** 1895. Quelques fourmis du centre de Madagascar. *Anns Soc. ent. Belg.* **39**: 485–488.
- 1901. Einige neue Ameisen aus Südbrasilien, Java, Natal und Mossamedes. *Mitt. schweiz. ent. Ges.* **10**: 297–310.
- 1910a. Note sur quelques fourmis d'Afrique. *Anns Soc. ent. Belg.* **54**: 421–458.
- 1910b. In Schultze, L. S., *Zoologische und anthropologische Ergebnisse einer Forschungsreise im westlichen und zentralen Südafrika*. Formicidae: 1–30.
- 1911. Ameisen des Herrn Prof. v. Ihering aus Brasilien (São Paulo usw.) nebst einigen anderen aus Südamerika und Afrika. *Dt. ent. Z* **1911**: 285–312.
- 1912. The Percy Sladen expedition to the Indian Ocean in 1905, no. 11. Fourmis des Seychelles et des Aldabras, reçues de M. Hugh Scott. *Trans. Linn. Soc. Lond.* **15**: 159–167.
- 1913a. Formicides du Congo Belge récoltés par MM. Bequaert, Luja, etc. *Revue Zool. Bot. afr.* **2**: 306–351.
- 1913b. Fourmis de Rhodesia etc. récoltées par M. G. Arnold, le Dr H. Brauns et K. Fikendey. *Anns Soc. ent. Belg.* **57**: 108–147.
- 1913c. Wissenschaftliche Ergebnisse einer Forschungsreise nach Ostindien, ausgeführt im Auftrage der Kgl. Preuss. Akademie der Wissenschaften zu Berlin von H. v. Buttel-Reepen, 2. Ameisen aus Sumatra, Java, Malacca und Ceylon. Gesammelt von Herrn Prof. Dr v. Buttel-Reepen in den Jahren 1911–1912. *Zool. Jb. Syst.* **36**: 1–148, figs.
- Karavaiev, V.** 1931. Ameisen aus Englisch-Ostafrika. *Zool. Anz.* **95**: 42–51, 7 figs.
- Kempf, W. W.** 1972. Catálogo abreviado das formigas da Regiao Neotropical. *Studia ent.* **15**: 3–344.
- Kugler, C.** 1978. A comparative study of the myrmicine sting apparatus. *Studia ent.* **20**: 413–548, 244 figs.
- Mann, W. M.** 1919. The ants of the British Solomon Islands. *Bull. Mus. comp. Zool. Harv.* **63**: 271–391, 59 figs.
- Mayr, G.** 1866. Diagnosen neuer und wenig gekannter Formiciden. *Verh. zool.-bot. Ges. Wien* **16**: 885–908, pl. 20.
- 1895. Afrikanische Formiciden. *Annl. naturh. Mus. Wien* **10**: 124–154, 3 figs.
- Menozi, C.** 1942. Formiche dell'isola Fernando Po e del territorio del Rio Muni (Guinea Spagnola). *Zool. Anz.* **140**: 164–182, 4 figs.
- Prins, A. J.** 1965. African Formicidae. Description of a new species. *S. Afr. J. agric. Sci.* **8**: 1021–1024, 2 figs.
- Santschi, F.** 1910. Deux nouvelles fourmis du Tonkin. *Naturaliste* **32**: 283–284.
- 1911. Nouvelles fourmis du Congo et du Benguela. *Revue Zool. Bot. afr.* **1**: 204–217.
- 1913. Mélanges myrmécologiques. *Anns Soc. ent. Belg.* **57**: 429–437.
- 1914a. Meddelanden från Göteborgs Musei Zoologiska Afdeling no. 3. Fourmis du Natal et du Zululand récoltées par le Dr I. Trägårdh; avec un appendice: Notes biologiques par I. Trägårdh. *Göteborgs K. Vetensk.-o. VitterhSamh. Handl.* **15**: 1–47, 10 figs.
- 1914b. Formicides de l'Afrique occidentale et australe du voyage de M le Professeur F. Silvestri. *Bull. Lab. Zool. gen. agr. Portici* **8**: 307–385, 34 figs.
- 1916. Description d'un nouveau formicide de l'Afrique occidentale. *Bull. Soc. ent. Fr.* **1916**: 50–51, 1 fig.
- 1923. Descriptions de nouveaux formicides éthiopiens et notes diverses 1. *Revue Zool. Bot. afr.* **11**: 259–295, 5 figs.
- 1924. Descriptions de nouveaux formicides africains et notes diverses 2. *Revue Zool. Bot. afr.* **12**: 195–224, 10 figs.
- 1930. Formicides de l'Angola. *Revue suisse Zool.* **37**: 53–82, 10 figs.
- 1932. Formicides sud-africains. *Soc. ent. Fr. Livre du centenaire, 1932*: 381–392, 12 figs.
- Smith, M. R.** 1947. A new genus and species of ant from Guatemala. *Jl N.Y. ent. Soc.* **55**: 281–284, 2 figs.
- Stitz, H.** 1923. Beiträge zur Kenntnis der Land- und Süßwasserfauna Deutsch-Südwestafrikas. Ergebnisse der Hamburger deutsch-südwestafrikanischen Studienreise 1911. Hymenoptera **7** Formicidae: 143–167, 2 figs. Hamburg.

- Taylor, R. W.** 1965. The Australian ants of the genus *Pristomyrmex*, with a case of apparent character displacement. *Psyche, Camb.* **72**: 35–54, 15 figs, 1 pl.
- 1968. A supplement to the revision of Australian *Pristomyrmex* species. *J. Aust. ent. Soc.* **7**: 63–66, 2 figs.
- 1970. Characterization of the Australian endemic ant genus *Peronomyrmex* Viehmeyer. *J. Aust. ent. Soc.* **9**: 209–211, 3 figs.
- Weber, N. A.** 1941. Four new genera of Ethiopian and Neotropical Formicidae. *Ann. ent. Soc. Am.* **34**: 183–194, 12 figs.
- 1943. Ants of the Imatong Mountains, Anglo-Egyptian Sudan. *Bull. Mus. comp. Zool. Harv.* **93**: 261–389, 16 pls.
- 1952. Studies on African Myrmicinae, 1. *Am. Mus. novit.* no. 1548: 1–32, 36 figs.
- Wheeler, W. M.** 1919. The ants of Borneo. *Bull. Mus. comp. Zool. Harv.* **63**: 43–147.
- 1922. Ants of the Belgian Congo, parts 1–8. *Bull. Am. Mus. nat. Hist.* **45**: 1–1139, 23 pls, 76 figs.
- Wilson, E. O.** 1976. Which are the most prevalent ant genera? *Studia ent.* **19**: 187–200.

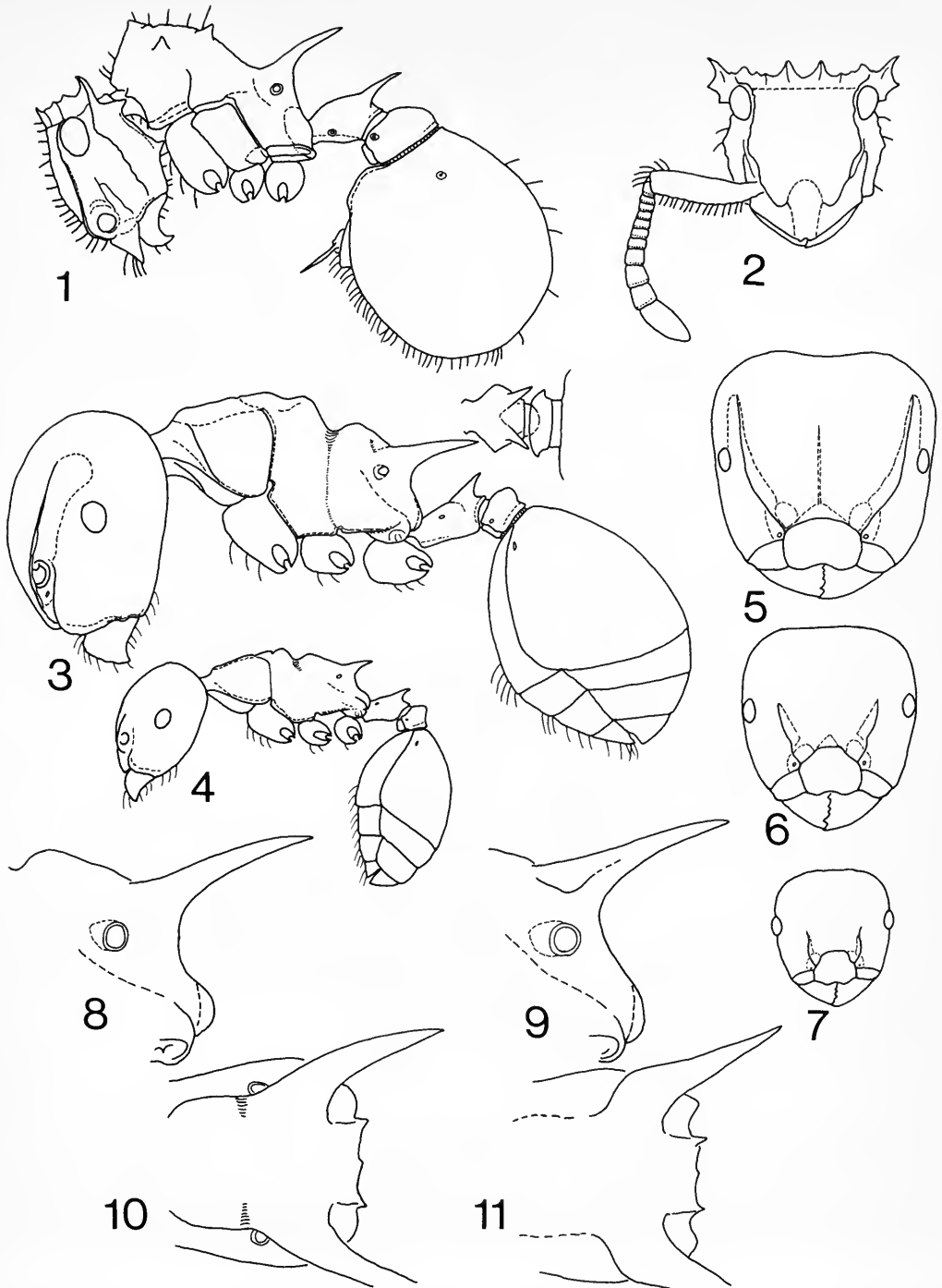

Figs 1–11 1, 2. *Ankylomyrma* worker. 1, profile of *coronacantha*, 2, head of *coronacantha*. 3–11. *Atopomyrmex* workers. 3, profile of large worker of *mocquerysi*, 4, profile of small worker of *mocquerysi*. 5–7, heads of *mocquerysi* workers: (5) large (HW 2.20), (6) medium (HW 1.90), (7) small (HW 1.30). 8, 9, propodeal profile of (8) *mocquerysi*, (9) *cryptoceroides*. 10, 11, propodeal dorsum of (10) *mocquerysi*, (11) *cryptoceroides*. Sculpture omitted.

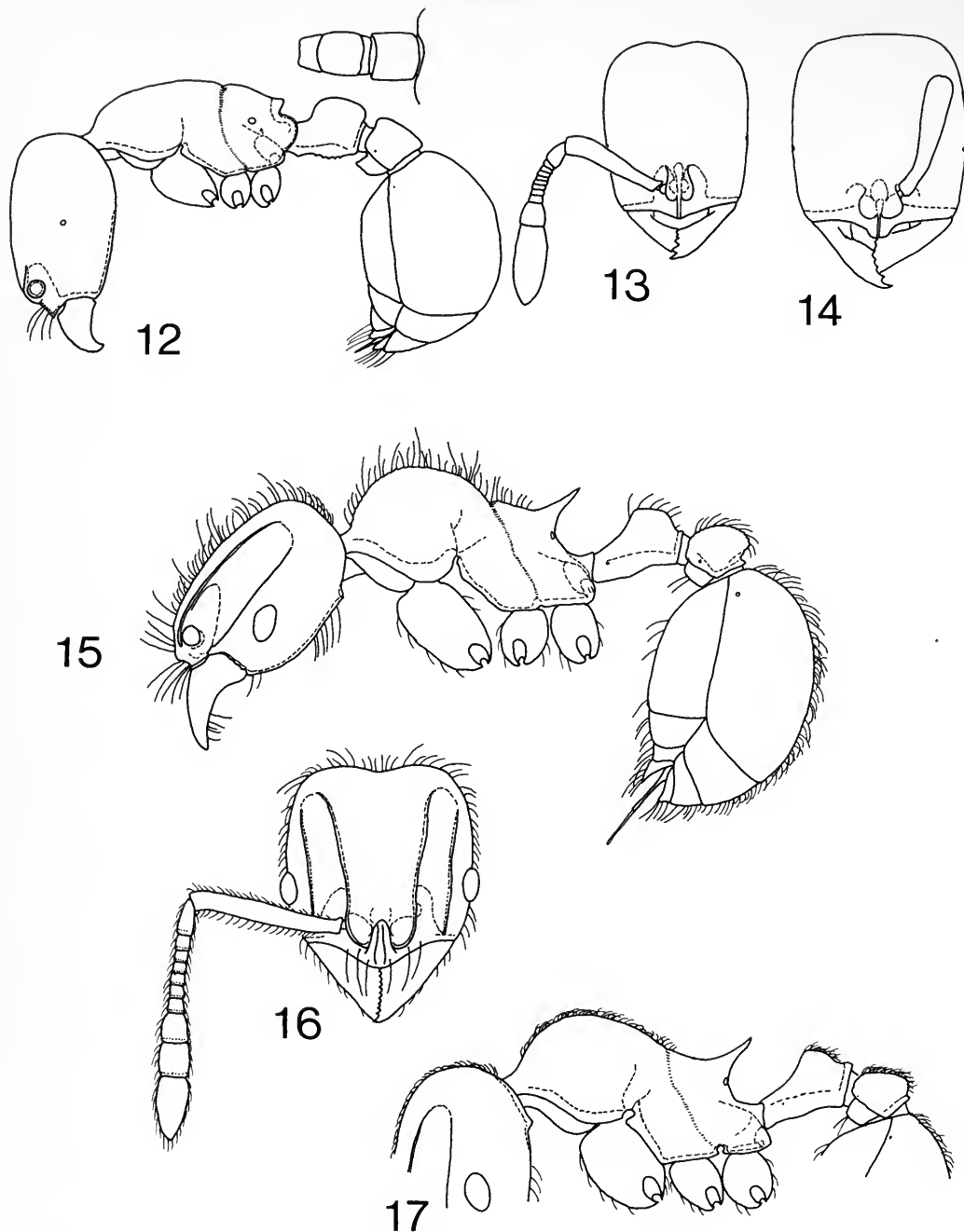

Figs 12–17 12–14. *Baracidris* workers. 12, profile of *meketra*. 13, 14 heads of (13) *meketra*, (14) *sitra*. 15–17 *Cyphoidris* workers. 15, profile of *spinosa*. 16, head of *spinosa*. 17, alitrunk and pedicel of *exalta*. Sculpture omitted.

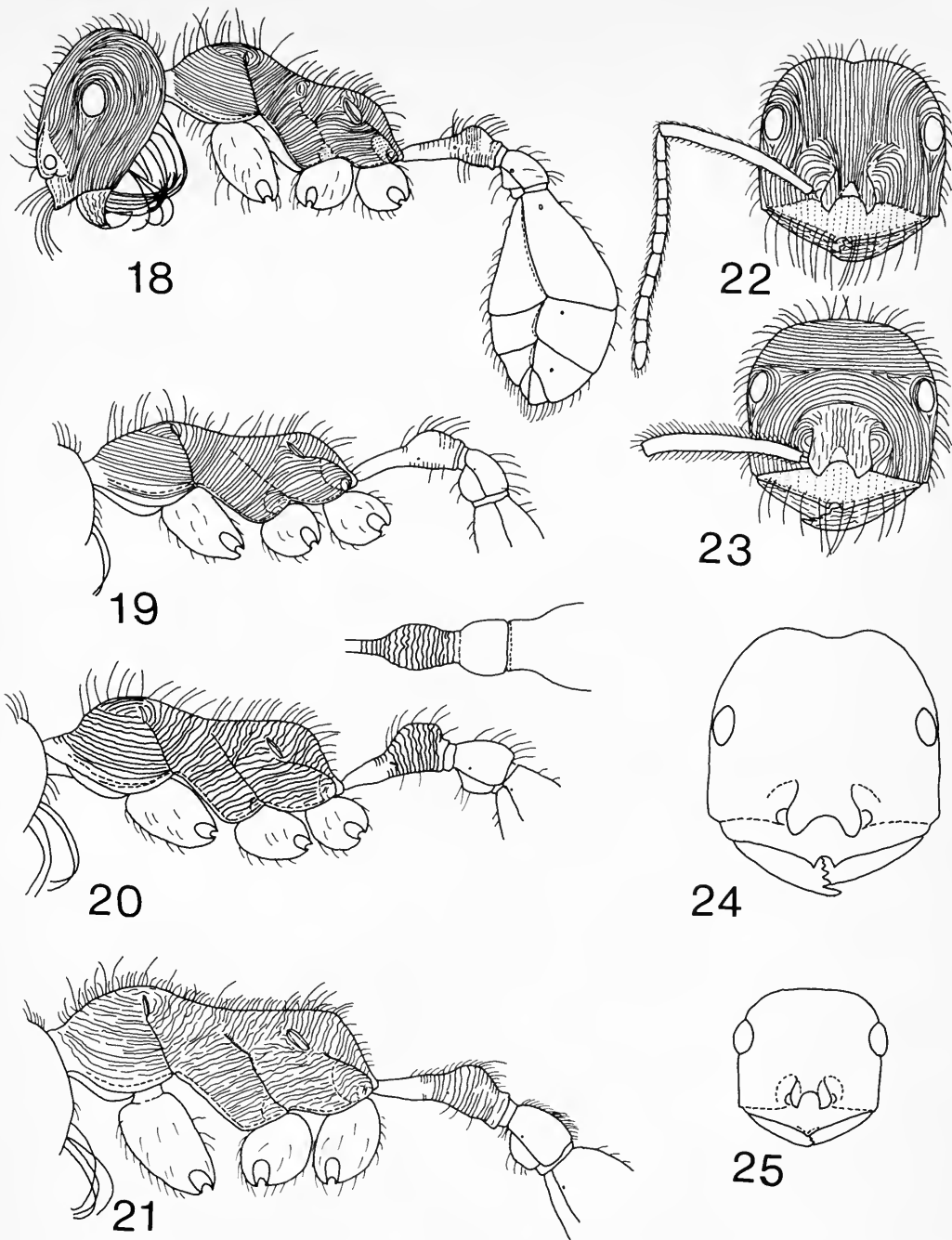

**Figs 18–25** *Ocymyrmex* workers. 18, profile of *nitidulus*. 19–21, alitrunk and pedicel segments of (19) *celer*, (20) *sobek*, (21) *sphinx*. 22–25, head of (22) *nitidulus* worker, (23) *nitidulus* female, (24) *robecchii*, (25) *turneri*. Sculpture omitted in 24, 25.

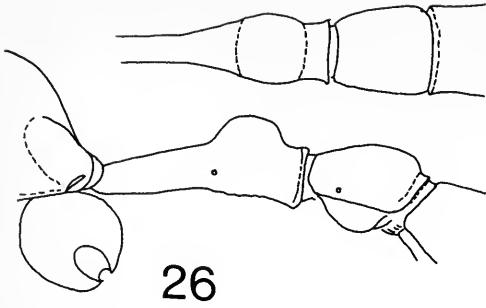

26

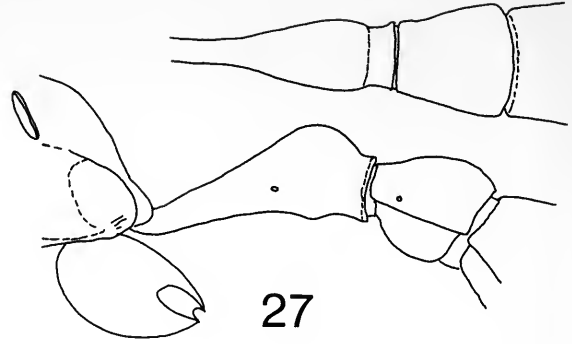

27

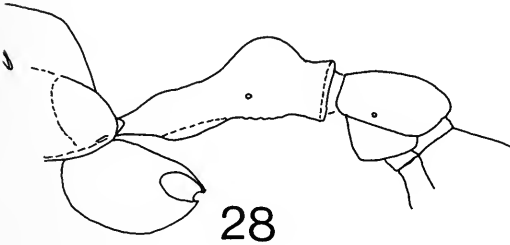

28

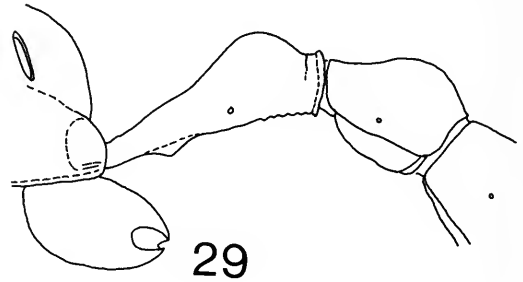

29

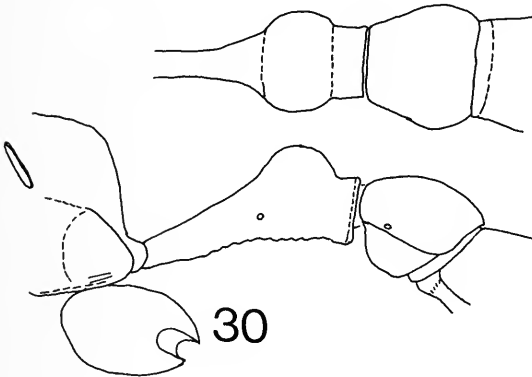

30

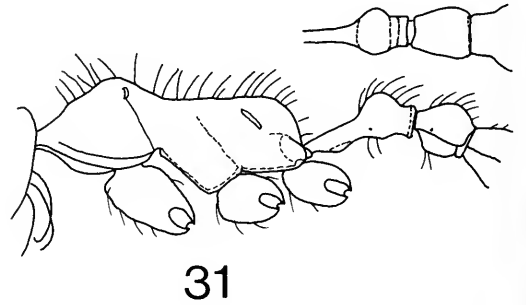

31

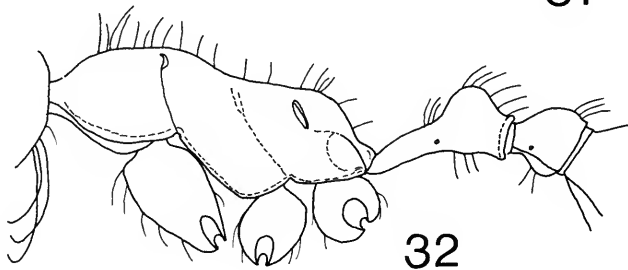

32

Figs 26–32 *Ocymyrmex* workers. 26–30, pedicel segments of (26) *fortior*, (27) *phraxus*, (28) *flaviventris*, (29) *laticeps*, (30) *weitzckeri*. 31, 32, alitrunk and pedicel segments of (31) *shushan*, (32) *velox*. Sculpture omitted.

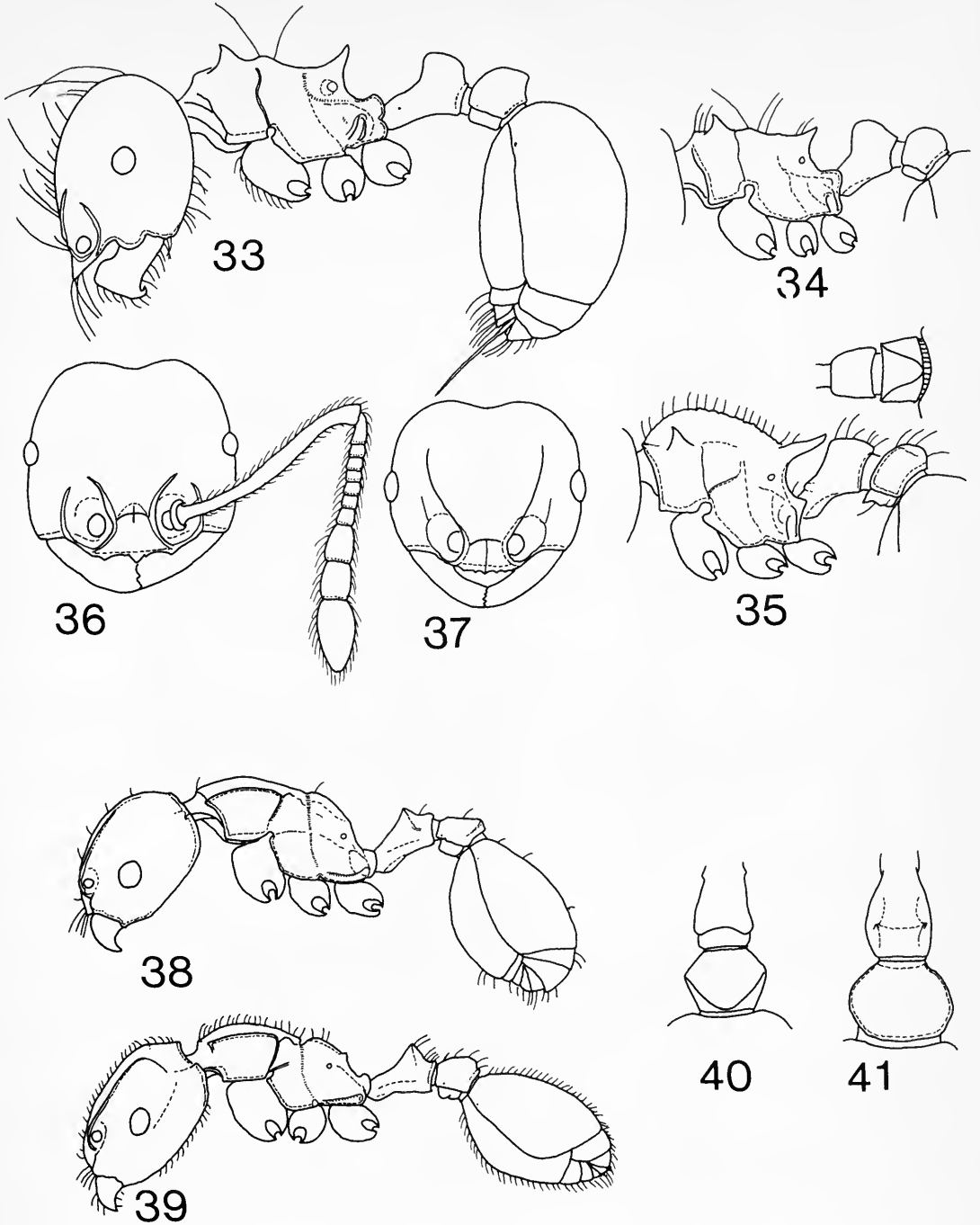

**Figs 33–41** 33–37. *Pristomyrmex* workers. 33, profile of *trogor*. 34, 35, alitrunk and pedicel segments of (34) *africanus*, (35) *cribrarius*. 36, 37, heads of (36) *trogor*, (37) *orbiceps*. 38–41. *Terataner* workers. 38, 39, profiles of (38) *luteus*, (39) *bottegoi*. 40, 41, pedicel in dorsal view of (40) *piceus*, (41) *elegans*. Sculpture omitted.

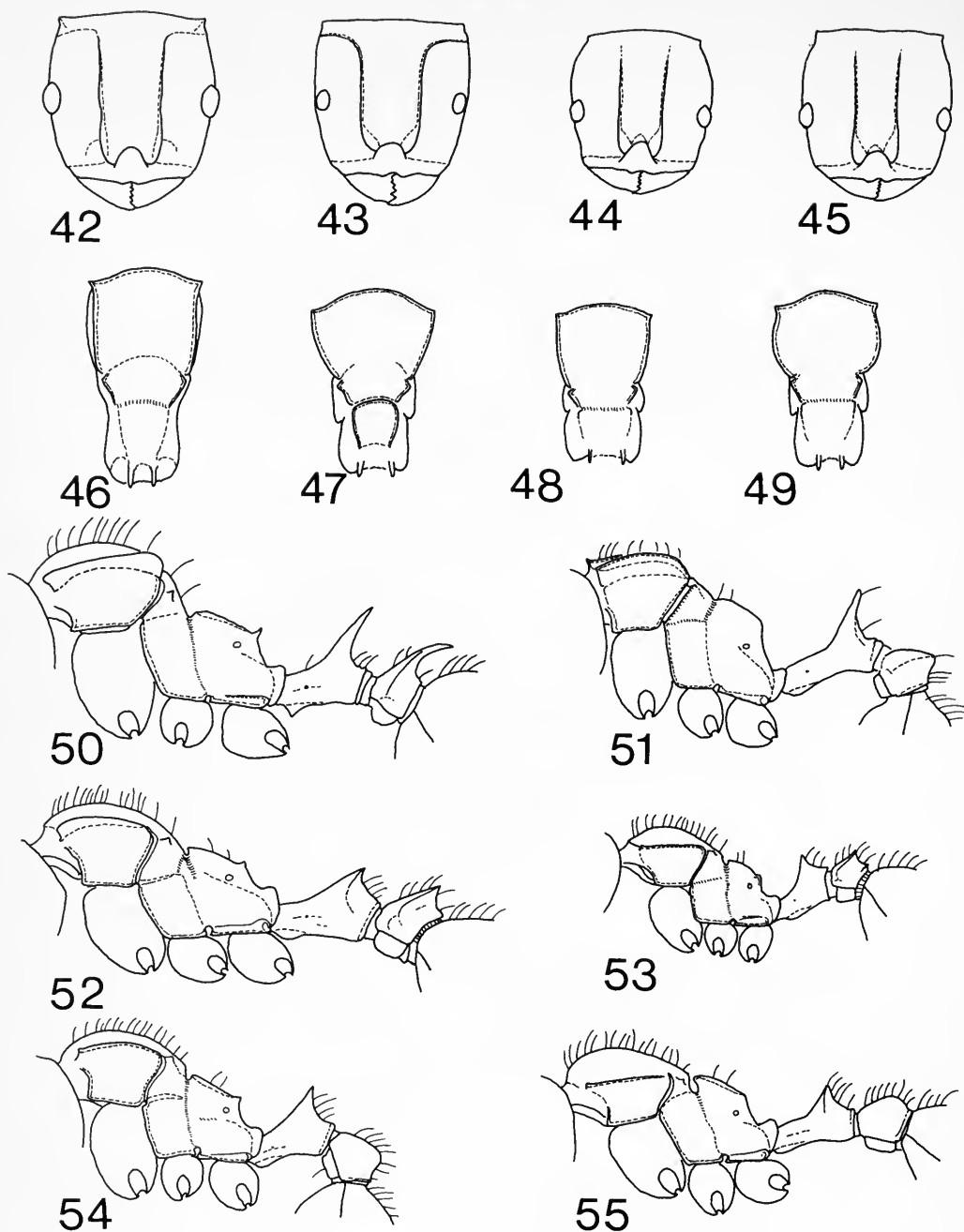

Figs 42–55 *Terataner* workers. 42–45, heads of (42) *transvaalensis*, (43) *bottegoi*, (44) *luteus*, (45) *elegans*. 46–49, dorsal alitrunk of (46) *transvaalensis*, (47) *bottegoi*, (48) *elegans*, (49) *luteus*. 50–55, alitrunk and pedicel of (50) *alluaudi*, (51) *scotti*, (52) *xaltus*, (53) *rufipes*, (54) *steinheili*, (55) *foreli*. Sculpture omitted.



## Index

Synonyms are in *italics*.

- abdominalis* 269  
*africanus* 284  
*alluaudi* 296  
*ankhu* 265  
*Ankylomyrma* 247  
*arnoldi* (*Atopomyrmex*) 251  
*arnoldi* (*Ocymyrmex*) 269  
*Atopomyrmex* 249  
*australis* 251  
  
*Baracidris* 252  
*barbatus* 265  
*barbiger* 265  
*beni* 284  
*bottegoi* 291  
  
*carpenteri* 275  
*cavatodorsatus* 266  
*celer* 267  
*coronacantha* 248  
*cribrarius* 285  
*cryptoceroides* 250  
*cursor* 267  
*curvispina* 250  
*Cyphoidris* 256  
  
*deplanatus* 250  
*Dodous* 282  
  
*elegans* 292  
*erigens* 251  
*exalta* 258  
  
*flavescens* 265  
*flaviventris* 268  
*foreli* (*Ocymyrmex*) 269  
*foreli* (*Terataner*) 296  
*fortior* 269  
*fossulatus* 285  
  
*hirsutus* 271  
*Hylidris* 282  
  
*laevigatus* 286  
*laticeps* 271  
*luteus* 293  
  
*mbomu* 284  
*meketra* 255  
*melanoticus* 250  
*micans* 272  
  
*mocquersyi* 251  
*monardi* 273  
*myersi* 284  
  
*nigellus* 251  
*nitidulus* 274  
  
*obscura* 251  
*Ocymyrmex* 260  
*Odontomyrmex* 282  
*opaca* 251  
*orbiceps* 286  
  
*parissa* 258  
*phraxus* 274  
*picardi* 275  
*piceus* 293  
*primus* 284  
*Pristomyrmex* 282  
  
*robecchii* 276  
*robustior* 265  
*rufipes* 296  
  
*scotti* 296  
*shushan* 277  
*sitra* 256  
*sobek* 277  
*sphinx* 278  
*spinosa* 257  
*steinheili* 296  
  
*Terataner* 288  
*Tranetera* 288  
*transvaalensis* 294  
*transversus* 269  
*trogor* 287  
*turneri* 279  
  
*usakosensis* 269  
  
*velatus* 295  
*velox* 280  
  
*weitzeckeri* 280  
*weneri* 259  
*wroughtoni* 280  
  
*xaltus* 296  
  
*zekhem* 281



# British Museum (Natural History) 1881–1981

## Centenary Publications

### **The Natural History Museum at South Kensington**

By *W. T. Stearn*

This book presents a full history of the Museum, its collections, Directors and eminent members of staff. It provides for the first time an account of the major research undertaken and insights into the personalities of the key people in the Museum's development and evolution.

Co-published with William Heinemann.

### **Alfred Waterhouse and the Natural History Museum**

By *Mark Girouard*

Designed by Alfred Waterhouse in the 1870's the Museum is surely one of London's most outstanding pieces of architecture.

This attractively illustrated book describes the development of the design and highlights some of the building's most interesting features.

### **British Museum Natural History**

By *Peter Whitehead & Colin Keates*

The Museum is really a huge scientific research institution – acquiring, describing and classifying all manner of natural history material, both specimens and artworks. It has some of the richest collections of their kind in the world and it is these and how they are obtained and managed that are the subject of this book. The lavish, full colour illustrations and lively text will appeal to everybody interested in natural history.

Co-published with Philip Wilson Ltd.

### **Chance, Change and Challenge**

This multi-author twin volume work is one of the Museum's most ambitious publishing projects. In the first volume *The Evolving Earth* twenty scientists have been asked to summarise the present state of knowledge in their particular field, ranging from the origin of the Earth, through ocean sediments and soils to continental drift and palaeogeography.

In the companion volume *The Evolving Biosphere* Museum scientists have chosen an evolutionary concept – speciation, coevolution, biogeography etc and related this to the group of animals or plants in which they are specialising.

Co-published with Cambridge University Press.

### **Animal Identification—A Reference Guide**

VOLUME 1: MARINE AND BRACKISH WATER. *Edited by R. W. Sims.*

VOLUME 2: TERRESTRIAL AND FRESHWATER. *Edited by R. W. Sims.*

VOLUME 3: INSECTS. *Edited by D. Hollis.*

These guides provide the reader with lists of primary sources of reference that can be used to identify (or lead to the identification of) living animals throughout the world. The references are arranged in systematic and geographical sequence in order to facilitate searching.

Co-published with John Wiley & Sons Limited.

### **Nature Stored Nature Studied**

A short guide complementing the exhibition of that name to be staged in the Museum throughout 1981. It gives a fascinating insight into the history of the Museum collections and the research carried out "behind the scenes".

## **Titles to be published in Volume 43**

**A revision of the genus *Usambilla* Sjöstedt (Orthoptera: Acridoidea) and its allies.**

By N. D. Jago.

**The Asian, Australasian and Pacific Paraboloponinae (Homoptera: Cicadellidae).  
A taxonomic revision with a key to all the known genera of the subfamily.**

By M. D. Webb.

**A revision of *Phyciodes* Hübner and related genera, with a review of the classification  
of the Melitaeinae (Lepidoptera: Nymphalidae). By L. G. Higgins.**

**A revision of six minor genera of Myrmicinae (Hymenoptera: Formicidae) in the Ethio-  
pian zoogeographical region. By Barry Bolton.**







